



HEIDENHAIN



Product Information

ECN 1313

ECN 1325

ERN 1321

ERN 1387

Rotary Encoders with
Plane-Surface Coupling
for Elevator Servo Drive
Control

October 2013

ECN/ERN 1300 series

Rotary Encoders with integral bearings for elevator technology



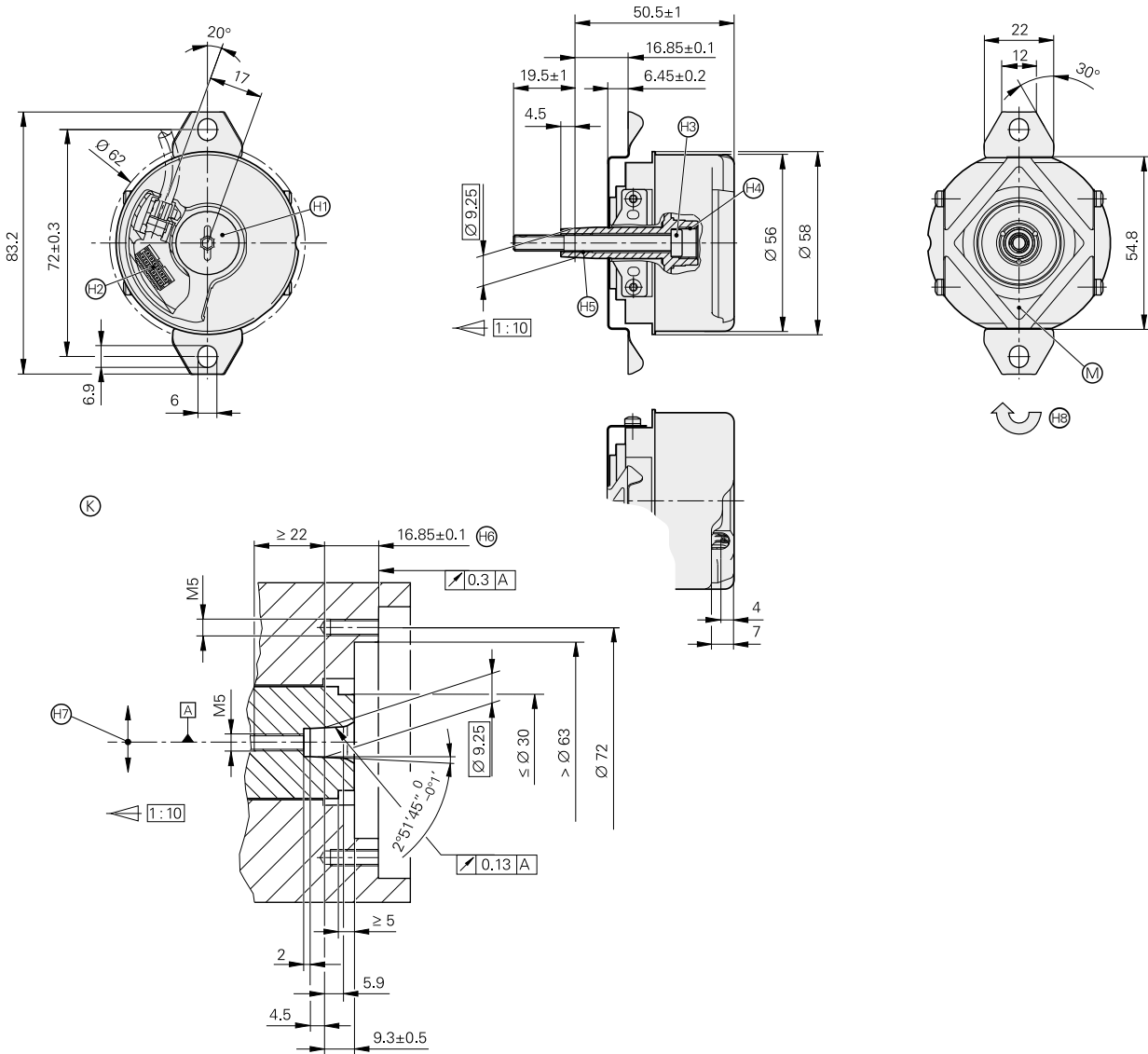

- Simple installation
- Rigid shaft coupling
- Plane-surface coupling for large mounting tolerances
- Uniform dimensions for various interfaces

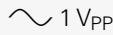

mm

 Tolerancing ISO 8015
 ISO 2768 - m H
 < 6 mm: ±0.2 mm

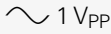
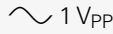
- ▣ = Bearing of mating shaft
- ▣ = Bearing of encoder
- ⊙ = Required mating dimensions
- ⊙ = Measuring point for operating temperature
- ⊙ = Screw plug, widths A/F 3 and 4, tightening torque 5+0.5 Nm
- ⊙ = 12-pin PCB connector
- ⊙ = Self-tightening screw M5 x 50 DIN 6912 SW4, tightening torque 5 +0.5 Nm
- ⊙ = M10 back-off thread
- ⊙ = M6 back-off thread
- ⊙ = Max. permissible tolerance with moving motor shaft ± 1.5
- ⊙ = Max. permissible static radial offset of motor shaft in indicated direction ± 0.13 mm
- ⊙ = Direction of scanning unit motion for output signals in accordance with interface description

	Absolute		Incremental	
	ECN 1325	ECN 1313	ERN 1387	ERN 1321
Interface¹⁾	EnDat 2.2		 1 V _{PP}	
Ordering designation	EnDat22	EnDat01	–	
Position values/rev	33554432 (25 bits)	8192 (13 bits)	Z1 track ³⁾	–
Elec. permissible speed/ Deviation ²⁾	≤ 12000 min ⁻¹ (for continuous position value)	≤ 1500 min ⁻¹ /± 1 LSB ≤ 12000 min ⁻¹ /± 50 LSB	–	
Calculation time t _{cal} Clock frequency	≤ 7 μs ≤ 8 MHz	≤ 9 μs ≤ 2 MHz	–	
Incremental signals ¹⁾	–	 1 V _{PP}	 1 V _{PP}	
Line count*/ system accuracy	2048/± 20"		2048/± 20"	1024/± 64" 2048/± 32" 4096/± 16" 5000/± 13"
Reference mark	–		One	
Cutoff frequency –3 dB	–	≥ 400 kHz	≥ 210 kHz	–
Scanning frequency Edge separation	–		–	≤ 300 kHz ≥ 0.35 μs
Electrical connection Via PCB connector	<i>Rotary encoder</i> : 12-pin <i>Temperature sensor⁴⁾</i> : 4-pin	12-pin	14-pin	12-pin
Voltage supply	3.6 V to 14 V DC		5 V ± 0.25 V	5 V ± 0.5 V
Power consumption ¹⁾ (maximum)	3.6 V: ≤ 600 mW 14 V: ≤ 700 mW		–	–
Current consumption	5 V: 85 mA (typical, without load)		≤ 130 mA (without load)	≤ 120 mA (without load)
Stator coupling	Plane-surface coupling			
Shaft	Taper shaft Ø 9.25 mm; taper 1:10			
Mech. permissible speed n	≤ 12000 min ⁻¹			
Starting torque	≤ 0.01 Nm (at 20 °C)			
Moment of inertia of rotor	2.6 · 10 ⁻⁶ kgm ²			
Permissible axial motion of measured shaft ⁵⁾	± 1.5 mm			
Radial runout of the measured shaft	0.13 mm (static, radial offset ± 0.13 mm)			
Vibration 55 to 2000 Hz Shock 6 ms	≤ 300 m/s ²⁶⁾ (EN 60 068-2-6) ≤ 2000 m/s ² (EN 60 068-2-27)			
Operating temperature	–40 °C to 115 °C		–40 °C to 120 °C	
Protection EN 60529	IP 40 when mounted			
Weight	Approx. 0.25 kg			

* Please select when ordering

¹⁾ See catalog: *Interfaces of HEIDENHAIN Encoders*

²⁾ Speed-dependent deviations between the absolute value and incremental signal

³⁾ One sine and one cosine signal per revolution

⁴⁾ Evaluation optimized for KTY 84-130

⁵⁾ Compensation of mounting tolerances and thermal expansion, no dynamic motion

⁶⁾ As per standard for room temperature; the following applies for operating temperature

Up to 100 °C: ≤ 300 m/s²
Up to 115 °C or 120 °C: ≤ 150 m/s²

Electrical connection

Pin layouts

ECN 1313 pin layout

17-pin coupling or flange socket M23						12-pin PCB connector								
	Voltage supply					Incremental signals ¹⁾				Absolute position values				
	7	1	10	4	11	15	16	12	13	14	17	8	9	
	12	1b	6a	4b	3a	/	2a	5b	4a	3b	6b	1a	2b	5a
	U _P	Sensor U _P	0V	Sensor 0V	Internal shield	A+	A-	B+	B-	DATA	DATA	CLOCK	CLOCK	
	Brown/ Green	Blue	White/ Green	White	/	Green/ Black	Yellow/ Black	Blue/ Black	Red/ Black	Gray	Pink	Violet	Yellow	

Other signals	
5	6
	/
	/
	Brown ²⁾ / White ²⁾



Cable shield connected to housing; **U_P** = power supply voltage; **T** = Temperature
Sensor: The sensor line is connected in the encoder with the corresponding power line.
 Vacant pins or wires must not be used!

- 1) Only with ordering designations EnDat 01 and EnDat 02
- 2) Only with output cables inside the motor
- 3) Connections for external temperature sensor; connection in the M23 flange socket
- 4) **ECI 1118 EnDat 22:** Vacant
- 5) Only EnDat 22, except ECI 1118
- 6) White with M23 flange socket / Green with M12 flange socket

ECN 1325 pin layout

8-pin coupling or flange socket M12					9-pin flange socket M23							
4-pin PCB connector				12-pin PCB connector								
	Voltage supply				Absolute position values				Other signals ³⁾			
	8	2	5	1	3	4	7	6	/	/	/	/
	3	7	4	8	5	6	1	2	/	/	/	/
	/	/	/	/	/	/	/	/	1a	1b	/	/
	1b	6a	4b	3a	6b	1a	2b	5a	/	/	/	/
	U _P	Sensor U _P ⁴⁾	0V	Sensor 0V ⁴⁾	DATA	DATA	CLOCK	CLOCK	T ⁵⁾	T ⁻⁵⁾	T ^{3) 5)}	T ^{-3) 5)}
	Brown/ Green	Blue	White/ Green	White	Gray	Pink	Violet	Yellow	Brown	Green	Brown	⁶⁾

ERN 1321 pin layout

Output cable for ERN 1321 in the motor ID 667343-01				17-pin M23 flange socket				12-pin PCB connector					
	7	1	10	4	15	16	12	13	3	2	5	6	8/9/11/14/17
	2a	2b	1a	1b	6b	6a	5b	5a	4b	4a	/	/	3a/3b
	U_P	Sensor U_P	0V	Sensor 0V	U_{a1}	\overline{U}_{a1}	U_{a2}	\overline{U}_{a2}	U_{a0}	\overline{U}_{a0}	$T^+{}^1$	$T^-{}^1$	Vacant
	Brown/Green	Blue	White/Green	White	Brown	Green	Gray	Pink	Red	Black	Brown ¹⁾	White ¹⁾	/



Cable shield connected to housing; U_P = power supply voltage



Sensor: The sensor line is connected in the encoder with the corresponding power line

Vacant pins or wires must not be used!

¹⁾ Only for encoder cable inside the motor housing

ERN 1387 pin layout

17-pin coupling or flange socket M23					14-pin PCB connector						
	7	1	10	4	11	15	16	12	13	3	2
	1b	7a	5b	3a	/	6b	2a	3b	5a	4b	4a
	U_P	Sensor U_P	0V	Sensor 0V	Internal shield	A+	A-	B+	B-	R+	R-
	Brown/Green	Blue	White/Green	White	/	Green/Black	Yellow/Black	Blue/Black	Red/Black	Red	Black

Other signals						
	14	17	9	8	5	6
	7b	1a	2b	6a	/	/
	C+	C-	D+	D-	$T^+{}^1$	$T^-{}^1$
	Gray	Pink	Yellow	Violet	Green	Brown

Cable shield connected to housing;

U_P = Power supply; T = Temperature

Sensor: The sensor line is connected internally with the corresponding power line.

Vacant pins or wires must not be used!

¹⁾ Only with adapter cables inside the motor

HEIDENHAIN

DR. JOHANNES HEIDENHAIN GmbH

Dr.-Johannes-Heidenhain-Straße 5

83301 Traunreut, Germany

☎ +49 8669 31-0

☎ +49 8669 5061

E-mail: info@heidenhain.de

www.heidenhain.de

This Product Information supersedes all previous editions, which thereby become invalid. The basis for ordering from HEIDENHAIN is always the Product Information valid when the contract is made.

More information

- Catalog: *Position Encoders for Servo Drives*
- Catalog: *Rotary Encoders*
- Catalog: *Interfaces of HEIDENHAIN Encoders*