

SIZE
17
1.57"
SQ

Rotary Hybrid Stepping Motor 1.8°

Conventional

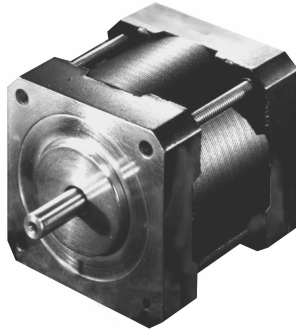

EADmotors Size 17 hybrid DC stepping motors are precision bi-directional devices with position accuracy of $\pm 5\%$ non-cumulative.

Motors are totally enclosed with permanently lubricated ball bearings.

Standard motors have 4 or 6 leads. Motors with 5 or 8 leads can be furnished to meet existing applications.

EADmotors specializes in meeting the individual requirements of each application and offers engineering assistance for your design requirements.

Electrical Ratings

Model Number	Number of Leads	Unipolar Connection					Bipolar Connection					Rotor Inertia (oz-in-sec ²)	Weight (ounces)
		Phase Voltage (VDC)	Phase Current (amps)	Phase Resistance (ohms)	Phase Inductance (mH)	Holding Torque (oz-in)	Phase Voltage (VDC)	Phase Current (amps)	Phase Resistance (ohms)	Phase Inductance (mH)	Holding Torque (oz-in)		
ZB17GBK-10	6	4.00	0.95	4.20	2.9	13.9	5.60	0.67	8.40	11.6	19	0.00024	7
ZB17GBK-11	6	6.00	0.63	9.60	4.90	13.9	8.50	0.45	19.20	19.60	19		
ZB17GBK-12	6	12.00	0.32	38.40	22	13.9	17.00	0.23	76.80	88.0	19		
ZB17GBK-200	4						1.90	2.00	0.95	1.40	19		
ZB17EBK-10	6	4.00	1.10	3.50	2.50	19	5.60	0.78	7.00	10.00	24.5	0.00035	7.7
ZB17EBK-11	6	6.00	0.80	7.50	5.30	19	8.50	0.57	15.00	21.20	24.5		
ZB17EBK-12	6	12.00	0.40	30.00	27.3	19	17.00	0.28	60.00	109.2	24.5		
ZB17EBK-200	4						2.40	2.00	1.20	2.40	24.5		
ZB17BBK-10	6	4.00	1.20	3.30	3.2	28.3	5.90	0.85	6.60	12.8	35	0.00051	10.6
ZB17BBK-11	6	6.00	0.92	6.50	6.0	28.3	8.50	0.65	13.00	24.0	35		
ZB17BBK-12	6	12.00	0.46	36.00	23.5	28.3	17.00	0.33	52.00	94.0	35		
ZB17BBK-200	4						2.75	2.00	1.38	2.70	35		

Solutions in motion



Rotary Hybrid Stepping Motor 1.8°

Conventional

SIZE
17
1.57"
SQ

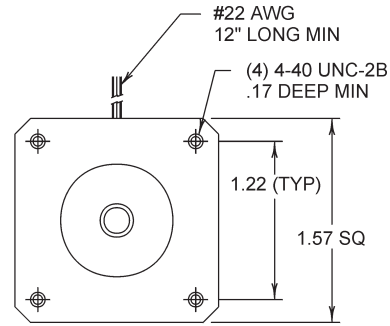
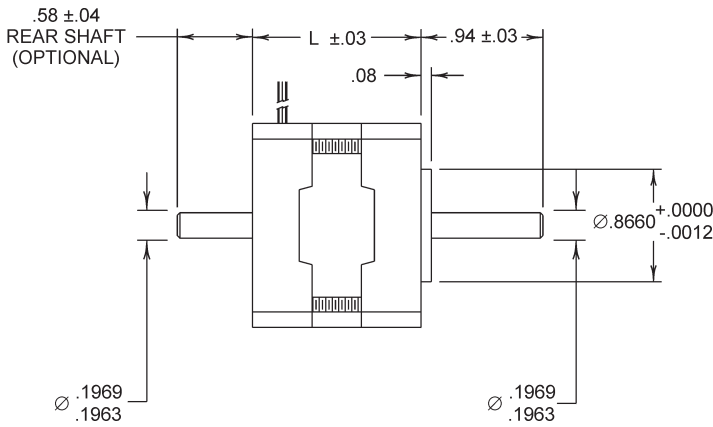

Size 17

Model Series	Dimension "L" (inches)
ZB17GBK	1.30
ZB17EBK	1.54
ZB17BBK	1.85

See page 38 for Connection Diagrams.
For the rear shaft option, use the suffix "R" (for example, ZB17GBK-10R).

Pullout Torque Speed Curves

Typical Unipolar Performance (6 Lead Motor): Constant Voltage Drive (L/R), 2 Phase On

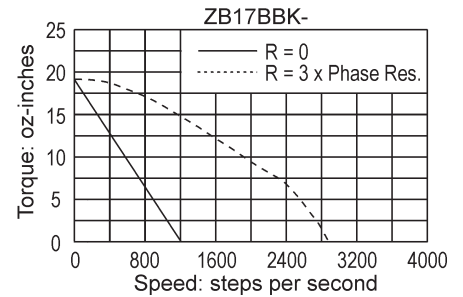
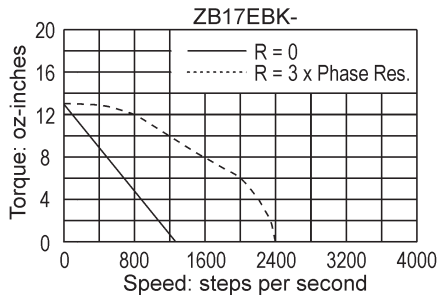
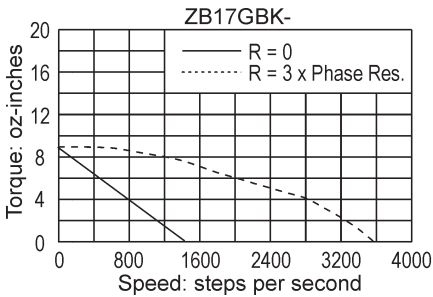

Typical Bipolar Performance: 40 VDC Power Supply, 2 Amp/Phase

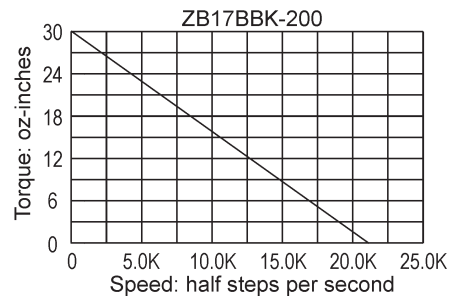
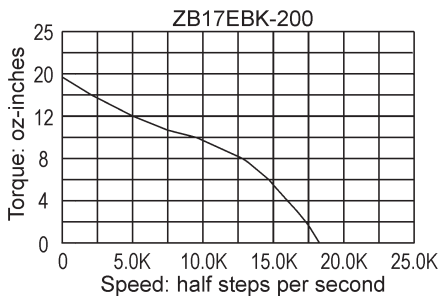
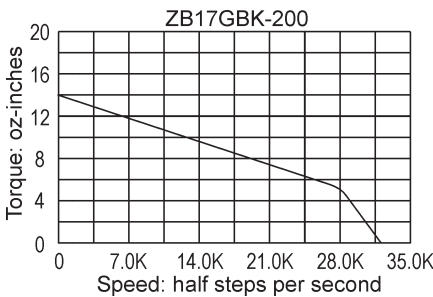

Solutions in motion

