

# Current Sensor: ACS754xCB-050

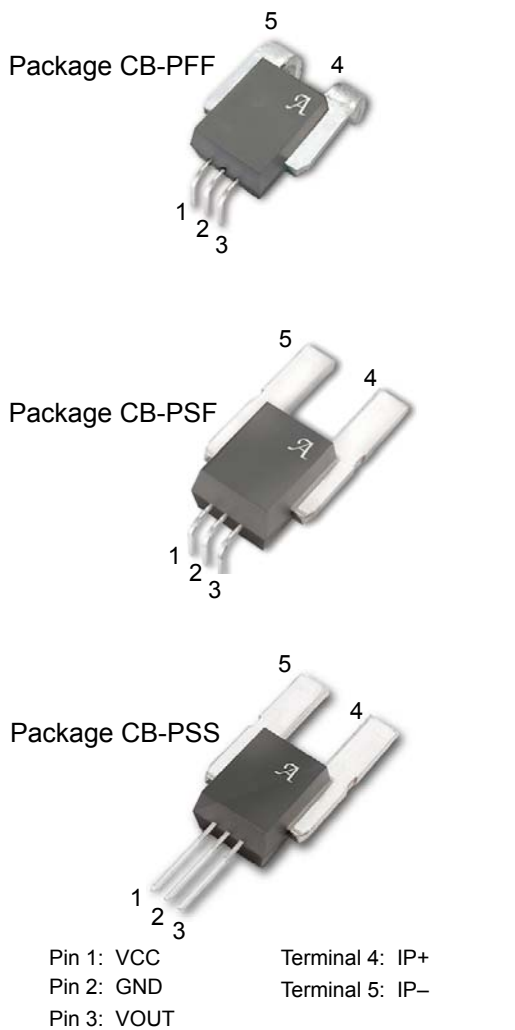

## ABSOLUTE MAXIMUM RATINGS

Supply Voltage, $V_{CC}$ .....	16 V
Reverse Supply Voltage, $V_{RCC}$ .....	-16 V
Output Voltage, $V_{OUT}$ .....	16 V
Reverse Output Voltage, $V_{ROUT}$ .....	-0.1 V
Output Current Source, $I_{OUT(SOURCE)}$ .....	3 mA
Output Current Sink, $I_{OUT(SINK)}$ .....	10 mA
Operating Temperature,	
Ambient, $T_A$ , L range .....	-40 to 150°C
Ambient, $T_A$ , S range .....	-20 to 85°C
Maximum Junction, $T_{J(max)}$ .....	165°C
Maximum Storage Temperature, $T_S$ .....	-65 to 170°C

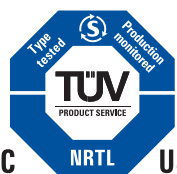

TÜV America  
Certificate Number:  
U8V 04 11 54214 001



The Allegro ACS75x family of current sensors provides economical and precise solutions for current sensing in industrial, automotive, commercial, and communications systems. The device package allows for easy implementation by the customer. Typical applications include motor control, load detection and management, power supplies, and overcurrent fault protection.

The device consists of a precision, low-offset linear Hall sensor circuit with a copper conduction path located near the die. Applied current flowing through this copper conduction path generates a magnetic field which is sensed by the integrated Hall IC and converted into a proportional voltage. Device accuracy is optimized through the close proximity of the magnetic signal to the Hall transducer. A precise, proportional voltage is provided by the low-offset, chopper-stabilized BiCMOS Hall IC, which is programmed for accuracy at the factory.

The output of the device has a positive slope ( $>V_{CC}/2$ ) when an increasing current flows through the primary copper conduction path (from terminal 4 to terminal 5), which is the path used for current sensing. The internal resistance of this conductive path is typically 100  $\mu\Omega$ , providing low power loss. The thickness of the copper conductor allows survival of the device at up to 5 $\times$  overcurrent conditions. The terminals of the conductive path are electrically isolated from the sensor leads (pins 1 through 3). This allows the ACS75x family of sensors to be used in applications requiring electrical isolation without the use of opto-isolators or other costly isolation techniques.

The device is fully calibrated prior to shipment from the factory. The ACS75x family is lead-free. All leads are coated with 100% matte tin, and there is no lead inside the package. The heavy gauge leadframe is made of oxygen-free copper.

## Features and Benefits

- Monolithic Hall IC for high reliability
- Single +5 V supply
- 3 kV<sub>RMS</sub> isolation voltage between terminals 4/5 and pins 1/2/3
- 35 kHz bandwidth
- Automotive temperature range
- End-of-line factory-trimmed for gain and offset
- Ultra-low power loss: 100  $\mu\Omega$  internal conductor resistance
- Ratiometric output from supply voltage
- Extremely stable output offset voltage
- Small package size, with easy mounting capability
- Output proportional to ac and dc currents

## Applications

- Automotive systems
- Industrial systems
- Motor control
- Servo systems
- Power conversion
- Battery monitors

Use the following complete part numbers when ordering:

Part Number	Signal Pins	Terminals	Ambient
ACS754LCB-050-PFF	Formed	Formed	-40 to 150°C
ACS754LCB-050-PSF	Formed	Straight	
ACS754LCB-050-PSS	Straight	Straight	
ACS754SCB-050-PFF	Formed	Formed	-20 to 85°C
ACS754SCB-050-PSF	Formed	Straight	
ACS754SCB-050-PSS	Straight	Straight	

# Current Sensor: ACS754xCB-050

## Functional Block Diagram

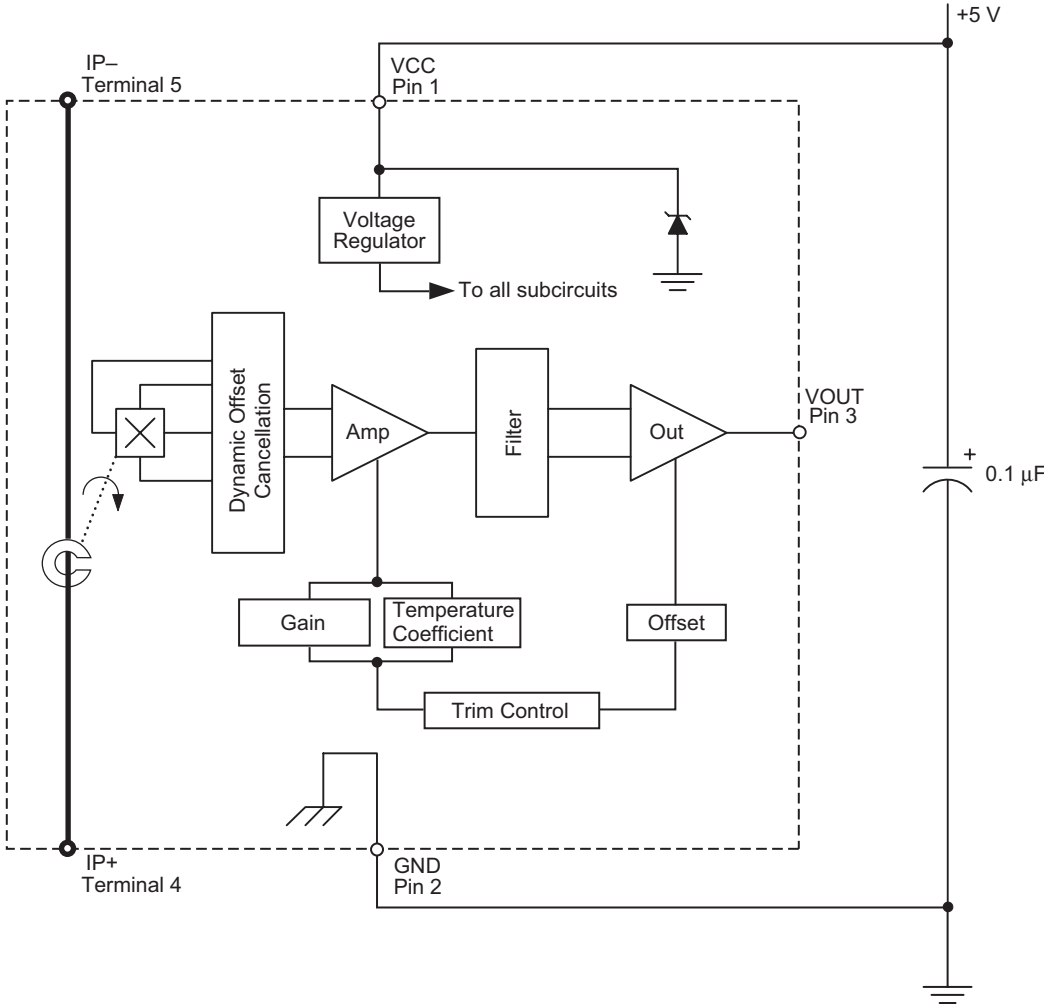

# Current Sensor: ACS754xCB-050

## ELECTRICAL CHARACTERISTICS, over operating ambient temperature range unless otherwise stated

Characteristic	Symbol	Test Conditions	Min.	Typ.	Max.	Units
Primary Sensed Current	$I_P$		-50	-	50	A
Supply Voltage	$V_{CC}$		4.5	5.0	5.5	V
Supply Current	$I_{CC}$	$V_{CC} = 5.0$ V, output open	6.5	8	10	mA
Output Resistance	$R_{OUT}$	$I_{OUT} = 1.2$ mA	-	1	2	$\Omega$
Output Capacitance Load	$C_{LOAD}$	VOUT to GND	-	-	10	nF
Output Resistive Load	$R_{LOAD}$	VOUT to GND	4.7	-	-	k $\Omega$
Primary Conductor Resistance	$R_{PRIMARY}$	$I_P = \pm 100$ A; $T_A = 25^\circ$ C	-	100	-	$\mu\Omega$
		Pins 1-3 and 4-5; 60 Hz, 1 minute	3.0	-	-	kV

## PERFORMANCE CHARACTERISTICS, -20°C to +85°C, $V_{CC} = 5$ V unless otherwise specified

Propagation time	$t_{PROP}$	$I_P = \pm 50$ A, $T_A = 25^\circ$ C	-	4	-	$\mu$ s
Response time	$t_{RESPONSE}$	$I_P = \pm 50$ A, $T_A = 25^\circ$ C	-	12	-	$\mu$ s
Rise time	$t_r$	$I_P = \pm 50$ A, $T_A = 25^\circ$ C	-	11	-	$\mu$ s
Frequency Bandwidth	f	-3 dB, $T_A = 25^\circ$ C	-	35	-	kHz
Sensitivity	Sens	Over full range of $I_P$ , $T_A = 25^\circ$ C	-	40	-	mV/A
		Over full range of $I_P$	37.8	-	42.0	mV/A
Noise	$V_{NOISE}$	Peak-to-peak, $T_A = 25^\circ$ C, no external filter	-	65	-	mV
Nonlinearity	$E_{LIN}$	Over full range of $I_P$	-	-	$\pm 1.5$	%
Symmetry	$E_{SYM}$	Over full range of $I_P$	98	100	102	%
Zero Current Output Voltage	$V_{OUT(Q)}$	$I = 0$ A, $T_A = 25^\circ$ C	-	$V_{CC}/2$	-	V
Electrical Offset Voltage (Magnetic error not included)	$V_{OE}$	$I = 0$ A, $T_A = 25^\circ$ C	-10	-	10	mV
		$I = 0$ A	-20	-	20	mV
Magnetic Offset Error	$I_{ERROM}$	$I = 0$ A, after excursion of 100 A	-	$\pm 0.1$	$\pm 0.30$	A
Total Output Error (Including all offsets)	$E_{TOT}$	Over full range of $I_P$ , $T_A = 25^\circ$ C	-	$\pm 1.0$	-	%
		Over full range of $I_P$	-	-	$\pm 5.0$	%

## PERFORMANCE CHARACTERISTICS, -40°C to +150°C, $V_{CC} = 5$ V unless otherwise specified

Propagation time	$t_{PROP}$	$I_P = \pm 50$ A, $T_A = 25^\circ$ C	-	4	-	$\mu$ s
Response time	$t_{RESPONSE}$	$I_P = \pm 50$ A, $T_A = 25^\circ$ C	-	12	-	$\mu$ s
Rise time	$t_r$	$I_P = \pm 50$ A, $T_A = 25^\circ$ C	-	11	-	$\mu$ s
Frequency Bandwidth	f	-3 dB, $T_A = 25^\circ$ C	-	35	-	kHz
Sensitivity	Sens	Over full range of $I_P$ , $T_A = 25^\circ$ C	-	40	-	mV/A
		Over full range of $I_P$	36.0	-	42.8	mV/A
Noise	$V_{NOISE}$	Peak-to-peak, $T_A = 25^\circ$ C, no external filter	-	65	-	mV
Nonlinearity	$E_{LIN}$	Over full range of $I_P$	-	-	$\pm 1.8$	%
Symmetry	$E_{SYM}$	Over full range of $I_P$	98	100	102	%
Zero Current Output Voltage	$V_{OUT(Q)}$	$I = 0$ A, $T_A = 25^\circ$ C	-	$V_{CC}/2$	-	V
Electrical Offset Voltage (Magnetic error not included)	$V_{OE}$	$I = 0$ A, $T_A = 25^\circ$ C	-10	-	10	mV
		$I = 0$ A	-35	-	35	mV
Magnetic Offset Error	$I_{ERROM}$	$I = 0$ A, after excursion of 100 A	-	$\pm 0.1$	$\pm 0.40$	A
Total Output Error (Including all offsets)	$E_{TOT}$	Over full range of $I_P$ , $T_A = 25^\circ$ C	-	$\pm 1.0$	-	%
		Over full range of $I_P$	-	-	$\pm 9.9$	%

# Current Sensor: ACS754xCB-050

## Definitions of Accuracy Characteristics

**Sensitivity (Sens):** The change in sensor output in response to a 1 A change through the primary conductor. The sensitivity is the product of the magnetic circuit sensitivity (G/A) and the linear IC amplifier gain (mV/G). The linear IC amplifier gain is trimmed at the factory to optimize the sensitivity (mV/A) for the full-scale current of the device.

**Noise ( $V_{\text{NOISE}}$ ):** The product of the linear IC amplifier gain (mV/G) and the noise floor for the Allegro Hall effect linear IC ( $\approx 1$  G). The noise floor is derived from the thermal and shot noise observed in Hall elements. Dividing the noise (mV) by the sensitivity (mV/A) provides the smallest current that the device is able to resolve.

**Linearity ( $E_{\text{LIN}}$ ):** The degree to which the voltage output from the sensor varies in direct proportion to the primary current through its full-scale amplitude. Linearity reveals the maximum deviation from the ideal transfer curve for this transducer. Nonlinearity in the output can be attributed to the gain variation across temperature and saturation of the flux concentrator approaching the full-scale current. The following equation is used to derive the linearity:

$$100 \left\{ 1 - \left[ \frac{\Delta \text{ gain} \times \% \text{ sat} (V_{\text{out\_full-scale amperes}} - V_{\text{OUT(Q)}})}{2 (V_{\text{out\_half-scale amperes}} - V_{\text{OUT(Q)}})} \right] \right\}$$

where

$\Delta$  gain = the gain variation as a function of temperature changes from 25°C,

% sat = the percentage of saturation of the flux concentrator, which becomes significant as the current being sensed approaches full-scale  $\pm I_p$ , and

$V_{\text{out\_full-scale amperes}}$  = the output voltage (V) when the sensed current approximates full-scale  $\pm I_p$ .

**Symmetry ( $E_{\text{SYM}}$ ):** The degree to which the absolute voltage output from the sensor varies in proportion to either a positive or negative full-scale primary current. The following equation is used to derive symmetry:

$$100 \left[ \frac{V_{\text{out\_+full-scale amperes}} - V_{\text{OUT(Q)}}}{V_{\text{OUT(Q)}} - V_{\text{out\_full-scale amperes}}} \right]$$

**Quiescent output voltage ( $V_{\text{OUT(Q)}}$ ):** The output of the sensor when the primary current is zero. For a unipolar supply voltage, it nominally remains at  $V_{\text{CC}}/2$ . Thus,  $V_{\text{CC}} = 5$  V translates into  $V_{\text{OUT(Q)}} = 2.5$  V. Variation in  $V_{\text{OUT(Q)}}$  can be attributed to the resolution of the Allegro linear IC quiescent voltage trim, magnetic hysteresis, and thermal drift.

**Electrical offset voltage ( $V_{\text{OE}}$ ):** The deviation of the device output from its ideal quiescent value of  $V_{\text{CC}}/2$  due to nonmagnetic causes.

**Magnetic offset error ( $I_{\text{ERROM}}$ ):** The magnetic offset is due to the residual magnetism (remnant field) of the core material. The magnetic offset error is highest when the magnetic circuit has been saturated, usually when the device has been subjected to a full-scale or high-current overload condition. The magnetic offset is largely dependent on the material used as a flux concentrator. The larger magnetic offsets are observed at the lower operating temperatures.

**Accuracy ( $E_{\text{TOT}}$ ):** The accuracy represents the maximum deviation of the actual output from its ideal value. This is also known as the total output error. The accuracy is illustrated graphically in the Output Voltage versus Current chart on the following page.

Accuracy is divided into four areas:

- **0 A at 25°C:** Accuracy of sensing zero current flow at 25°C, without the effects of temperature.
- **0 A over temperature:** Accuracy of sensing zero current flow including temperature effects.
- **Full-scale current at 25°C:** Accuracy of sensing the full-scale current at 25°C, without the effects of temperature.
- **Full-scale current over  $\Delta$  temperature:** Accuracy of sensing full-scale current flow including temperature effects.

# Current Sensor: ACS754xCB-050

Output voltage vs. current, illustrating sensor accuracy at 0 A and at full-scale current

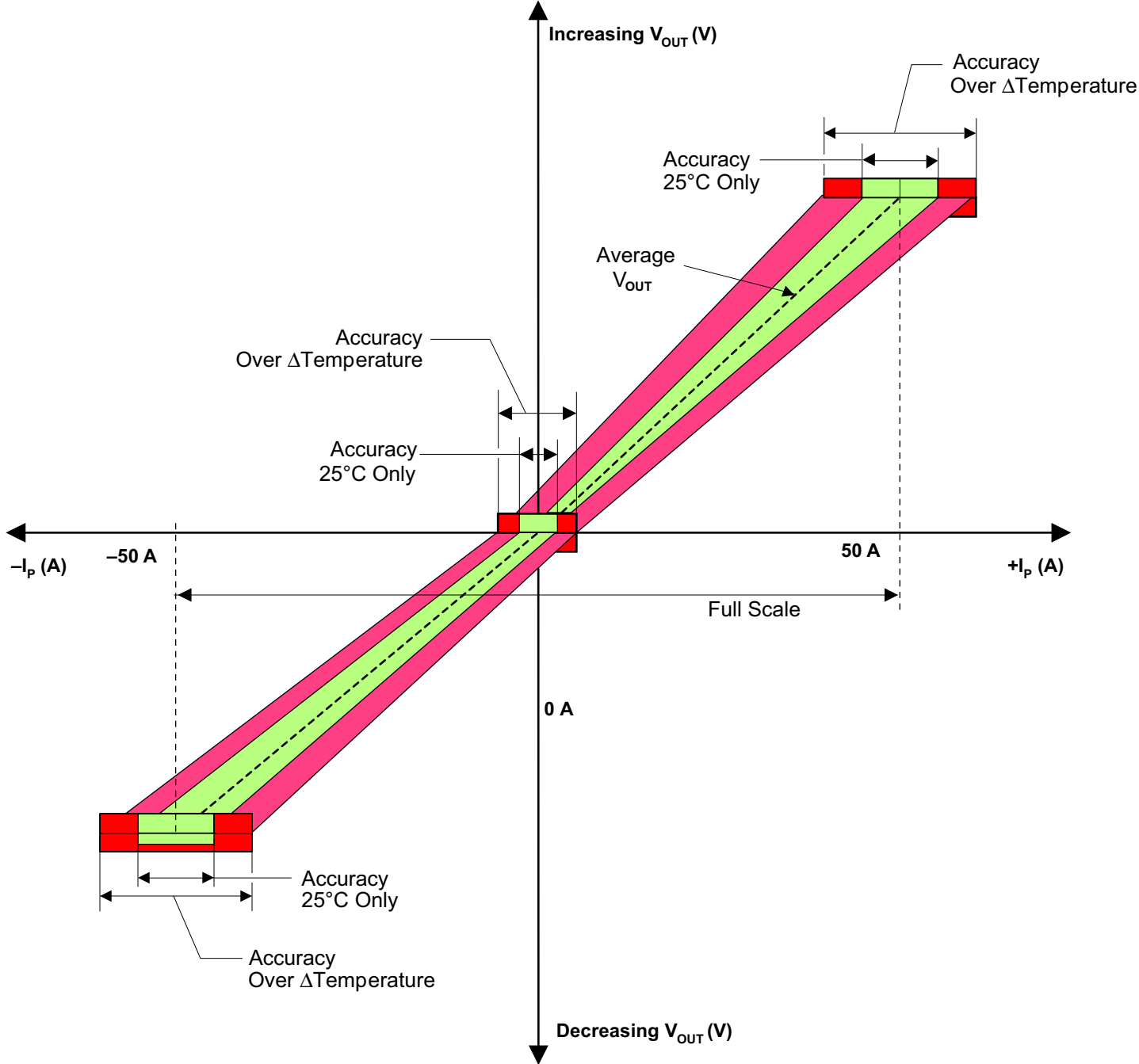

# Current Sensor: ACS754xCB-050

## Definitions of Dynamic Response Characteristics

**Propagation delay ( $t_{PROP}$ ):** The time required for the sensor output to reflect a change in the primary current signal. Propagation delay is attributed to inductive loading within the linear IC package, as well as in the inductive loop formed by the primary conductor geometry. Propagation delay can be considered as a fixed time offset and may be compensated.

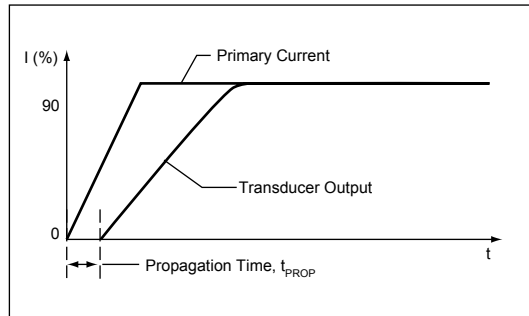

**Response time ( $t_{RESPONSE}$ ):** The time interval between a) when the primary current signal reaches 90% of its final value, and b) when the sensor reaches 90% of its output corresponding to the applied current.

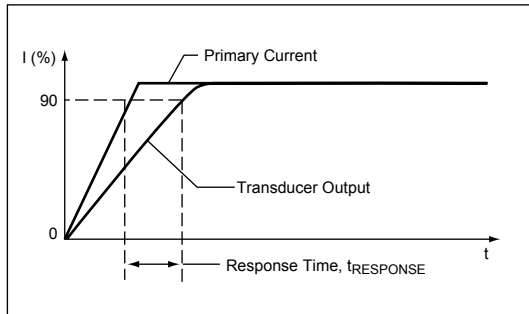

**Rise time ( $t_r$ ):** The time interval between a) when the sensor reaches 10% of its full scale value, and b) when it reaches 90% of its full scale value. The rise time to a step response is used to derive the bandwidth of the current sensor, in which  $f(-3 \text{ dB}) = 0.35 / t_r$ . Both  $t_r$  and  $t_{RESPONSE}$  are detrimentally affected by eddy current losses observed in the conductive IC ground plane and, to varying degrees, in the ferrous flux concentrator within the current sensor package.

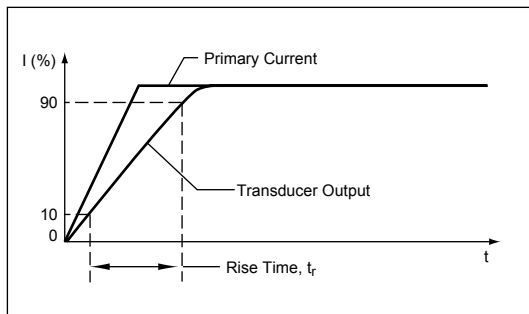

# Current Sensor: ACS754xCB-050

### Standards and Physical Specifications

Parameter	Specification
Flammability (package molding compound)	UL recognized to UL 94V-0
Fire and Electric Shock	UL60950-1:2003 EN60950-1:2001 CAN/CSA C22.2 No. 60950-1:2003
Creepage distance, current terminals to sensor pins	7.25 mm
Clearance distance, current terminals to sensor pins	7.25 mm
Package mass	4.63 g typical

Step Response,  $I_p = 0$  to 50 A, no external filter

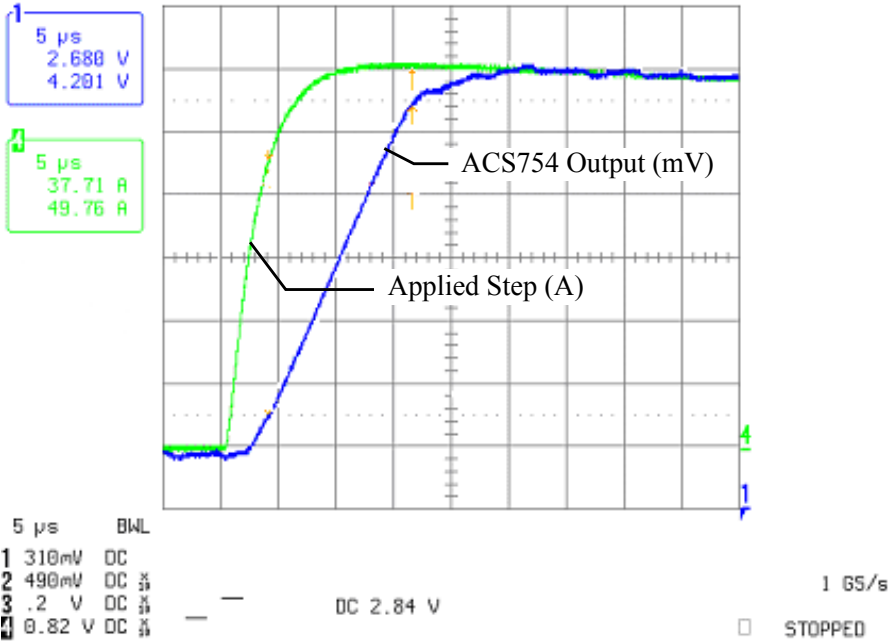

# Current Sensor: ACS754xCB-050

## Device Branding Key (Two alternative styles are used)

ACS754 TCB050 YYWWA	ACS	Allegro Current Sensor
	754	Device family number
	<i>T</i>	Operating ambient temperature range code [L or S]
	CB	Package type designator
	050	Maximum measurable current
	<i>YY</i>	Manufacturing date code: Calendar year (last two digits)
	<i>WW</i>	Manufacturing date code: Calendar week
ACS754 TCB050 <i>L...L</i> YYWW	ACS	Allegro Current Sensor
	754	Device family number
	<i>T</i>	Operating ambient temperature range code [L or S]
	CB	Package type designator
	050	Maximum measurable current
	<i>L...L</i>	Manufacturing lot code
	<i>YY</i>	Manufacturing date code: Calendar year (last two digits)
<i>WW</i>	Manufacturing date code: Calendar week	



# Current Sensor: ACS754xCB-050

## Package CB-PFF

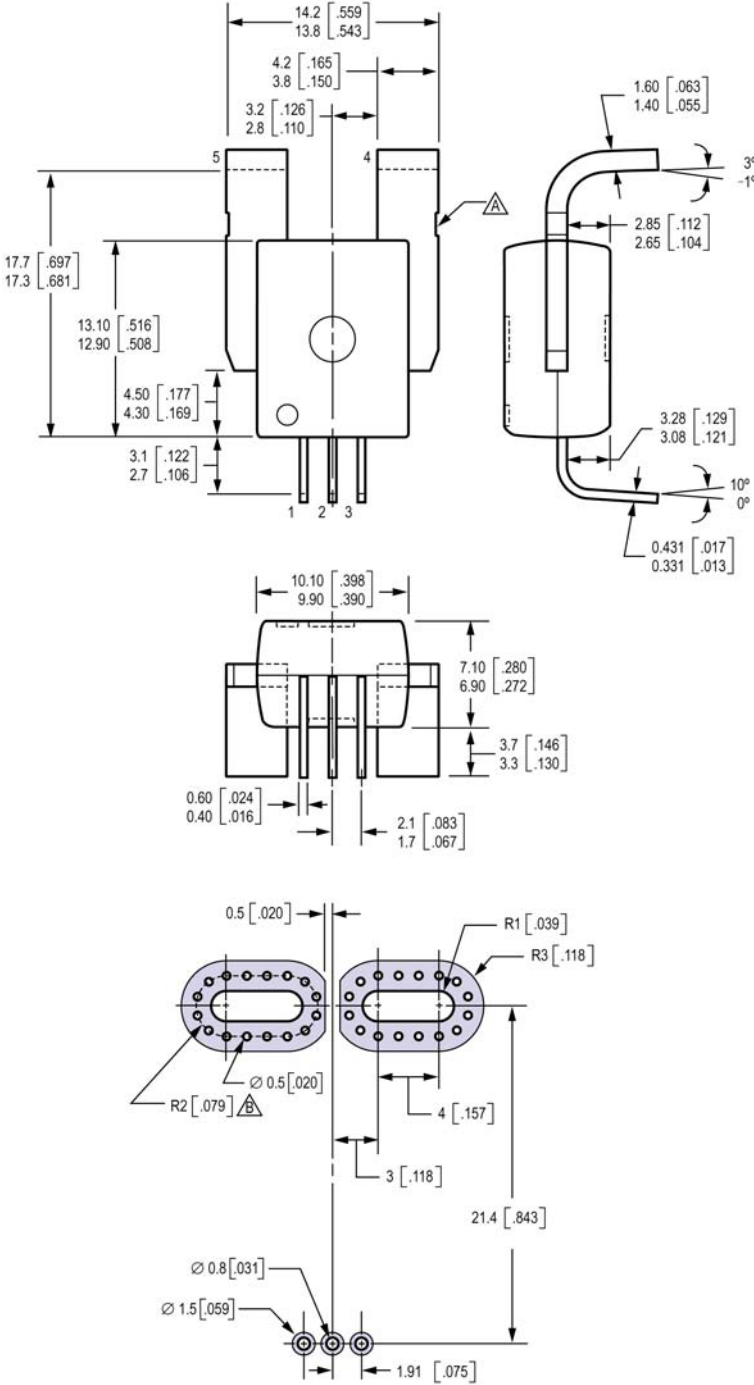

Dimensions in millimeters  
 U.S. Customary dimensions (in.) in brackets, for reference only  
 ▲ Dambar removal intrusion  
 ▲ Perimeter through-holes recommended

# Current Sensor: ACS754xCB-050

## Package CB-PSF

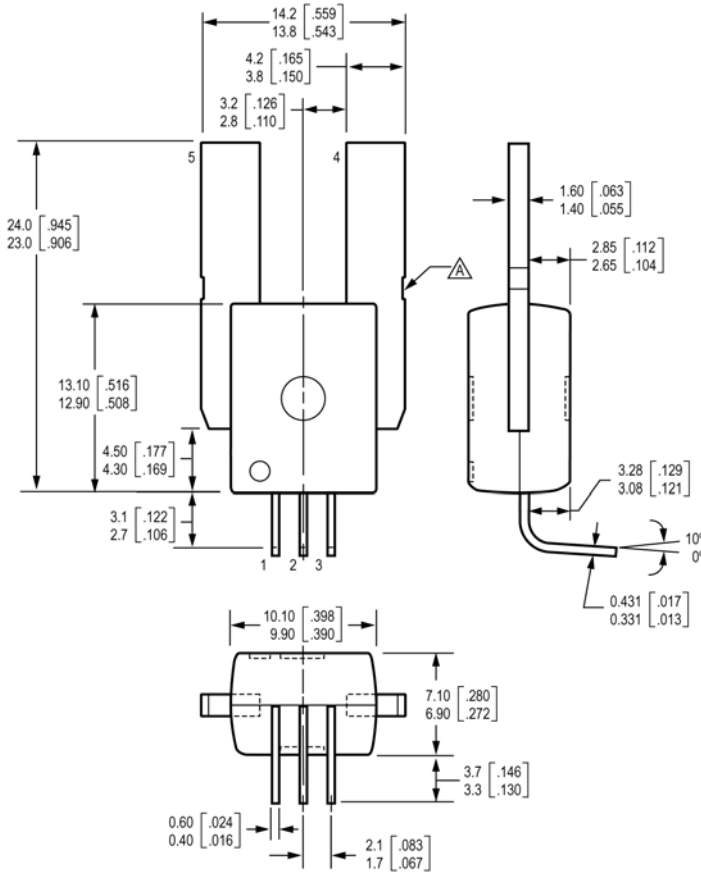

Dimensions in millimeters  
U.S. Customary dimensions (in.) in brackets, for reference only  
▲ Dambar removal intrusion

## Package CB-PSS

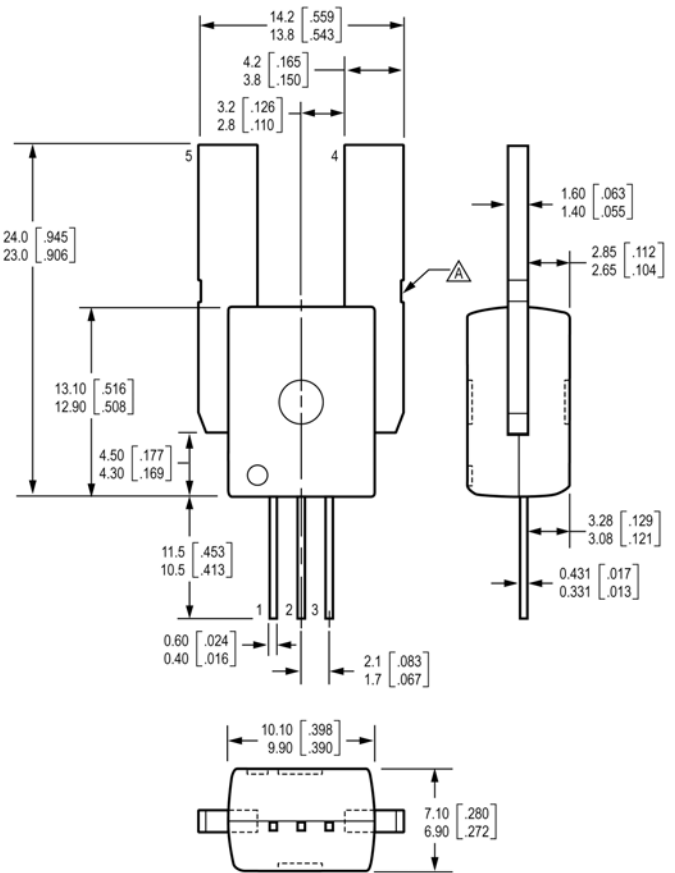

Dimensions in millimeters  
U.S. Customary dimensions (in.) in brackets, for reference only  
▲ Dambar removal intrusion

The products described herein are manufactured under one or more of the following U.S. patents: 5,045,920; 5,264,783; 5,442,283; 5,389,889; 5,581,179; 5,517,112; 5,619,137; 5,621,319; 5,650,719; 5,686,894; 5,694,038; 5,729,130; 5,917,320; and other patents pending.

Allegro MicroSystems, Inc. reserves the right to make, from time to time, such departures from the detail specifications as may be required to permit improvements in the performance, reliability, or manufacturability of its products. Before placing an order, the user is cautioned to verify that the information being relied upon is current.

Allegro products are not authorized for use as critical components in life-support devices or systems without express written approval.

The information included herein is believed to be accurate and reliable. However, Allegro MicroSystems, Inc. assumes no responsibility for its use; nor for any infringement of patents or other rights of third parties which may result from its use.

Copyright © 2004, 2005, AllegroMicrosystems, Inc.