

## N-channel TO-220F/I-PAKN/D-PAK MOSFET

### Features

- High ruggedness
- $R_{DS(ON)}$  (Max  $2.2\Omega$ )@ $V_{GS}=10V$
- Gate Charge (Typ 18nC)
- Improved dv/dt Capability
- 100% Avalanche Tested

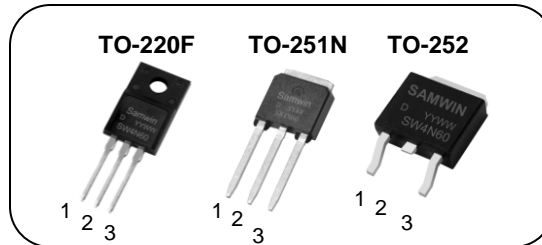

1. Gate 2. Drain 3. Source

$BV_{DSS} : 600V$

$I_D : 4A$

$R_{DS(ON)} : 2.2\Omega$

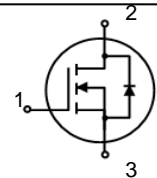

### General Description

This power MOSFET is produced with advanced VDMOS technology of SAMWIN. This technology enable power MOSFET to have better characteristics, such as fast switching time, low on resistance, low gate charge and especially excellent avalanche characteristics. This power MOSFET is usually used at high efficient DC to DC converter block and switch mode power supply.

### Order Codes

Item	Sales Type	Marking	Package	Packaging
1	SW F 4N60	SW4N60D	TO-220F	TUBE
2	SW I 4N60	SW4N60D	TO-251N	TUBE
3	SW D 4N60	SW4N60D	TO-252	REEL

### Absolute maximum ratings

Symbol	Parameter	Value			Unit
		TO-220F	TO-251N	TO-252	
$V_{DSS}$	Drain to Source Voltage	600			V
$I_D$	Continuous Drain Current (@ $T_C=25^\circ C$ )	4*			A
	Continuous Drain Current (@ $T_C=100^\circ C$ )	2.5*			A
$I_{DM}$	Drain current pulsed (note 1)	16			A
$V_{GS}$	Gate to Source Voltage	$\pm 30$			V
$E_{AS}$	Single pulsed Avalanche Energy (note 2)	184			mJ
$E_{AR}$	Repetitive Avalanche Energy (note 1)	55			mJ
dv/dt	Peak diode Recovery dv/dt (note 3)	5			V/ns
$P_D$	Total power dissipation (@ $T_C=25^\circ C$ )	23.5	152.6	141.0	W
	Derating Factor above 25°C	0.19	1.22	1.13	W/°C
$T_{STG}, T_J$	Operating Junction Temperature & Storage Temperature	-55 ~ + 150			°C
$T_L$	Maximum Lead Temperature for soldering purpose, 1/8 from Case for 5 seconds.	300			°C

\*. Drain current is limited by junction temperature.

### Thermal characteristics

Symbol	Parameter	Value			Unit
		TO-220F	TO-251N	TO-252	
$R_{thjc}$	Thermal resistance, Junction to case	5.31	0.82	0.89	°C/W
$R_{thcs}$	Thermal resistance, Case to Sink				°C/W
$R_{thja}$	Thermal resistance, Junction to ambient	47.1	83.5	79.0	°C/W

### Electrical characteristic ( $T_C = 25^\circ\text{C}$ unless otherwise specified )

Symbol	Parameter	Test conditions	Min.	Typ.	Max.	Unit
<b>Off characteristics</b>						
$BV_{DSS}$	Drain to source breakdown voltage	$V_{GS}=0V, I_D=250\mu A$	600			V
$\Delta BV_{DSS} / \Delta T_J$	Breakdown voltage temperature coefficient	$I_D=250\mu A$ , referenced to $25^\circ\text{C}$		0.47		V/ $^\circ\text{C}$
$I_{DSS}$	Drain to source leakage current	$V_{DS}=600V, V_{GS}=0V$			1	$\mu A$
		$V_{DS}=480V, T_C=125^\circ\text{C}$			50	$\mu A$
$I_{GSS}$	Gate to source leakage current, forward	$V_{GS}=30V, V_{DS}=0V$			100	nA
	Gate to source leakage current, reverse	$V_{GS}=-30V, V_{DS}=0V$			-100	nA
<b>On characteristics</b>						
$V_{GS(TH)}$	Gate threshold voltage	$V_{DS}=V_{GS}, I_D=250\mu A$	2.5		4.5	V
$R_{DS(ON)}$	Drain to source on state resistance	$V_{GS}=10V, I_D = 2A$		1.9	2.2	$\Omega$
$G_{fs}$	Forward Transconductance	$V_{DS} = 30 V, I_D = 2 A$	3.5			S
<b>Dynamic characteristics</b>						
$C_{iss}$	Input capacitance	$V_{GS}=0V, V_{DS}=25V, f=1\text{MHz}$		522		pF
$C_{oss}$	Output capacitance			57		
$C_{rss}$	Reverse transfer capacitance			49		
$t_{d(on)}$	Turn on delay time	$V_{DS}=300V, I_D=4A, R_G=25\Omega$ (note 4,5)		10		ns
$t_r$	Rising time			25		
$t_{d(off)}$	Turn off delay time			37		
$t_f$	Fall time			25		
$Q_g$	Total gate charge	$V_{DS}=480V, V_{GS}=10V, I_D=4A$ (note 4,5)		18		nC
$Q_{gs}$	Gate-source charge			3		
$Q_{gd}$	Gate-drain charge			9		

### Source to drain diode ratings characteristics

Symbol	Parameter	Test conditions	Min.	Typ.	Max.	Unit
$I_S$	Continuous source current	Integral reverse p-n Junction diode in the MOSFET			4	A
$I_{SM}$	Pulsed source current				16	A
$V_{SD}$	Diode forward voltage drop.	$I_S=4A, V_{GS}=0V$			1.5	V
$T_{rr}$	Reverse recovery time	$I_S=4A, V_{GS}=0V,$ $di_F/dt=100A/\mu s$		233		ns
$Q_{rr}$	Reverse recovery Charge				1.6	$\mu C$

#### ※. Notes

1. Repetitive rating : pulse width limited by junction temperature.
2.  $L = 22.8\text{mH}, I_{AS} = 4A, V_{DD} = 50V, R_G=25\Omega$ , Starting  $T_J = 25^\circ\text{C}$
3.  $I_{SD} \leq 4A, di/dt = 100A/\mu s, V_{DD} \leq BV_{DSS}$ , Starting  $T_J = 25^\circ\text{C}$
4. Pulse Test : Pulse Width  $\leq 300\mu s$ , duty cycle  $\leq 2\%$ .
5. Essentially independent of operating temperature.

**Fig. 1. On-state characteristics**

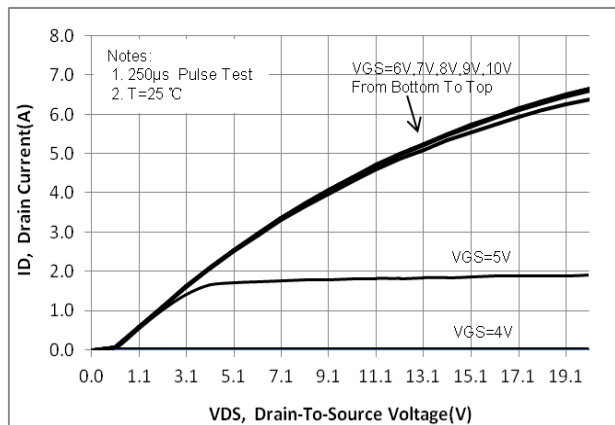

**Fig. 2. On-resistance variation vs. drain current and gate voltage**

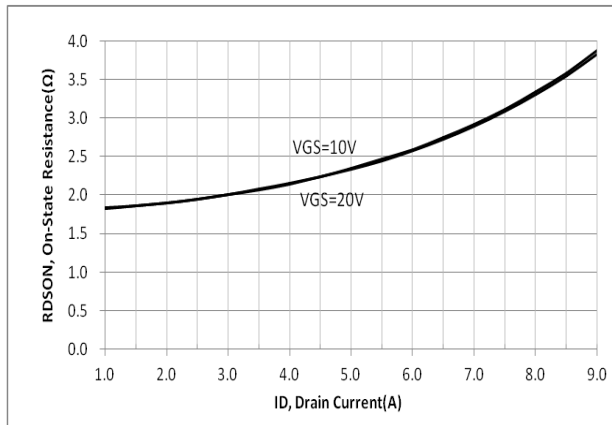

**Fig. 3. Gate charge characteristics**

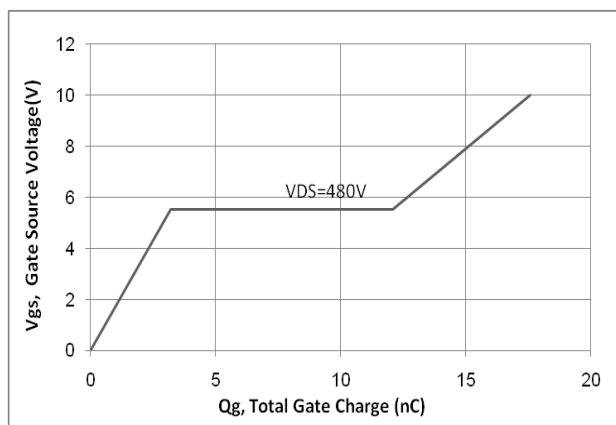

**Fig. 4. On state current vs. diode forward voltage**

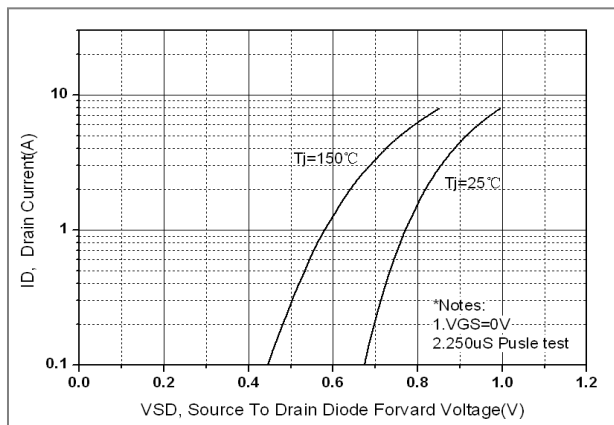

**Fig 5. Breakdown Voltage Variation vs. Junction Temperature**

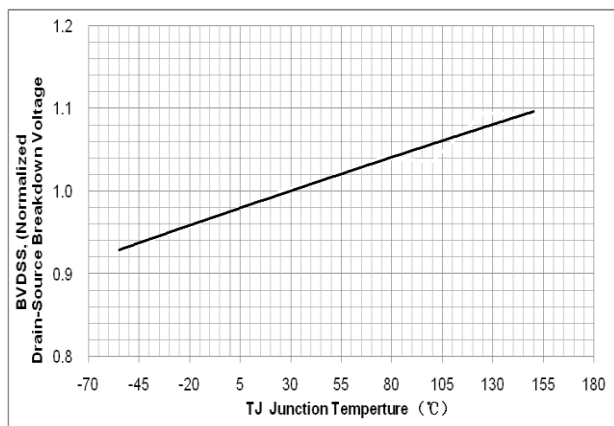

**Fig. 6. On resistance variation vs. junction temperature**

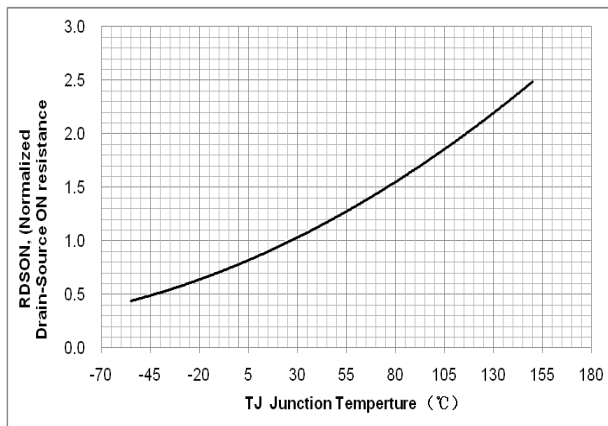

**Fig. 7. Maximum safe operating area (TO-220F)**

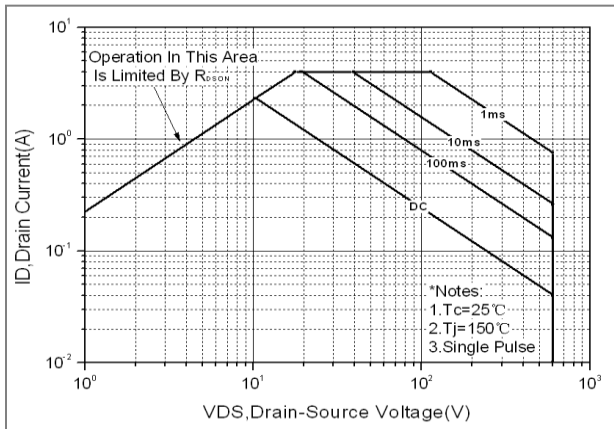

**Fig. 8. Transient thermal response curve (TO-220F)**

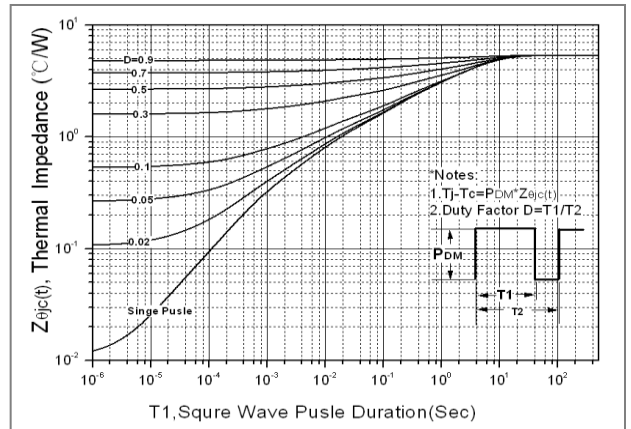

**Fig. 9. Maximum safe operating area (TO-251N)**

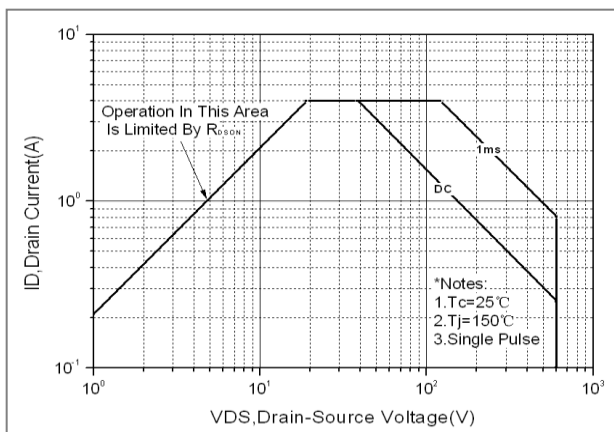

**Fig. 10. Transient thermal response curve (TO-251N)**

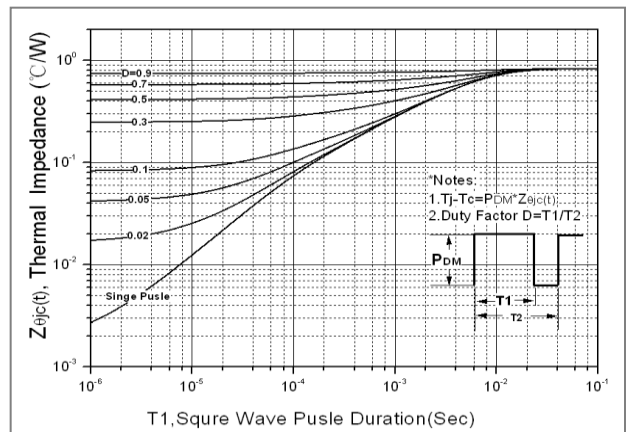

**Fig. 11. Maximum safe operating area (TO-252)**

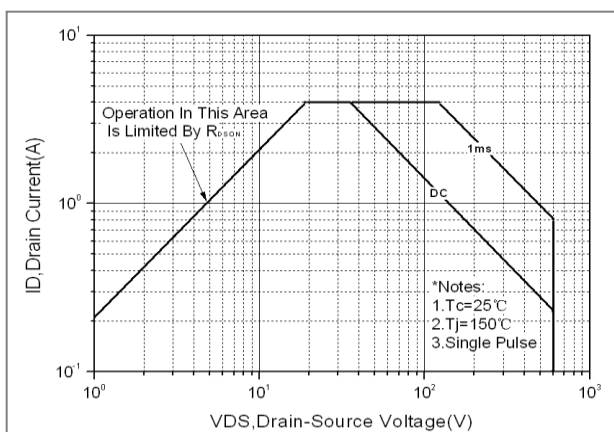

**Fig. 12. Transient thermal response curve (TO-252)**

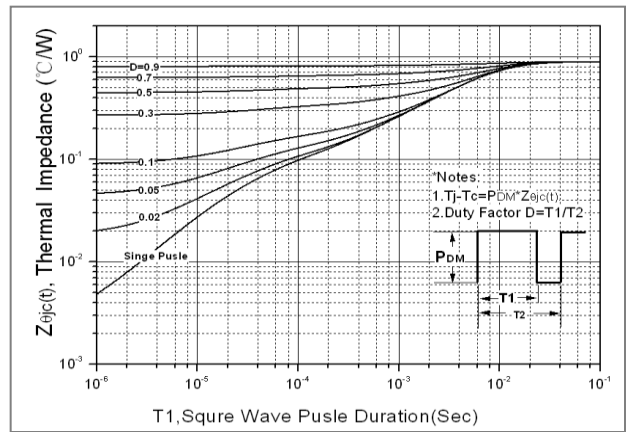

**Fig. 13. Capacitance Characteristics**

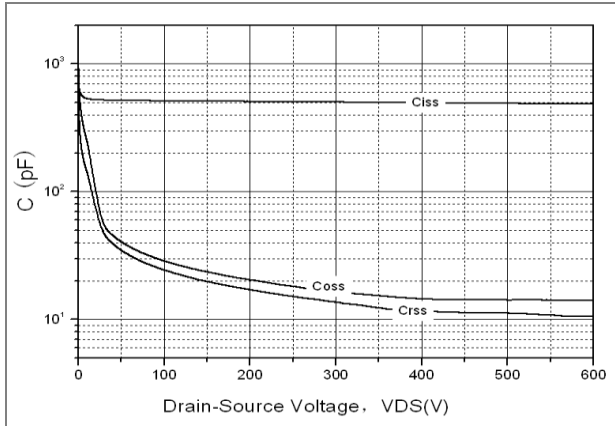

**Fig. 14. Gate charge test circuit & waveform**

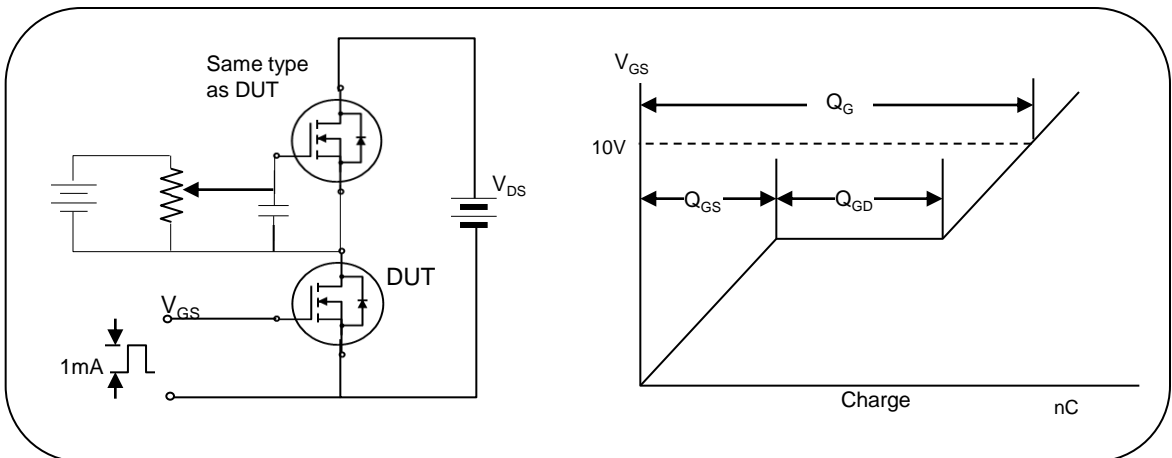

**Fig. 15. Switching time test circuit & waveform**

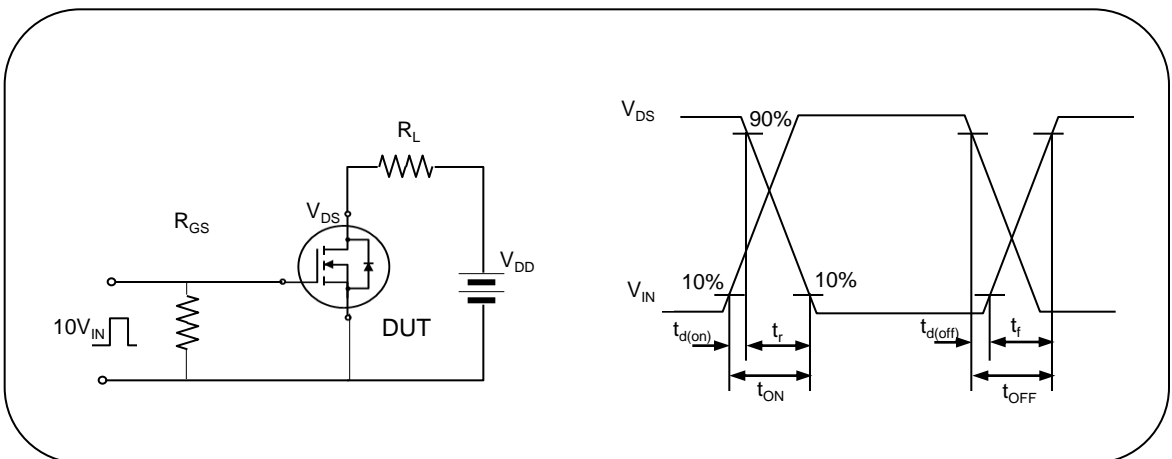

**Fig. 16. Unclamped Inductive switching test circuit & waveform**

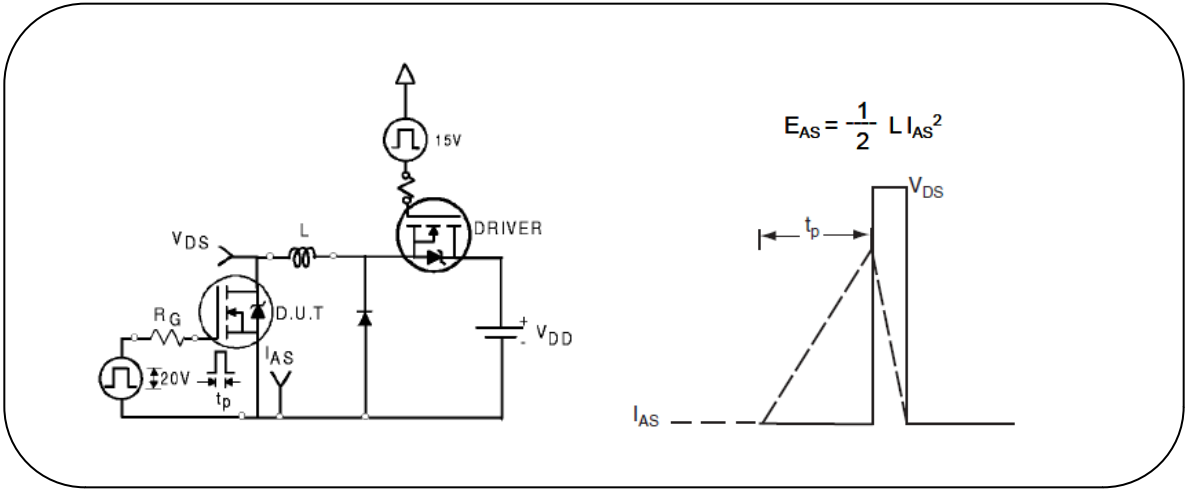

**Fig. 17. Peak diode recovery dv/dt test circuit & waveform**

