



Copyright FCI



FCIconnect.com



APP:U

PART NUMBER
10118194-0001LF

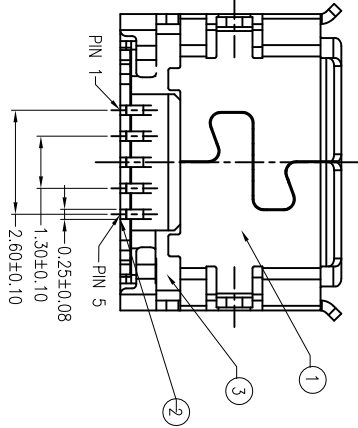
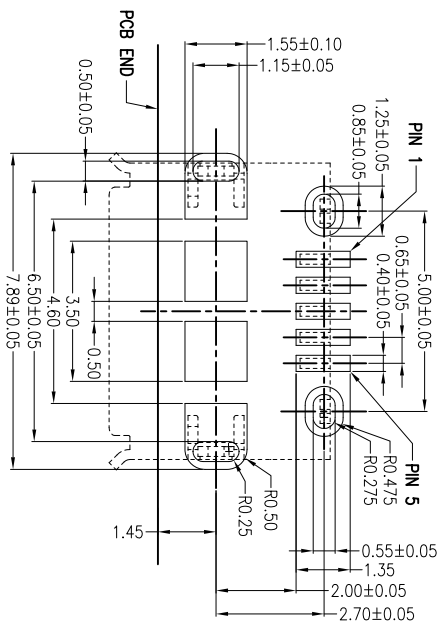
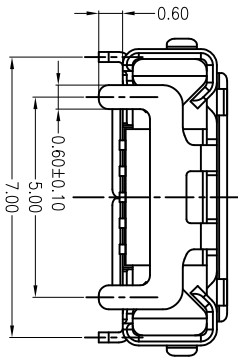
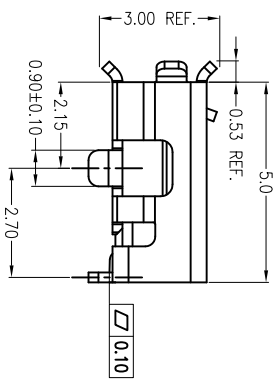
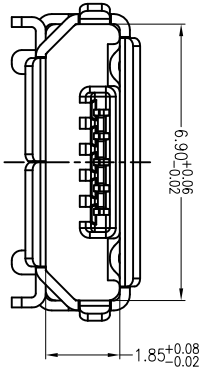
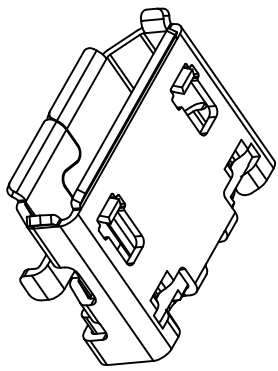
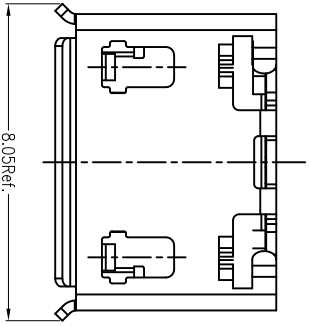

| Item | Title | QTY |
|------|----------------|-----|
| 1 | Shell | 1 |
| 2 | Terminal | 5 |
| 3 | Insert/Molding | 1 |

| mat'l. code | surf. code | tolerance | projection | product family | USB |
|-------------|------------|------------|------------|-----------------------------|-----------|
| ASME Y14.5 | ASME Y14.5 | ASME Y14.5 | ASME Y14.5 | MICRO USB B TYPE RECEPTACLE | |
| ltf | ecm no | dr | date | engr | chr |
| A | LS | 10/21/11 | | JASON HSU | JASON HSU |
| | | angles | g | scale | |
| | | X°Z° | .XXX±0.10 | MM | |
| | | dr | JASON HSU | dwg no | |
| | | engr | JASON HSU | 10118194 | |
| | | chr | JASON HSU | sheet 1 of 1 | |
| | | appd | GARY HSIEH | size | |
| | | revision | A | A4 | |
| | | sheet | 1 | CUSTOMER Drawing | |
| | | index | | | |

- NOTES:
1. MATERIAL:
HOUSING: HIGH THERMOPLASTIC RESIN, UL94V-0, COLOR: BLACK
TERMINAL: COPPER ALLOY
SHELL: STAINLESS
 2. FINISH:
CONTACT AREA: GOLD PLATED
CONTACT SOLDER AREA: GOLD FLASH
SHELL: MATTE TIN PLATED
UNDER NICKEL PLATED ALL OVER.
 3. PRODUCT SPECIFICATION: GS-12-641.
 4. PACKAGING SPECIFICATION: GS-14-2180.
 5. THE "LF" MEANS FOR LEAD FREE AND CAN WITHSTAND EXPOSE TO 260°C PEAK TEMPERATURE FOR 10 SECONDS IN IR REFLOW PROCESS.

form: AdmmXlc 1 2 3 4 5 B A A B