

Type MC, Surface-Mount Mica Chip Capacitors

High-Frequency, High-Stability Chip for Instruments and RF

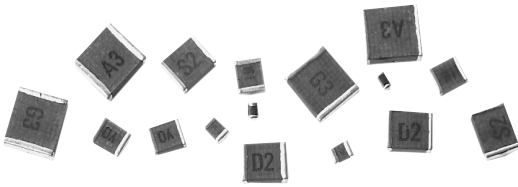

With self-resonant frequencies typically above one gigahertz for popular RF capacitance values and with a Q above 2,000, Type MC capacitors are the answer for high-frequency applications like flight radio and cable television. The natural mica dielectric retains its high-Q to many megahertz, so higher and higher frequency applications are limited by the circuit inductance, not the Type MC capacitor.

Performance Highlights

- Voltages: 100 Vdc, 500 Vdc, and 1000 Vdc
- Capacitance Range: .5 pF to 2,000 pF
- Capacitance Tolerance: $\pm 0.25\%$ to $\pm 5\%$
- Temperature Range: -55°C to $+125^{\circ}\text{C}$
- Low impedance to beyond 1 GHz
- Near-zero capacitance change, all environments
- Available in tight tolerance exact values
- Easy to attach to printed circuit boards
- Case sizes 0805, 1210, 1812, and 2220
- Handles pulses with $dV/dt > 20,000 \text{ V}/\mu\text{s}$
- Withstands 200% rated voltage

Ratings

Cap pF	Catalog Number	Case Type	Cap pF	Catalog Number	Case Type	Cap pF	Catalog Number	Case Type
100 Vdc			100 Vdc			100 Vdc		
1	MC08CA010D	0805	56	MC12FA560J	1210	300	MC18FA301J	1812
2	MC08CA020D	0805	62	MC12FA620J	1210	330	MC18FA331J	1812
3	MC08CA030D	0805	68	MC12FA680J	1210	360	MC18FA361J	1812
4	MC08CA040D	0805	75	MC12FA750J	1210	390	MC18FA391J	1812
5	MC08CA050D	0805	82	MC12FA820J	1210	430	MC18FA431J	1812
6	MC08CA060D	0805	91	MC12FA910J	1210	470	MC18FA471J	1812
7	MC08CA070D	0805	100	MC12FA101J	1210	500	MC18FA501J	1812
8	MC08CA080D	0805	110	MC12FA111J	1210	510	MC18FA511J	1812
9	MC08CA090D	0805	120	MC12FA121J	1210	560	MC18FA561J	1812
10	MC08CA100D	0805	130	MC12FA131J	1210	620	MC18FA621J	1812
12	MC08EA120J	0805	150	MC12FA151J	1210	680	MC18FA681J	1812
15	MC08EA150J	0805	160	MC12FA161J	1210	750	MC18FA751J	1812
18	MC08EA180J	0805	180	MC12FA181J	1210	820	MC18FA821J	1812
20	MC08EA200J	0805	200	MC12FA201J	1210	910	MC22FA911J	2220
22	MC08EA220J	0805	220	MC12FA221J	1210	1000	MC22FA102J	2220
24	MC08EA240J	0805	240	MC12FA241J	1210	1100	MC22FA112J	2220
27	MC08EA270J	0805	250	MC12FA251J	1210	1200	MC22FA122J	2220
30	MC08EA300J	0805	270	MC12FA271J	1210	1500	MC22FA152J	2220
33	MC08FA330J	0805	300	MC12FA301J	1210	1800	MC22FA182J	2220
36	MC08FA360J	0805	330	MC12FA331J	1210	2000	MC22FA202J	2220
39	MC08FA390J	0805	360	MC12FA361J	1210	2220	MC22FA222J	2220
43	MC08FA430J	0805	390	MC12FA391J	1210			
47	MC12FA470J	1210	430	MC12FA431J	1210			
50	MC12FA500J	1210	250	MC18FA251J	1812			
51	MC12FA510J	1210	270	MC18FA271J	1812			

Type MC, Surface-Mount Mica Chip Capacitors

Chip and SMT Capacitors

Ratings

Cap pF	Catalog Number	Case Type	Cap pF	Catalog Number	Case Type	Cap pF	Catalog Number	Case Type	Cap pF	Catalog Number	Case Type
500 Vdc			500 Vdc			1000 Vdc			1000 Vdc		
1	MC12CD010D	1210	120	MC18FD121J	1812	1	MC12CF010D	1210	100	MC22FF101J	2220
2	MC12CD020D	1210	130	MC18FD131J	1812	2	MC12CF020D	1210	110	MC22FF111J	2220
3	MC12CD030D	1210	150	MC18FD151J	1812	3	MC12CF030D	1210	120	MC22FF121J	2220
4	MC12CD040D	1210	100	MC12FD101J	1210	4	MC12CF040D	1210	130	MC22FF131J	2220
5	MC12CD050D	1210	110	MC12FD111J	1210	5	MC12CF050D	1210	150	MC22FF151J	2220
6	MC12CD060D	1210	120	MC12FD121J	1210	6	MC12CF060D	1210	160	MC22FF161J	2220
7	MC12CD070D	1210	130	MC12FD131J	1210	7	MC12CF070D	1210	180	MC22FF181J	2220
8	MC12CD080D	1210	150	MC12FD151J	1210	8	MC12CF080D	1210	200	MC22FF201J	2220
9	MC12CD090D	1210	160	MC18FD161J	1812	9	MC12CF090D	1210	220	MC22FF221J	2220
10	MC12CD100D	1210	180	MC18FD181J	1812	10	MC12CF100D	1210	240	MC22FF241J	2220
12	MC12ED120J	1210	200	MC18FD201J	1812	12	MC12EF120J	1210	250	MC22FF251J	2220
15	MC12ED150J	1210	220	MC18FD221J	1812	15	MC12EF150J	1210	270	MC22FF271J	2220
18	MC12ED180J	1210	240	MC18FD241J	1812	18	MC12EF180J	1210	300	MC22FF301J	2220
20	MC12ED200J	1210	250	MC18FD251J	1812	20	MC12EF200J	1210	330	MC22FF331J	2220
22	MC12ED220J	1210	270	MC18FD271J	1812	22	MC12EF220J	1210	360	MC22FF361J	2220
24	MC12ED240J	1210	300	MC18FD301J	1812	24	MC12EF240J	1210	390	MC22FF391J	2220
27	MC12ED270J	1210	330	MC18FD331J	1812	27	MC12EF270J	1210	430	MC22FF431J	2220
30	MC12ED300J	1210	360	MC18FD361J	1812	30	MC12EF300J	1210	470	MC22FF471J	2220
33	MC12FD330J	1210	390	MC18FD391J	1812	33	MC12FF330J	1210	500	MC22FF501J	2220
36	MC12FD360J	1210	430	MC18FD431J	1812	36	MC12FF360J	1210	510	MC22FF511J	2220
39	MC12FD390J	1210	470	MC18FD471J	1812	39	MC12FF390J	1210	560	MC22FF561J	2220
43	MC12FD430J	1210	500	MC22FD501J	2220	43	MC12FF430J	1210	620	MC22FF621J	2220
47	MC12FD470J	1210	510	MC22FD511J	2220	47	MC12FF470J	1210	680	MC22FF681J	2220
50	MC12FD500J	1210	560	MC22FD561J	2220	50	MC12FF500J	1210	750	MC22FF751J	2220
51	MC12FD510J	1210	620	MC22FD621J	2220				820	MC22FF821J	2220
56	MC12FD560J	1210	680	MC22FD681J	2220				910	MC22FF911J	2220
62	MC12FD620J	1210	750	MC22FD751J	2220				1000	MC22FF102J	2220
68	MC12FD680J	1210	820	MC22FD821J	2220				1100	MC22FF112J	2220
75	MC12FD750J	1210	910	MC22FD911J	2220				1200	MC22FF122J	2220
82	MC12FD820J	1210	1000	MC22FD102J	2220				1500	MC22FF152J	2220
91	MC12FD910J	1210	1100	MC22FD112J	2220						
100	MC18FD101J	1812	1200	MC22FD122J	2220						
110	MC18FD111J	1812									

Typical Characteristic Curves

Q vs. CAPACITANCE

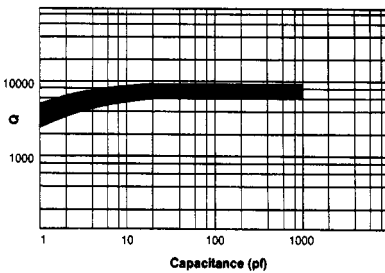

CAPACITANCE vs. FREQUENCY

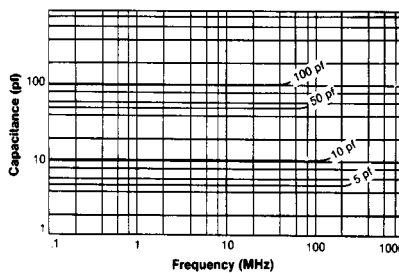

Q vs. FREQUENCY

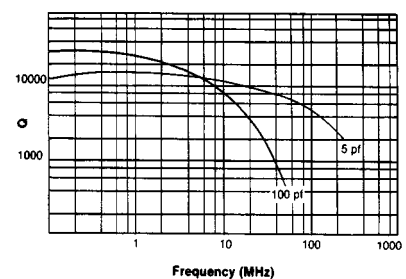

% CAPACITANCE CHANGE vs. TEMPERATURE

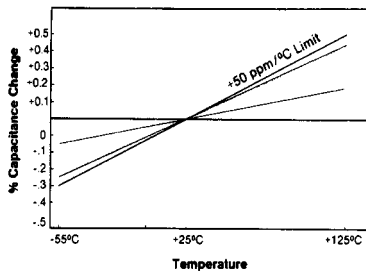

IMPEDANCE vs. FREQUENCY

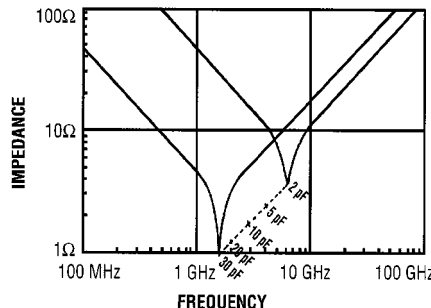

RESONANT FREQUENCY vs. CAPACITANCE

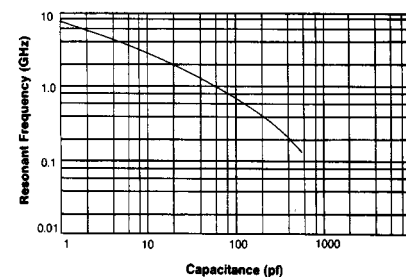

Type MC, Surface-Mount Mica Chip Capacitors

Specifications

Marking

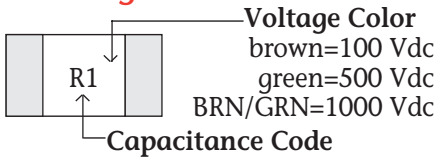

Base Value	Code Ltr.	Base Value	Code Ltr.
10	A	40	d
11	B	43	R
12	C	45	e
13	D	47	S
15	E	50	f
16	F	51	T
18	G	56	U
20	H	60	m
22	J	62	V
24	K	68	W
25	a	70	n
27	L	75	X
30	M	80	t
33	N	82	Y
35	b	90	y
36	P	91	Z
39	Q		

Example:
R1 = 43 pF

Multiplier	Code No.
X 0.1	0
X 1	1
X 10	2
X 100	3
X 0.01	9

Capacitance is within tolerance when measured as follows:
1–1000 pF @ 1 MHz
> 1000 pF @ 1 kHz

Dissipation Factor is no more than 0.1% when measured as above.

Quality Factor (Q) is as follows when measured at 1 MHz.

Capacitance Range	Min. Q
1 to 80 pF	500 to 3000
>80 pF	3000

Insulation Resistance is no less than 100 GΩ when measured at 100 Vdc.

Withstanding Voltage is two times the rated voltage and can be applied up to 5 seconds without damage.

Life Test: Subject capacitors to 125±3°C with 1.5 times rated voltage applied for 2000 (+72,–0) hours. There will be no visual damage and the capacitors will meet the limits of the table below.

Vibration Resistance: Subject the capacitors to simple harmonic motion with an amplitude of 0.06 inches; vary the frequency uniformly from 10 to 55 Hz and return to 10 Hz, all in one minute. Repeat that cycle continuously for two hours in each of three mutually perpendicular directions. There will be no visual damage and the capacitors will meet the limits of the table below.

Bending Test: Solder attach the capacitors to printed-circuit boards. Suspend each board between two edges separated 3.5 inches with the capacitor in the center and on the

underside. Press in the center of the suspension until the board flexes downward 0.1 inches. There will be no visual damage and the capacitors will meet the limits of the table below during and after the bending.

Moisture Resistance: Subject the capacitors to 40±2°C at 90 to 95% humidity for 500 (+24,–0) hours. Return to room ambient for 24 hours. There will be no visual damage and the capacitors will meet the limits of the table below.

Temperature Coefficient and Drift: Measure the capacitors' capacitance at 25°C, –55°C, 25°C, 125°C, and at 25°C—all ±3°C—after stabilizing at each temperature. The capacitance will meet the limits of the Characteristic table in Ordering Information.

Heat Resistance: Subject the capacitors to 125±2°C for 2 (+1,–0) hours. Then the insulation resistance will be no less than 5GΩ.

Solderability: After 2±0.5 seconds in molten solder with 2.5% silver at 270±5°C, solder coverage will be no less than 90% when examined at 10X magnification for flow soldering and no less than 75% for reflow soldering.

Solder Heat Resistance: Subject the capacitors to molten solder as above with 5 minutes preheating at 150±3°C. There will be no visual damage and the capacitors will meet the limits of the table below.

After-Test Limits

Test	Withstand Voltage	Insulation Resistance	Capacitance (whichever >)	DF	Q
Life Test	IL	IL	IV±2% or ±.5pF	150% max IL	2/3xIL
Vibration Resistance	IL	30 GΩ	IV±1% or ±1pF	IL	IL
Bending Test	IL		IV±.5% or ±1pF	IL	
Moisture Res.	IL	30 GΩ	IV±3% or ±.5pF	150% max IL	2/3xIL
Solderability	IL	IL	IL	IL	IL
Heat Resistance		5 GΩ			
Solder Heat Res.	IL	30 GΩ	IV±.5% or ±1pF	IL	IL

IL=Initial Limit IV=Initial Value

1605 East Rodney French Blvd.
New Bedford, MA 02744
(508) 996-8564, Fax (508) 996-3830
<http://www.cornell-dubilier.com>
E-mail: cdendb@cornell-dubilier.com

CDE **CORNELL DUBILIER**
www.DataSheet4U.com
Your Source For Capacitor Solutions

Type MC, Surface-Mount Mica Chip Capacitors

Ordering Information

Order by complete part number, as below. For other options, write your requirements on your quote request.

Surface-Mount Chip Mica Capacitors

MC | **22** | **F** | **D** | **122** | **J** - **I**
CDE Type | **Case Code** | **Characteristic** | **Voltage** | **Capacitance** | **Package**
 A = 100 Vdc | 010 = 1pF | leave blank for bulk
 D = 500 Vdc | 1R8 = 1.8pF | add "-T" for reel or tape
 F = 1000 Vdc | (187) = 187pF
 182 = 1800pF

Char Code	Capacitance Range pF	Temperature Coefficient ppm/°C	Capacitance Drift
C	0.5 to 10	100±100	±(.5% +0.1 pF)
E	10.5 to 30	50±50	±(.1%+0.1 pF)
F	30.5 & up	25±25	±(.05%+1 pF)

Tol. Code	Tolerance	Capacitance Range
B	±0.1 pF	0.5 pF to 10 pF
C	±0.25 pF	0.5 pF to 99.5 pF
D	±0.5 pF	0.5 pF to 10 pF
F	±1 pF	0.5 pF to 10 pF
C	±0.25%	100 pF and up
D	±0.5%	50.5 pF and up
F	±1 %	25.5 pF and up
G	±2%	13 pF and up
J	±5%	10.5 pF and up

Available Capacitance Values

Case Code	Capacitance, pF			Minimum Cap. Step, pF
	100 Vdc	500 Vdc	1000 Vdc	
08	0.5 to 43	N/A	N/A	0.5
12	43.5 to 100	0.5 to 100	N/A	0.5
12	101 to 430	101 to 150	N/A	1.0
12			1 to 50	1.0
18	250 to 820	100 to 470	N/A	1.0
22	821 to 1000	471 to 1000	N/A	1.0
22	1010 to 2000	1010 to 1200	100 to 1500	10.0

Standard Minimum Shipping Quantities

Reel Packed
 Case Codes 08 & 12: 3,000/reel
 Case Codes 18 & 22: 1,000/reel

Bulk Packed
 100 per bag

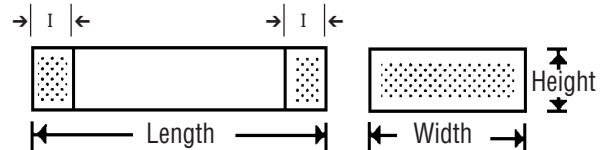

—Solder-coated
 —Nickel/Silver Termination

Case Sizes

Case Code	Case Type	INCHES				MILLIMETERS			
		L	W	H	I min/max	L	W	H	I min/max
08	0805	.079 ⁺⁰² ₋₀	.049 ⁺⁰² ₋₀	.055	.008/.035	2.0 ⁺⁵ ₋₀	1.25 ⁺⁵ ₋₀	1.4	.2/.9
12	1210	.126 ⁺⁰²⁴ _{-.004}	.098 ⁺⁰²⁴ _{-.004}	.079	.012/.043	3.2 ⁺⁶ _{-.1}	2.5 ⁺⁶ _{-.1}	2.0	.3/1.1
18	1812	.177 ⁺⁰²⁴ _{-.008}	.126 ⁺⁰²⁴ ₋₀	.079	.012/.051	4.5 ⁺⁶ _{-.2}	3.2 ⁺⁶ ₋₀	2.0	.3/1.3
22	2220	.224 ⁺⁰¹⁶ _{-.012}	.197 ⁺⁰¹⁶ _{-.012}	.079*	.012/.051	5.7 ⁺⁴ _{-.3}	5.0 ⁺⁴ _{-.3}	2.0*	.3/1.3

*.157 (4.0 mm) for 1000 V rating

Type MC, Surface-Mount Mica Chip Capacitors

Surface-Mount Chip Mica Capacitors for Auto Insertion

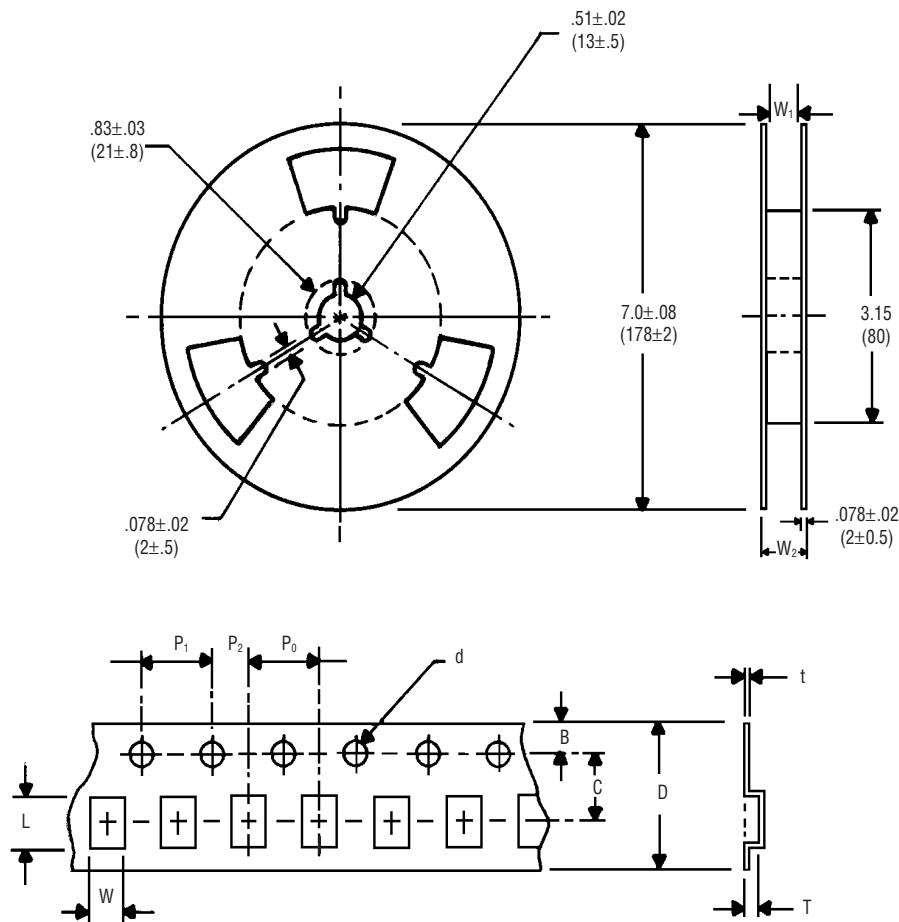

Carrier Dimensions

Item	Symbol	Case Code			
		08	12	18	22
Sprocket hole pitch	P ₁	.157±.008 (4.0±0.2)			
Sprocket hole location	B	.069±.008 (1.75±0.2)			
Hole center to cavity center	C	.138±.002 (3.5±0.05)		.217±.004 (5.5±0.1)	
Carrier tape width	D	.315±.012 (8.0±0.3)		.472±.012 (12.0±0.3)	
Sprocket hole diameter	d	.059 ^{+.002} ₀ (1.5 ^{+.1} ₀)			
Cavity pitch	P ₀	.157±.004 (4.0±0.1)		.315±.008 (8.0±0.2)	
Hole center to cavity center	P ₂	.079±.004 (2.0±0.1)			
Cavity length	L	.110 ^{+.008} _{-.004} (2.8 ^{+.2} _{-0.1})	.150 ^{+.008} _{-.004} (3.8 ^{+.2} _{-0.1})	.205 ^{+.008} _{-.004} (5.2 ^{+.2} _{-0.1})	.246 ^{+.008} _{-.004} (6.25 ^{+.2} _{-0.1})
Cavity width	W	.075±.008 (1.9±0.2)	.118±.008 (3.0±0.2)	.161±.008 (4.1±0.2)	.217±.008 (5.5±0.2)
Cavity depth	T	.051±.004 (1.3±0.1)	.059±.004 (1.5±0.1)	.071±.004 (1.8±0.1)	.087±.004 (2.2±0.1)
Carrier tape thickness	t	.012±.002 (0.3±0.05)			
Holder distance	W ₁	.354 ^{+.08} _{-.02} (9.0 ^{+.2} _{-0.5})		.512 ^{+.08} _{-.02} (13.0 ^{+.2} _{-0.5})	
Reel thickness	W ₂	about .47 (12)		about .63 (16)	