

Complementary Silicon power transistors (20A / 140V / 250W)

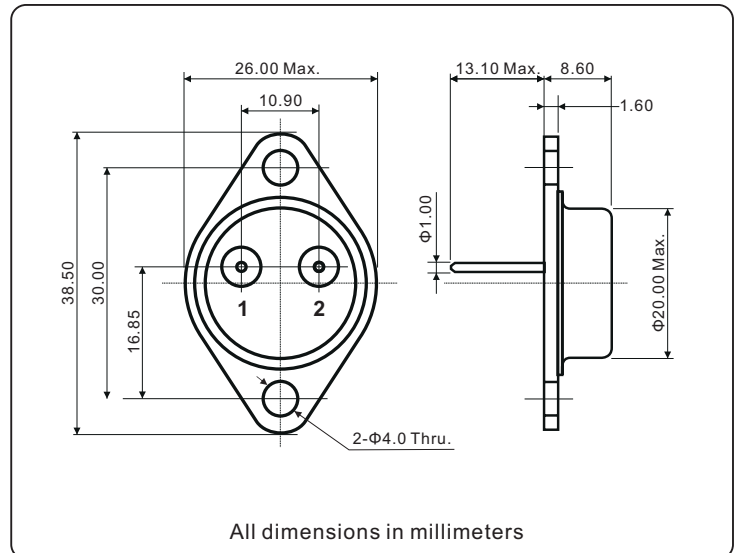
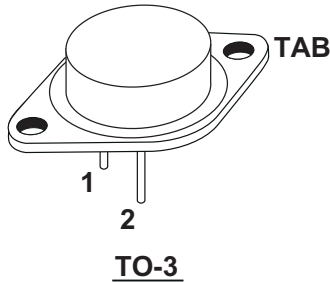

FEATURES

- Designed for general-purpose switching and amplifier applications.
- DC current gain- $h_{FE} = 25$ (Min) @ $I_C = 5$ Adc
- High safe operation area (100% tested) 250W @ 50V
- For low distortion complementary designs

DESCRIPTION

The **MJ15003** is a silicon epitaxial-base planar NPN transistor mounted in JEDEC TO-3 metal case.

It is designed for high power audio, disk head positioners and other linear applications.

The complementary PNP type is **MJ15004**.

INTERNAL SCHEMATIC DIAGRAM

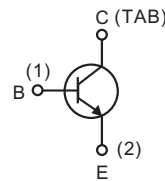

MJ15003(NPN)

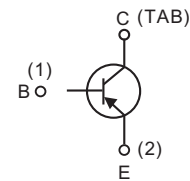

MJ15004(PNP)

ABSOLUTE MAXIMUM RATINGS ($T_C = 25^\circ\text{C}$ unless otherwise specified)			
SYMBOL	PARAMETER		UNIT
V_{CBO}	Collector to base voltage ($I_E = 0$)		V_{dc}
V_{CEO}	Collector to emitter voltage ($I_B = 0$)		
V_{EBO}	Emitter to base voltage		
I_C	Collector current - continuous		A_{dc}
I_B	Base current - continuous		
I_E	Emitter current - continuous		
P_D	Total power dissipation	$T_C = 25^\circ\text{C}$	W
	Derate above 25°C		$W/^\circ\text{C}$
T_j	Junction temperature		$^\circ\text{C}$
T_{stg}	Storage temperature		
T_L	Maximum lead temperature for soldering purposes : 1/16" from case for ≤ 10 seconds		

*For PNP types voltage and current values are negative.

THERMAL CHARACTERISTICS ($T_C = 25^\circ\text{C}$ unless otherwise specified)			
SYMBOL	PARAMETER	VALUE	UNIT
$R_{th(j-c)}$	Thermal resistance, junction to case	0.7	$^\circ\text{C}/\text{W}$

ELECTRICAL CHARACTERISTICS ($T_C = 25^\circ\text{C}$ unless otherwise specified)					
SYMBOL	PARAMETER	CONDITIONS	MIN	MAX	UNIT
I_{CEX}	Collector cutoff current	$V_{CE} = 140\text{V}, V_{BE(off)} = 1.5\text{V}$		100	μA
		$V_{CE} = 140\text{V}, V_{BE(off)} = 1.5\text{V}, T_C = 150^\circ\text{C}$		2.0	mA
I_{CEO}	Collector cutoff current	$V_{CE} = 140\text{V}, I_B = 0$		250	μA
I_{EBO}	Emitter cutoff current	$V_{EBO} = 5\text{V}, I_C = 0$		100	
$V_{CEO(SUS)}^*$	Collector to emitter sustaining voltage	$I_C = 200\text{mA}, I_B = 0$	140		V
V_{CBO}	Collector to base voltage	$I_E = 0$	140		
V_{EBO}	Emitter to base voltage	$I_C = 0$	5		
h_{FE}	Forward current transfer ratio (DC current gain)	$I_C = 5\text{A}, V_{CE} = 2\text{V}$	25	150	
$V_{CE(sat)}^*$	Collector to emitter saturation voltage	$I_C = 5\text{A}, I_B = 0.5\text{A}$		1.0	V
$V_{BE(on)}^*$	Base to emitter on voltage	$I_C = 5\text{A}, V_{CE} = 2\text{V}$		2.0	
f_T	Transition frequency (current gain - bandwidth product)	$I_C = 0.5\text{A}, V_{CE} = 10\text{V}, f_{test} = 0.5\text{MHz}$	2.0		MHz
C_{ob}	Output capacitance	$V_{CB} = 10\text{V}, I_E = 0, f_{test} = 1\text{MHz}$		1000	pF
$I_{s/b}^*$	Second breakdown collector current with base forward biased	$V_{CE} = 50\text{V}, t = 1\text{s}, \text{non-repetitive}$	5		A
		$V_{CE} = 100\text{V}, t = 1\text{s}, \text{non-repetitive}$	1		

*Pulsed : Pulse duration = 300 μs , duty cycle 2%.

*For PNP types voltage and current values are negative.

Fig.1 Power derating

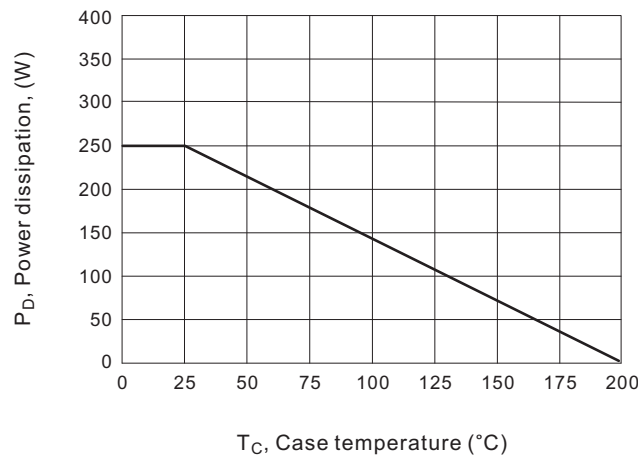
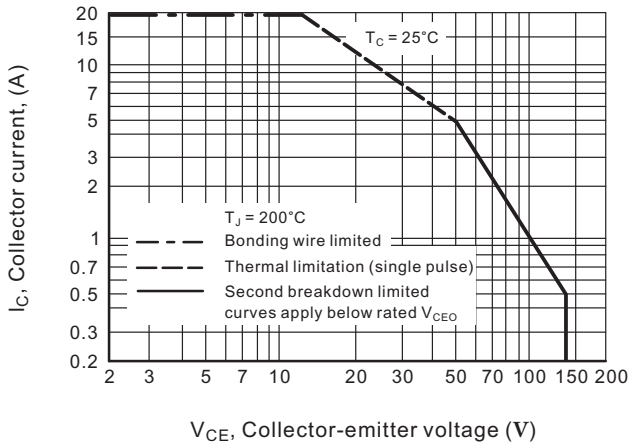

Fig.2 Active region safe operating area



There are two limitations on the power handling ability of a transistor: average junction temperature and second breakdown. Safe operating area curves indicate I_C - V_{CE} limits of the transistor that must be observed for reliable operation; i.e., the transistor must not be subjected to greater dissipation than the curves indicate.

The data of fig.2 is based on $T_{J(pk)} = 200^\circ\text{C}$; T_C is variable depending on conditions. At high case temperatures, thermal limitations will reduce the power that can be handled to values less than the limitations imposed by second breakdown.

Fig.3 DC Current gain

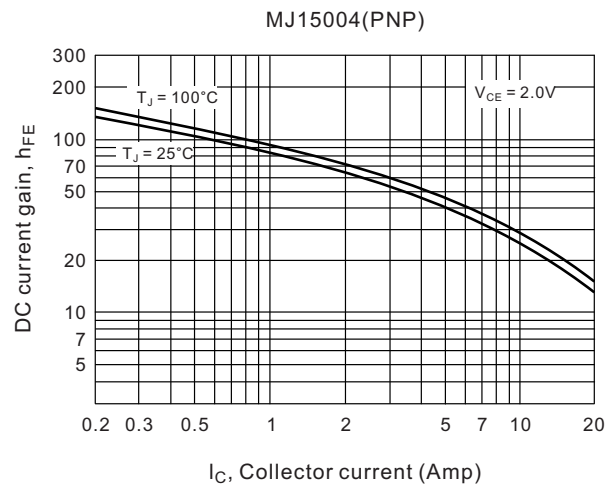
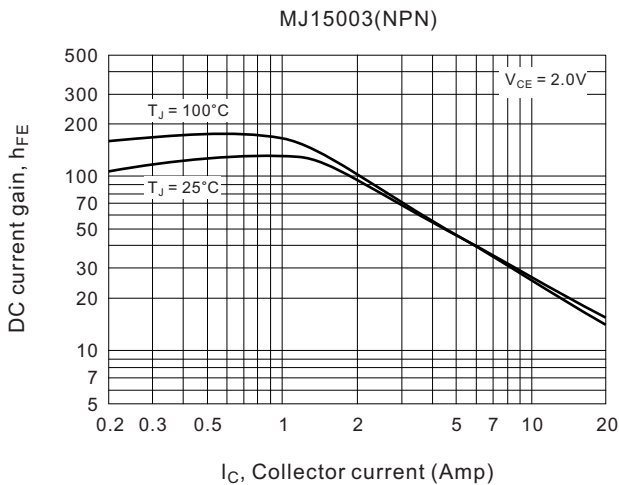

Fig.4 "ON" Characteristics

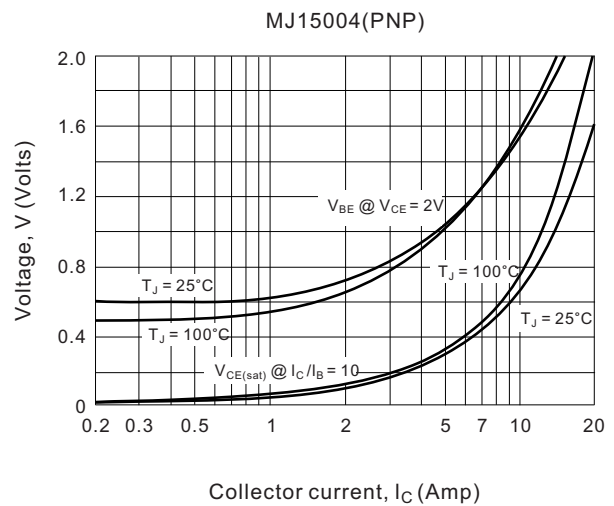
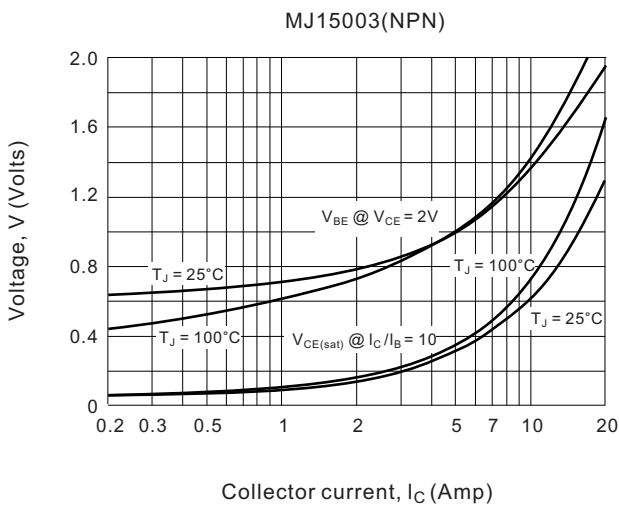

Fig.5 Capacitances

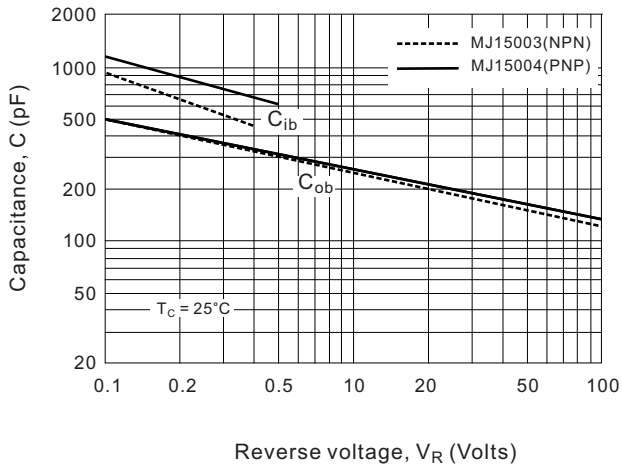

Fig.6 Transition frequency (Current Gain-Bandwidth product)

