

XUAN 1919 烜

36V/13W series



Introduction

Everlight's COB Series is an aluminum substrate based LED achieving high efficiency while maintaining high CRI at Energy Star / ANSI color temperature ranges.

Features

- ◆ High Power COB & High CRI LED
- ◆ Multi-Chip Solution
- ◆ Dimension: 19 mm x 19 mm x 1.6 mm
- ◆ Main Parameters: Luminous Flux, Forward Voltage, Chromaticity and Color Rendering Index
- ◆ RoHS compliant
- ◆ Energy Star / ANSI Compliant Binning Structure
- ◆ Typical Viewing Angle: 115°

Applications

- ◆ Replacement Bulb
- ◆ Indoor General Lighting
- ◆ Recessed Can Lighting

Table of Contents

Product Nomenclature	3
Absolute Maximum Ratings	4
PN of the XUAN1919 36V/13W series:White LEDs	5
Product Binning:Luminous Flux Bins	6
Prodcut Binning:Warm White Bin Structure	7
Product Binning:Warm White Bin Coordinates	9
Prodcut Binning:Neutral White Bin Structure	9
Product Binning:Neutral White Bin Coordinates	8
Prodcut Binning:Cool White Bin Structure	10
Product Binning:Cool White Bin Coordinates	10
Product Binning:Forward Voltage Bins	12
Mechanical Dimension	13
Pad Configuration	14
Typical Electro-Optical Characteristic Curve	15
Product Labeling	20
Carrier Tray Specification	20
Precautions of Use	23
Revision History	24

Product Nomenclature

The product name is designated as below:

XUAN1919-CDEFGHJ-KLMNP-QRST

Family name
XUAN1919

Designation:

CD = lighting color and wavelength^[1]

EF = color bin or CCT bin

G = internal code

HJ = min. luminous flux (lm) or radiation power (mW) performance

KL = forward voltage bin^[2]

M = internal code

NP = power consumption^[3]

Q= internal code

R= Dam Diameter^[4]

S= internal code

T=Type of Package^[5]

Notes

1. Table of lighting color and wavelength

Symbol	Color	CCT range	Color Rendering Index
GT	Cool-White	4745~7050K	>65
KT	Cool-White	4745~7050K	>80
LM	Warm-White	2580~3710K	>70
	Neutral-White	3710~4745K	
KM	Warm White	2580~3710K	>80
	Neutral-White	3710~4745K	

2. Table of forward voltage bin

Symbol	Description
36	36V Input Voltage

3. Power consumption:

Symbol	Description
13	13W

4. Dam Diameter:

Symbol	Description
E	14.0-14.9mm

5. Table of packaging types:

Symbol	Description
T	Tray

Absolute Maximum Ratings

Parameter	Symbol	Ratings	Unit
Max. DC Forward Current (mA) _{[4],[5]}	I_F	720	mA
Max. Pulse Forward Current (mA)	I_P	1080	mA
Power Dissipation	P_d	28.5	W
Thermal Resistance	R_{th}	0.85	°C/W
Max. Junction Temperature	T_J	120	°C
Operating Temperature _{[4],[5]}	T_{Opr}	-40 ~ +85	°C
Storage Temperature	T_{Stg}	-40 ~ +85	°C

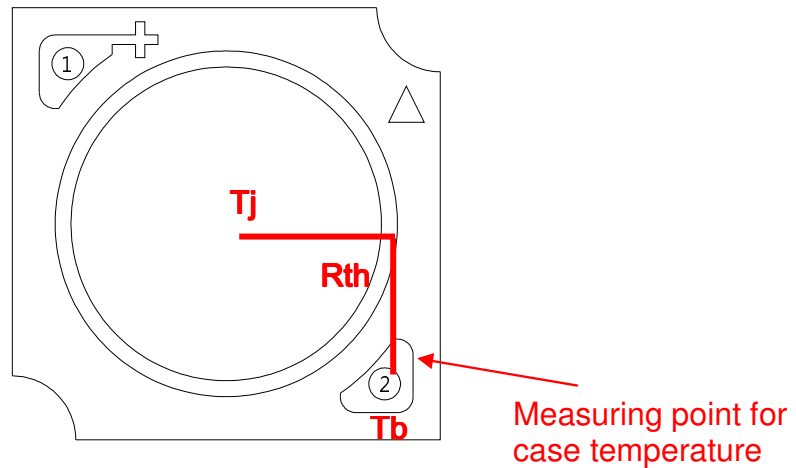

Notes:

1. For optimal performance, Everlight recommends 360mA operation.
2. $t_p \leq 100ms$, Duty cycle = 25%
3. The XUAN1919 36V/13W series LEDs are not designed for reverse bias use.
4. Power dissipation and forward current are the value when the module temperature is set lower than the rating by using an adequate heat sink.
5. $T_b = 25\text{ }^\circ\text{C}$

PN of the XUAN1919 Series : White LEDs



Color	Order Code of XUAN1919	Minimum Luminous Flux (lm)	Typical Luminous Flux (lm)	CCT (K)	Forward Voltage (V)	Forward Current (mA)	CRI (min.)
Warm White 2700	XUAN1919-KM277P4-36613-3E0T	1200	1495	27K-1~27K-4	33.0~41.0	360	80
Warm White 3000	XUAN1919-KM307P5-36613-3E0T	1350	1570	30K-1~30K-4	33.0~41.0	360	80
Warm White 3500	XUAN1919-KM357P5-36613-3E0T	1350	1615	35K-1~35K-4	33.0~41.0	360	80
Neutral White 4000	XUAN1919-KM407P5-36613-3E0T	1350	1660	40K-1~40K-4	33.0~41.0	360	80
Neutral White 4500	XUAN1919-KM457P6-36613-3E0T	1500	1685	45K-1~45K-4	33.0~41.0	360	80
Cool White 5000	XUAN1919-KT507P6-36613-3E0T	1500	1715	50K-1~50K-4	33.0~41.0	360	80
Cool White 5700	XUAN1919-KT577P6-36613-3E0T	1500	1730	57K-1~57K-4	33.0~41.0	360	80
Cool White 6500	XUAN1919-KT657P6-36613-3E0T	1500	1730	65K-1~65K-4	33.0~41.0	360	80

Notes:

1. CRI measurement tolerance: ± 2 .
2. Luminous flux measurement tolerance: $\pm 10\%$.
3. The data of luminous flux measured at thermal pad=25°C
4. Typical luminous flux or light output performance is operated within the condition guided by this datasheet.

Product Binning

Luminous Flux Bins

Group	Bin	Minimum Photometric Flux (lm)	Maximum Photometric Flux (lm)
J	1	100	110
	2	110	120
	3	120	130
	4	130	140
	5	140	150
	6	150	160
	7	160	180
	8	180	200
	9	200	225
K	1	225	250
	2	250	275
	3	275	300
	4	300	325
	5	325	350
	6	350	375
	7	375	400
	8	400	425
	9	425	450
N	1	450	475
	2	475	500
	3	500	550
	4	550	600
	5	600	650
	6	650	700
	7	700	750
	8	750	800
	9	800	900
P	1	900	1000
	2	1000	1100
	3	1100	1200
	4	1200	1350
	5	1350	1500
	6	1500	1650
	7	1650	1800
	8	1800	2000
	9	2000	2200

Group	Bin	Minimum Photometric Flux (lm)	Maximum Photometric Flux (lm)
S	1	2200	2400
	2	2400	2600
	3	2600	2800
	4	2800	3000
	5	3000	3200
	6	3200	3400
	7	3400	3600
	8	3600	3800
	9	3800	4000
M	1	4000	4200
	2	4200	4400
	3	4400	4600
	4	4600	4800
	5	4800	5000
	6	5000	5200
	7	5200	5400
	8	5400	5600
	9	5600	5800
Q	1	5800	6000
	2	6000	6200
	3	6200	6400
	4	6400	6600
	5	6600	6800
	6	6800	7000
	7	7000	7200
	8	7200	7400
	9	7400	7600

Warm-White Bin Structure

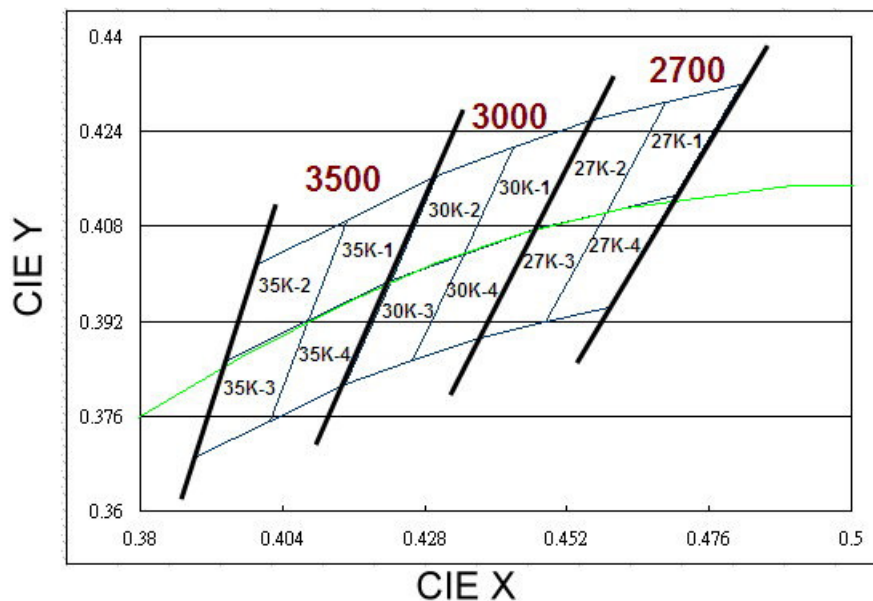

Warm-White Bin Coordinates

2700K

Bin	CIE X	CIE Y
27K-1	0.4582	0.4099
	0.4687	0.4289
	0.4813	0.4319
	0.4700	0.4126
Reference Range: 2580~2718K		

Bin	CIE X	CIE Y
27K-2	0.4465	0.4071
	0.4562	0.4260
	0.4687	0.4289
	0.4582	0.4099
Reference Range: 2718~2869K		

Bin	CIE X	CIE Y
27K-4	0.4483	0.3919
	0.4582	0.4099
	0.4700	0.4126
	0.4593	0.3944
Reference Range: 2580~2718K		

Bin	CIE X	CIE Y
27K-3	0.4373	0.3893
	0.4465	0.4071
	0.4582	0.4099
	0.4483	0.3919
Reference Range: 2718~2869K		

3000K

Bin	CIE X	CIE Y
30K-1	0.4342	0.4028
	0.4430	0.4212
	0.4562	0.4260
	0.4465	0.4071
Reference Range: 2870~3000K		

Bin	CIE X	CIE Y
30K-2	0.4221	0.3984
	0.4299	0.4165
	0.4430	0.4212
	0.4342	0.4028
Reference Range: 3000~3220K		

Bin	CIE X	CIE Y
30K-4	0.4147	0.3814
	0.4221	0.3984
	0.4342	0.4028
	0.4259	0.3853
Reference Range: 2870~3000K		

Bin	CIE X	CIE Y
30K-3	0.4259	0.3853
	0.4342	0.4028
	0.4465	0.4071
	0.4373	0.3893
Reference Range: 3000~3220K		

Warm-White Bin Structure

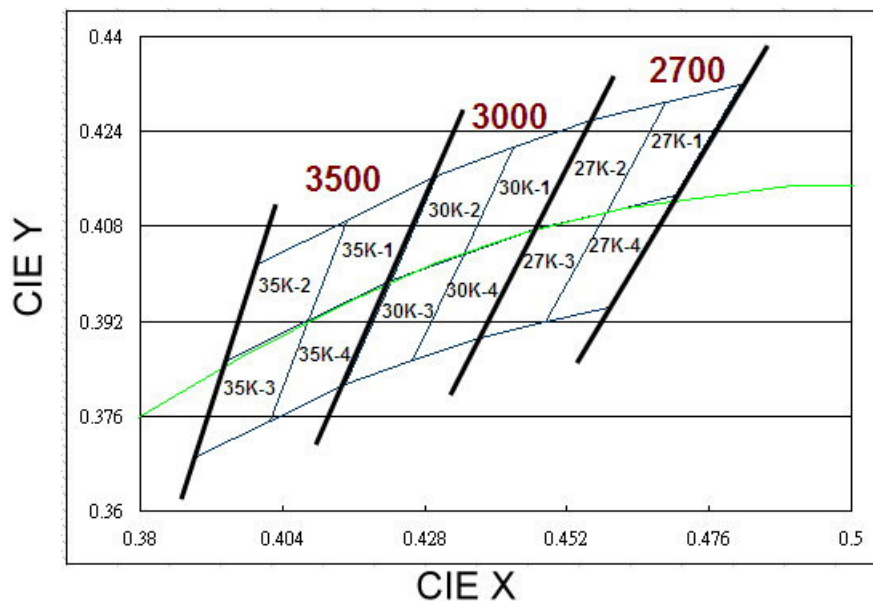

Warm-White Bin Coordinates

3500K

Bin	CIE X	CIE Y
35K-1	0.4080	0.3916
	0.4146	0.4089
	0.4299	0.4165
	0.4221	0.3984
Reference Range: 3209~3448K		

Bin	CIE X	CIE Y
35K-2	0.3941	0.3848
	0.3996	0.4015
	0.4146	0.4089
	0.4080	0.3916
Reference Range: 3449~3710K		

Bin	CIE X	CIE Y
35K-4	0.3889	0.3690
	0.3941	0.3848
	0.4080	0.3916
	0.4017	0.3751
Reference Range: 3209~3448K		

Bin	CIE X	CIE Y
35K-3	0.4017	0.3751
	0.4080	0.3916
	0.4221	0.3984
	0.4147	0.3814
Reference Range: 3449~3710K		

Neutral-White Bin Structure

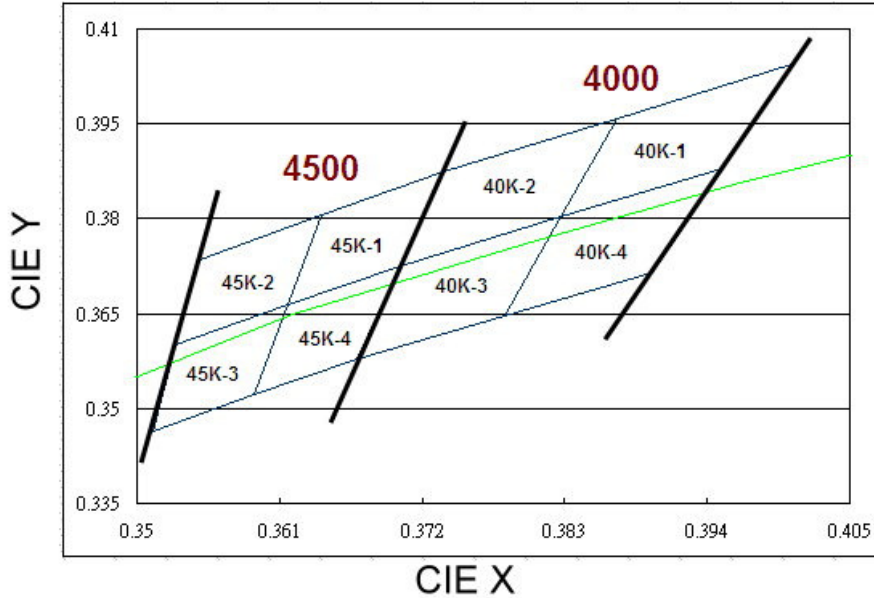

Neutral-White Bin Coordinates

4000K

Bin	CIE X	CIE Y
40K-1	0.3825	0.3798
	0.3869	0.3958
	0.4006	0.4044
	0.3950	0.3875
Reference Range: 3710~3967K		

Bin	CIE X	CIE Y
40K-2	0.3702	0.3722
	0.3736	0.3874
	0.3869	0.3958
	0.3825	0.3798
Reference Range: 3967~4259K		

Bin	CIE X	CIE Y
40K-4	0.3783	0.3646
	0.3825	0.3798
	0.3950	0.3875
	0.3898	0.3716
Reference Range: 3710~3967K		

Bin	CIE X	CIE Y
40K-3	0.3670	0.3578
	0.3702	0.3722
	0.3825	0.3798
	0.3783	0.3646
Reference Range: 3967~4259K		

4500K

Bin	CIE X	CIE Y
45K-1	0.3641	0.3804
	0.3736	0.3874
	0.3702	0.3722
	0.3615	0.3659
Reference Range: 4259~4490K		

Bin	CIE X	CIE Y
45K-2	0.3548	0.3736
	0.3641	0.3804
	0.3615	0.3659
	0.3530	0.3597
Reference Range: 4490~4744K		

Bin	CIE X	CIE Y
45K-4	0.3530	0.3597
	0.3615	0.3659
	0.3590	0.3521
	0.3512	0.3465
Reference Range: 4259~4490K		

Bin	CIE X	CIE Y
45K-3	0.3615	0.3659
	0.3702	0.3722
	0.3670	0.3578
	0.3590	0.3521
Reference Range: 4490~4744K		

Cool-White Bin Structure

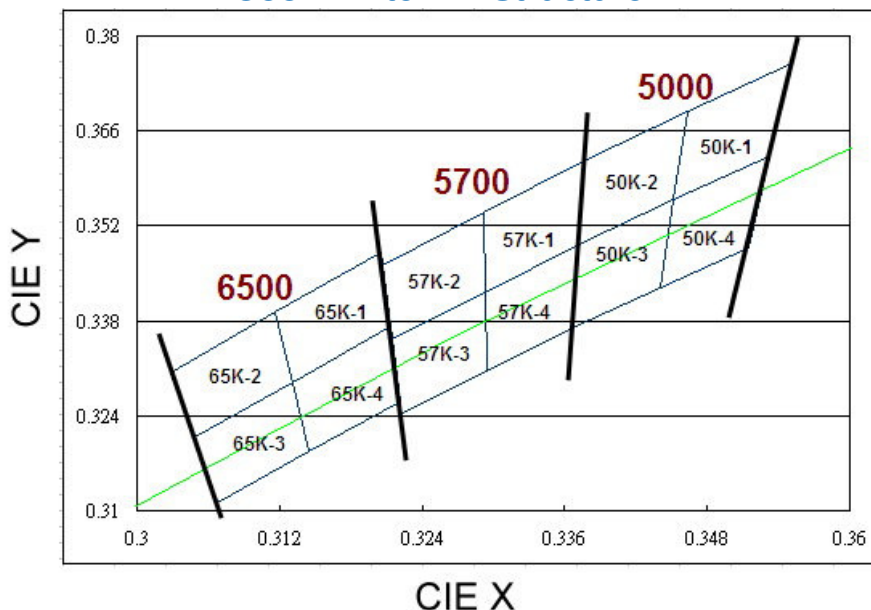

Cool-White Bin Coordinates

5000K

Bin	CIE X	CIE Y
50K-1	0.3463	0.3687
	0.3551	0.3760
	0.3533	0.3620
	0.3451	0.3554
Reference Range: 4743~5011K		

Bin	CIE X	CIE Y
50K-2	0.3376	0.3616
	0.3463	0.3687
	0.3451	0.3554
	0.3371	0.3490
Reference Range: 5013~5308K		

Bin	CIE X	CIE Y
50K-4	0.3451	0.3554
	0.3533	0.3620
	0.3515	0.3487
	0.3440	0.3427
Reference Range: 4743~5011K		

Bin	CIE X	CIE Y
50K-3	0.3371	0.3490
	0.3451	0.3554
	0.3440	0.3427
	0.3366	0.3369
Reference Range: 5013~5308K		

5700K

Bin	CIE X	CIE Y
57K-1	0.3290	0.3538
	0.3376	0.3616
	0.3371	0.3490
	0.3290	0.3417
Reference Range: 5308~5643K		

Bin	CIE X	CIE Y
57K-2	0.3207	0.3462
	0.3290	0.3538
	0.3290	0.3417
	0.3215	0.3350
Reference Range: 5643~6017K		

Bin	CIE X	CIE Y
57K-4	0.3290	0.3417
	0.3371	0.3490
	0.3366	0.3369
	0.3290	0.3300
Reference Range: 5308~5643K		

Bin	CIE X	CIE Y
57K-3	0.3215	0.3350
	0.3290	0.3417
	0.3290	0.3300
	0.3222	0.3243
Reference Range: 5643~6017K		

Cool-White Bin Structure

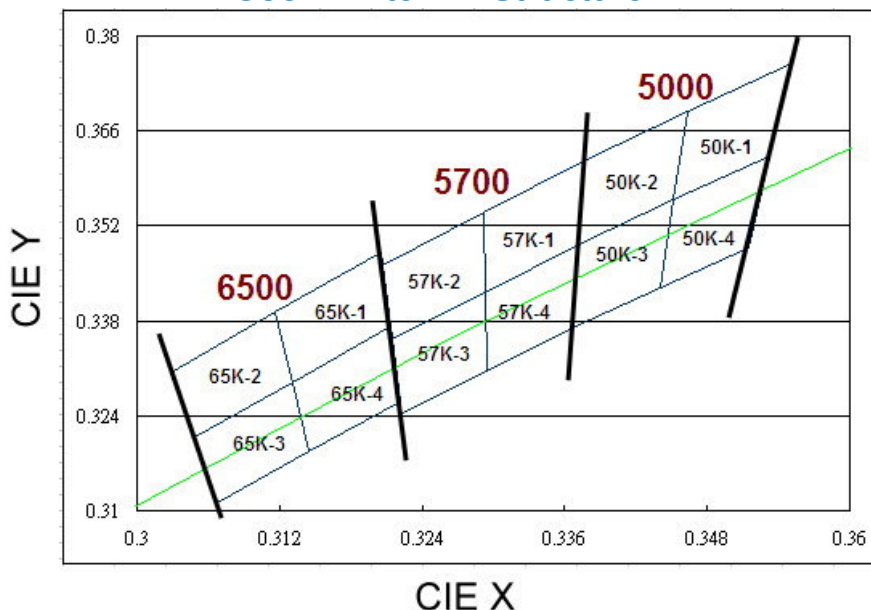

Cool-White Bin Coordinates

6500K

Bin	CIE X	CIE Y
65K-1	0.3115	0.3391
	0.3205	0.3481
	0.3213	0.3373
	0.3130	0.3290
Reference Range: 6018~6493K		

Bin	CIE X	CIE Y
65K-2	0.3028	0.3304
	0.3115	0.3391
	0.3130	0.3290
	0.3048	0.3207
Reference Range: 6487~7042K		

Bin	CIE X	CIE Y
65K-4	0.3130	0.3290
	0.3213	0.3373
	0.3221	0.3261
	0.3144	0.3186
Reference Range: 6018~6493K		

Bin	CIE X	CIE Y
65K-3	0.3048	0.3207
	0.3130	0.3290
	0.3144	0.3186
	0.3068	0.3113
Reference Range: 6487~7042K		

Notes:

1. Color coordinates measurement allowance : ± 0.01 .

Forward Voltage Bins

Bin	Minimum Forward Voltage (V)	Maximum Forward Voltage (V)
W4	33.0	35.0
W5	35.0	37.0
W6	37.0	39.0
W7	39.0	41.0

Notes:

1. Forward voltage measurement tolerance: $\pm 2\%$.
2. Forward voltage bins are defined at $I_f=360\text{mA}$ operation.
3. Other Forward Voltage bins for White LEDs available upon request. Please contact your local Everlight sales office.

Mechanical Dimension

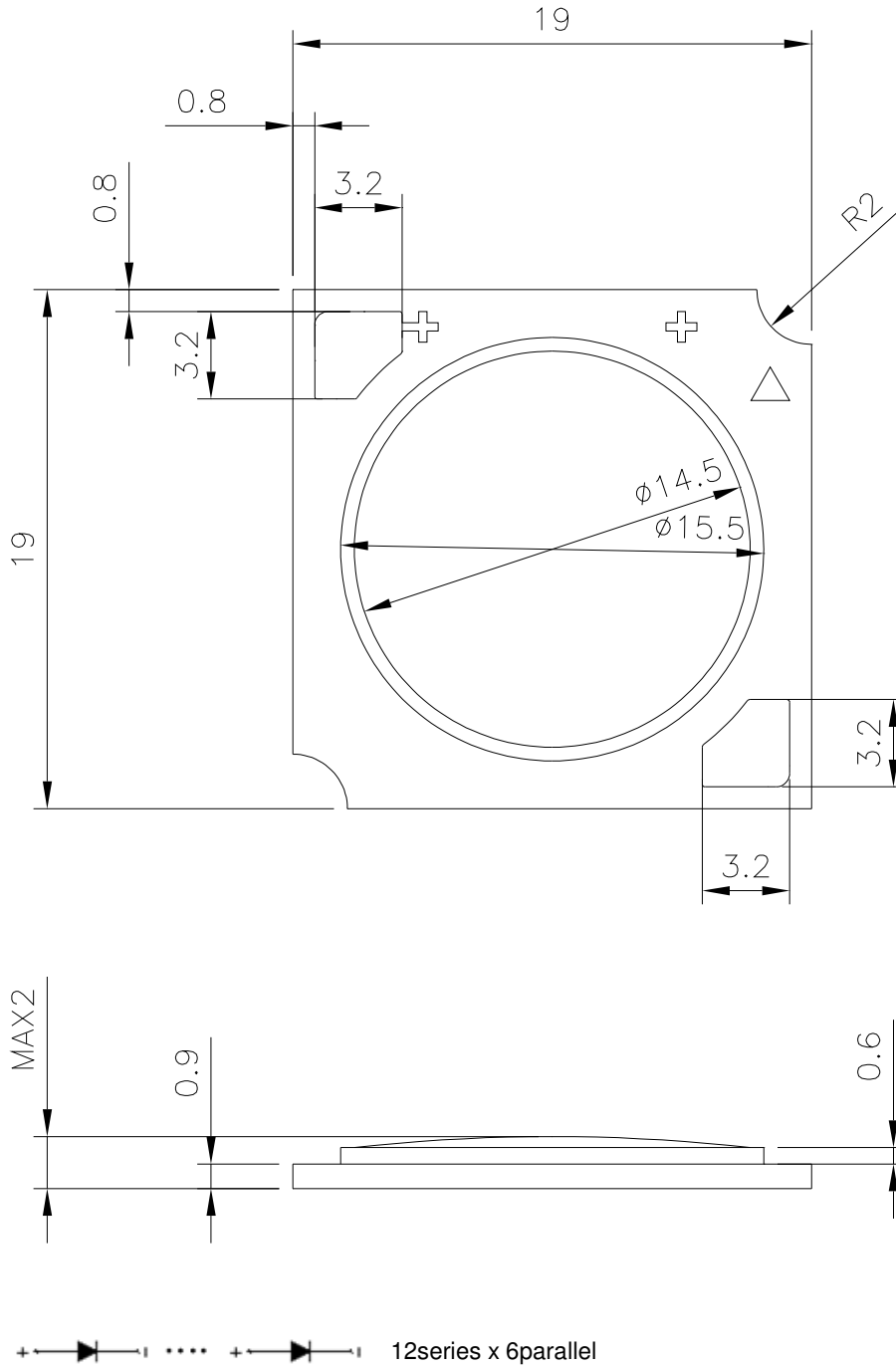

Note:

1. Dimensions are in millimeters.
2. Tolerances unless mentioned are ± 0.1 mm.

Pad Configuration

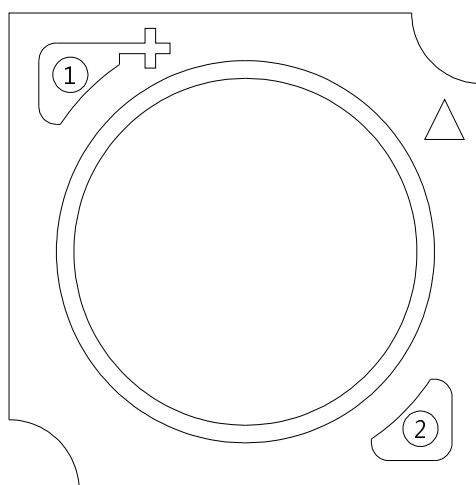

PAD	FUNCTION
1	ANODE
2	CATHODE

Typical Electro-Optical Characteristic Curve

Relative Spectral Distribution
@ Substrate Temperature = 25°C

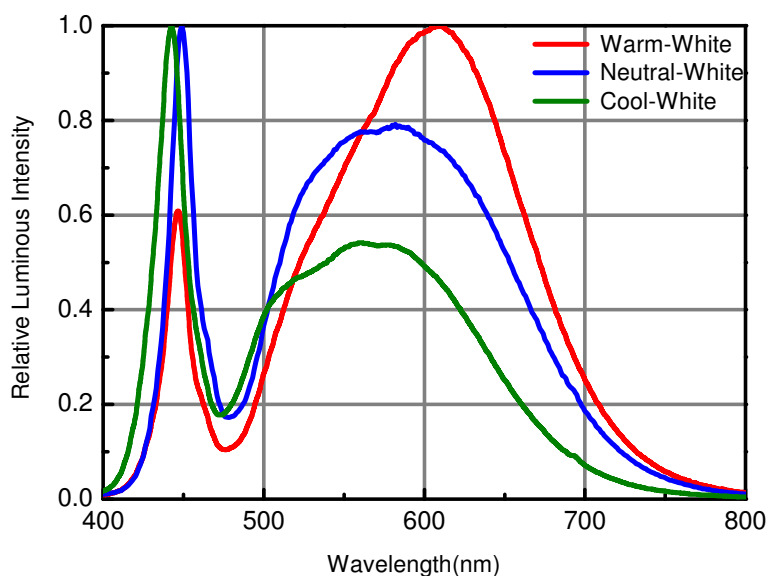

Relative Luminous Flux vs. Substrate Temperature
@Forward Current = 360mA

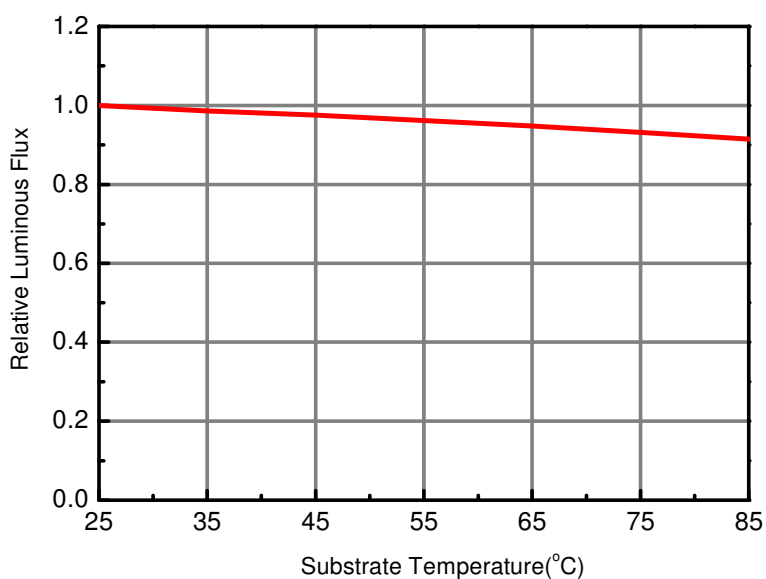

Forward Voltage vs. Forward Current
@ Substrate Temperature = 25°C

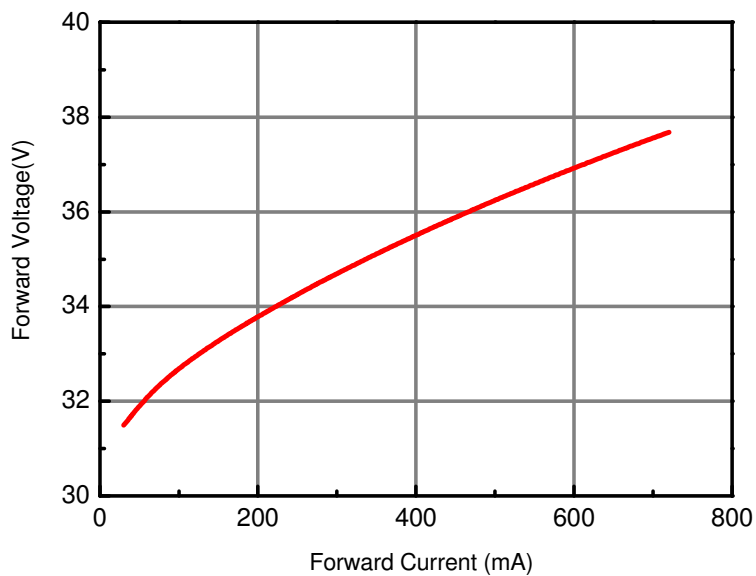

Luminous Flux vs. Forward Current
@ Substrate Temperature = 25°C

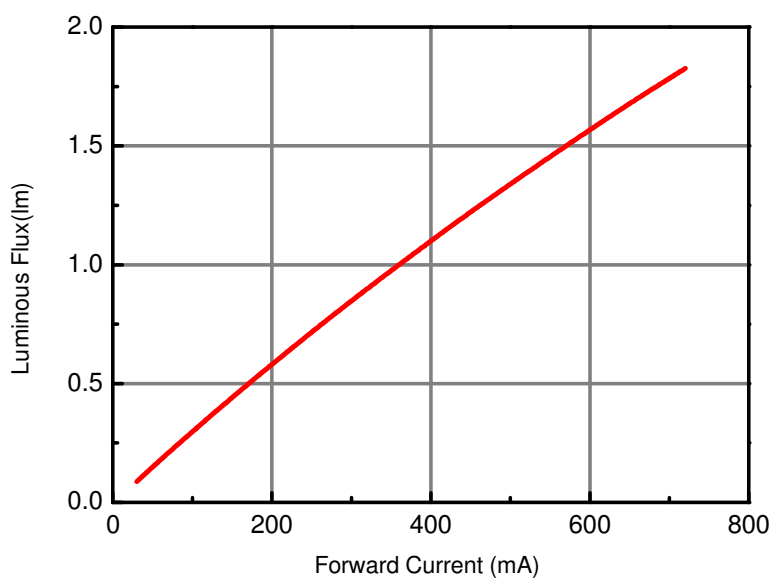

Correlated Color Temperature vs. Forward Current
@ Substrate Temperature = 25°C

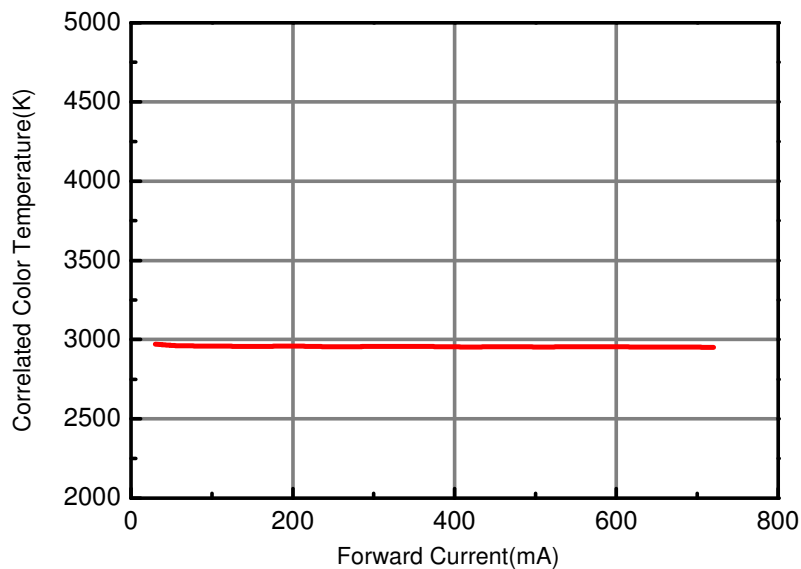

Correlated Color Temperature vs. Substrate Temperature
@ Forward Current = 360mA

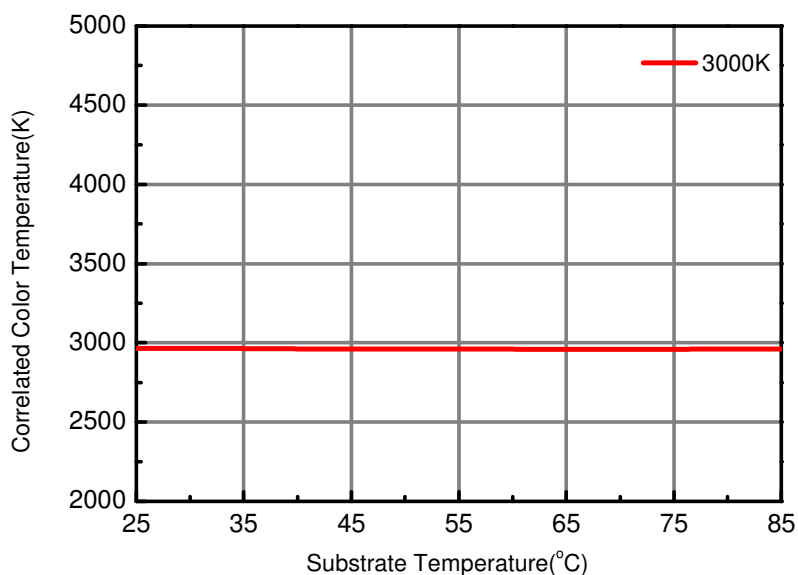

Forward Voltage vs. Substrate Temperature
@ Forward Current = 360mA

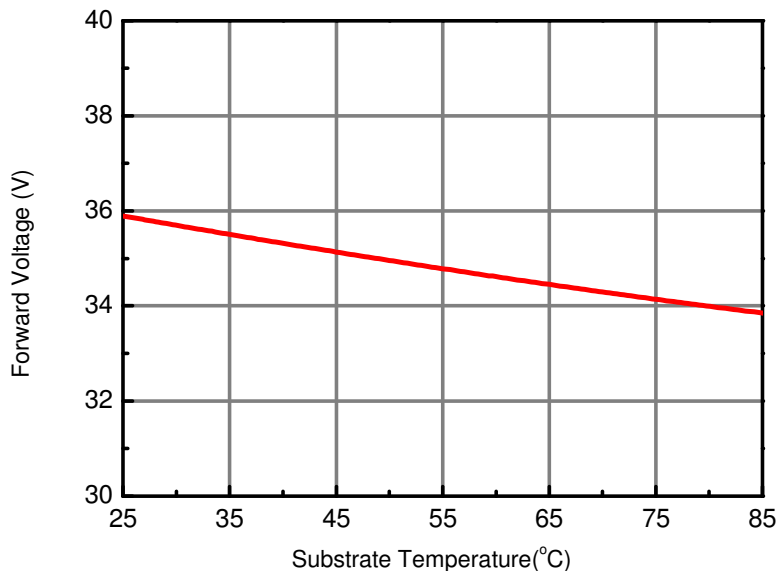

Forward Current Derating Curve
@ Junction Temperature <120°C

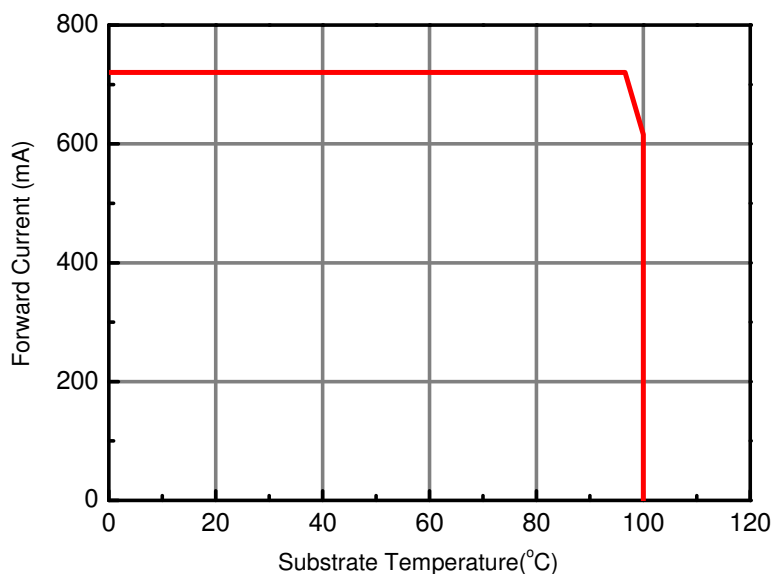

Typical Diagram Characteristics of Radiation Patterns

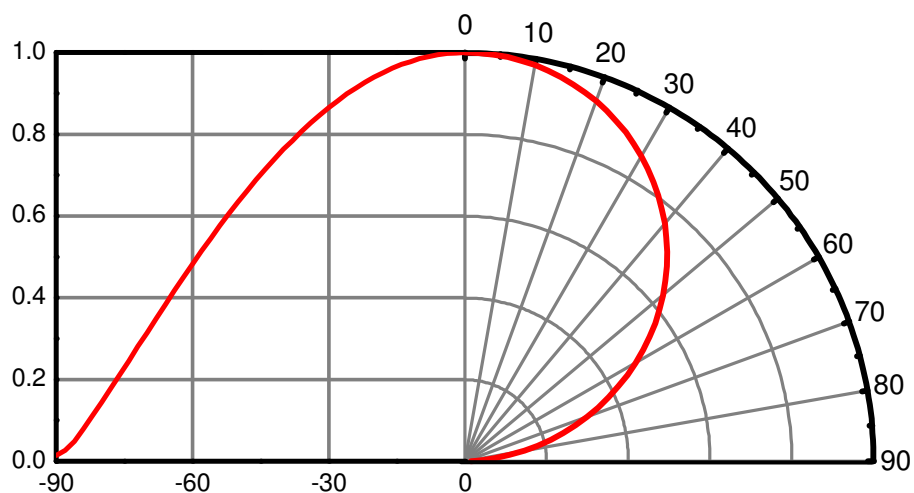

Notes:

1. $2\theta_{1/2}$ is the off axis angle from lamp centerline where the luminous intensity is 1/2 of the peak value.
2. Viewing angle tolerance is $\pm 5^\circ$

Product Labeling

Label Explanation

CPN: Customer Specification (when required)

P/N : Everlight Production Number

QTY: Packing Quantity

CAT: Luminous Flux (Brightness) Bin

HUE: Color Bin

REF: Forward Voltage Bin

LOT No: Lot Number

MADE IN TAIWAN: Production Place



Carrier Tray Specification

Loaded Quantity: 63 PCS Per Tray

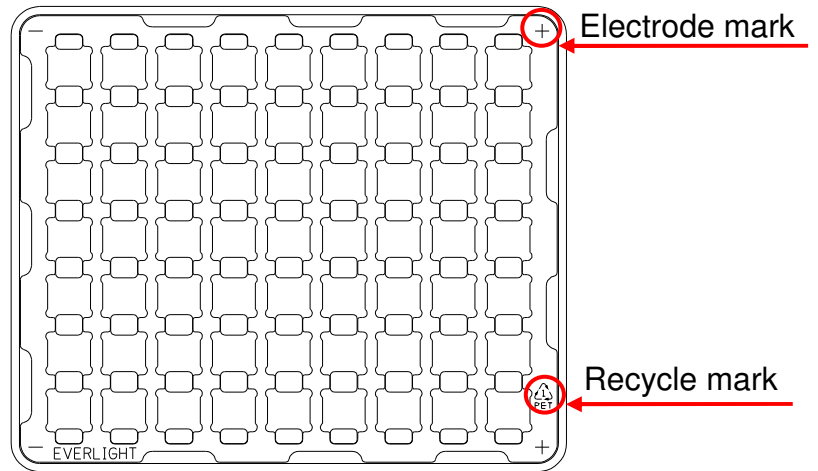
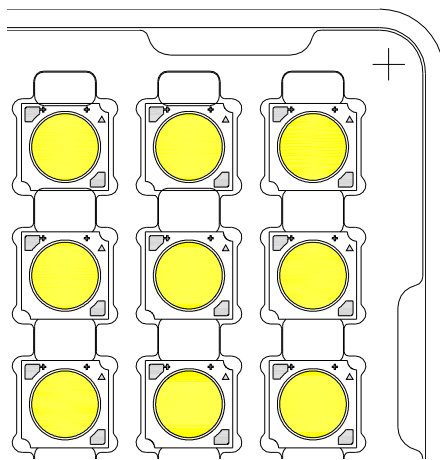

Notes:

1. Dimensions are in millimeters
2. Tolerances unless mentioned are $\pm 0.1\text{mm}$

LED Direction

- The **Recycle mark** on the LEDs will be toward the **Anode mark** on the carrier tray.

Moisture Resistant Packaging



Outside Carton

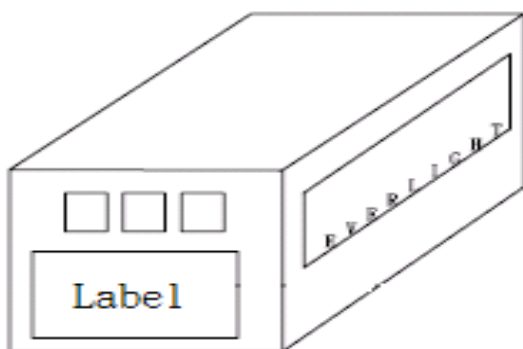

Packaging Quantity

- 63 PCS Per Tray
- 20 Trays Per Outside Carton



Precautions of Use

Over-Current-Proof

- Though the XUAN1919 has a conducted ESD protection mechanism, customers must not use the device in reverse and should apply resistors for extra protection. Otherwise slight voltage shift may cause significant current changes and burn out failure may happen.

Storage Conditions

- Before the package is opened: The LEDs should be stored at 30°C or less and 50%RH or less after being shipped from Everlight and the storage life limit is 6 months. If the LEDs are stored for 6 months or more, they should be stored in a sealed container with a nitrogen atmosphere and moisture absorbent material.
- After opening the package: The LED should be stored under 30°C or less and 30%RH or less. The LED should be used within 168hrs (7days) after opening the package. If unused LEDs remain, it should be stored in moisture proof packages.
- Do not stack assemblies.

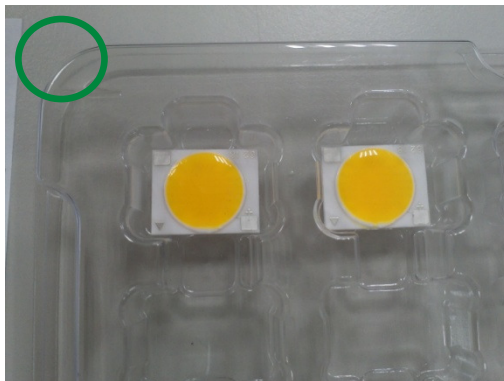

Handling

- Do not put mechanical stress on the LED.
- Never touch the optical surface with finger or sharp object. The LED surface could be soiled or damaged, which could affect the optical performance of the LED.
- In low-humidity work environment, please keep handling the LEDs with appropriate ESD grounding.
- It is recommended to handle the LED with powder-less latex gloves.

Manual Handling

- When handling the product, do not apply direct pressure on the optical surface.
- Do not touch the resin with tweezers to avoid scratching or other damage.

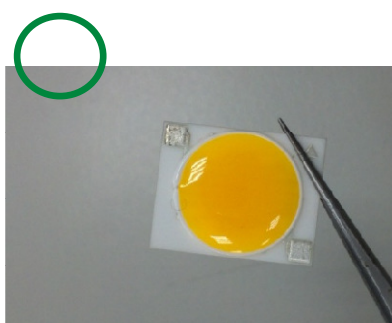

Thermal Management

- Sufficient thermal management must be implemented. Substrate of the positive in temperature must be kept under 85°C at the driving current of 360mA. Otherwise, the junction temperature of die may exceed the limit at high current driving conditions and the LEDs' lifetime may be decrease dramatically.

Revision History

Current version: **2013/12/12**

Previous version: **N/A**

Device No.DHE-0002299

Rev. Ver. 3

Page	Subjects (major change in previous version)	Date of change
5	Add 6500K Bin	2014/04/01