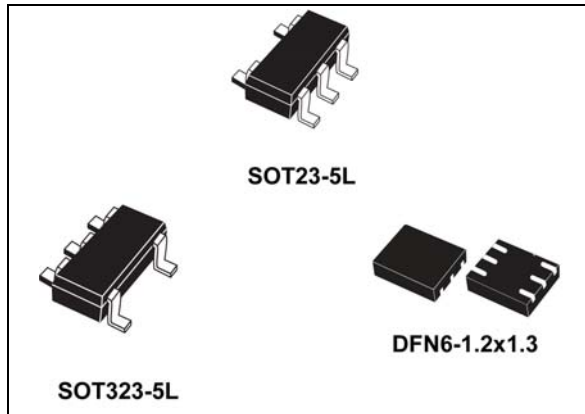

200 mA low quiescent current and low noise LDO

Datasheet - production data

**Features**

- Input voltage from 2.5 to 13.2 V
- Very low-dropout voltage (100 mV typ. @ 100 mA load)
- Low quiescent current (typ. 55 μ A, 1 μ A in off mode)
- Low noise
- Output voltage tolerance: $\pm 2.0\%$ @ 25 $^{\circ}$ C
- 200 mA guaranteed output current
- Wide range of output voltages available on request: fixed from 1.2 V to 12 V with 100 mV step and adjustable
- Logic-controlled electronic shutdown
- Compatible with ceramic capacitor $C_{OUT} = 1 \mu$ F
- Internal current and thermal limit
- Available in SOT23-5L, SOT323-5L and DFN6-1.2x1.3 packages
- Temperature range: -40 $^{\circ}$ C to 125 $^{\circ}$ C

Applications

- Battery-powered equipment
- TV
- Set-top box
- PC and laptop
- Industrial

Description

The LDK220 is a low drop voltage regulator, which provides a maximum output current of 200 mA from an input voltage in the range of 2.5 V to 13.2 V, with a typical dropout voltage of 100 mV.

A ceramic capacitor stabilizes it on the output.

The very low drop voltage, low quiescent current and low noise make it suitable for battery-powered applications.

The enable logic control function puts the LDK220 in shutdown mode allowing a total current consumption lower than 1 μ A.

The device also includes a short-circuit constant current limiting and thermal protection.

Contents

1	Diagram	3
2	Pin configuration	4
3	Typical application	5
4	Maximum ratings	6
5	Electrical characteristics	7
6	Typical characteristics	9
7	Package information	14
	7.1 SOT23-5L package information	14
	7.2 SOT323-5L package information	16
	7.3 DFN6-1.2x1.3 package information	18
8	Ordering information	21
9	Revision history	22

1 Diagram

Figure 1. Block diagram (fixed version)

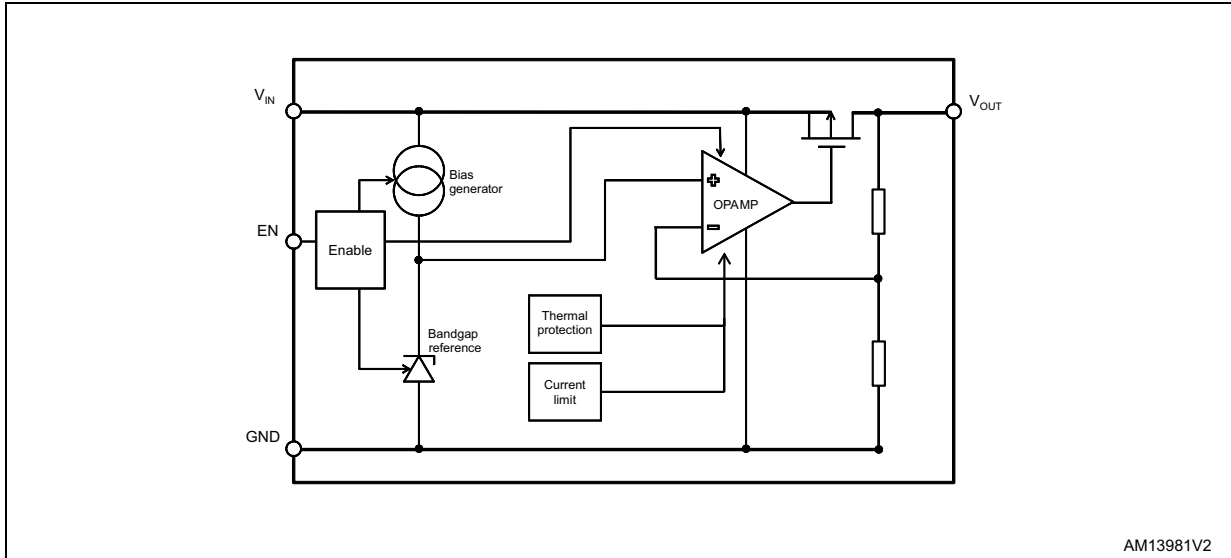
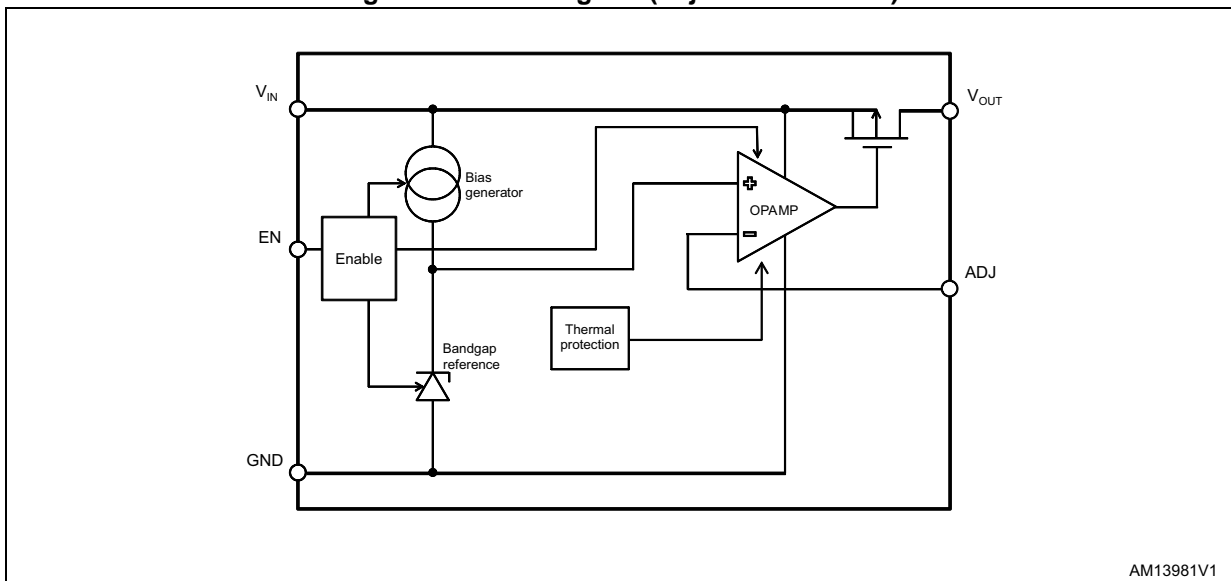

Figure 2. Block diagram (adjustable version)



2 Pin configuration

Figure 3. Pin connection (top view)

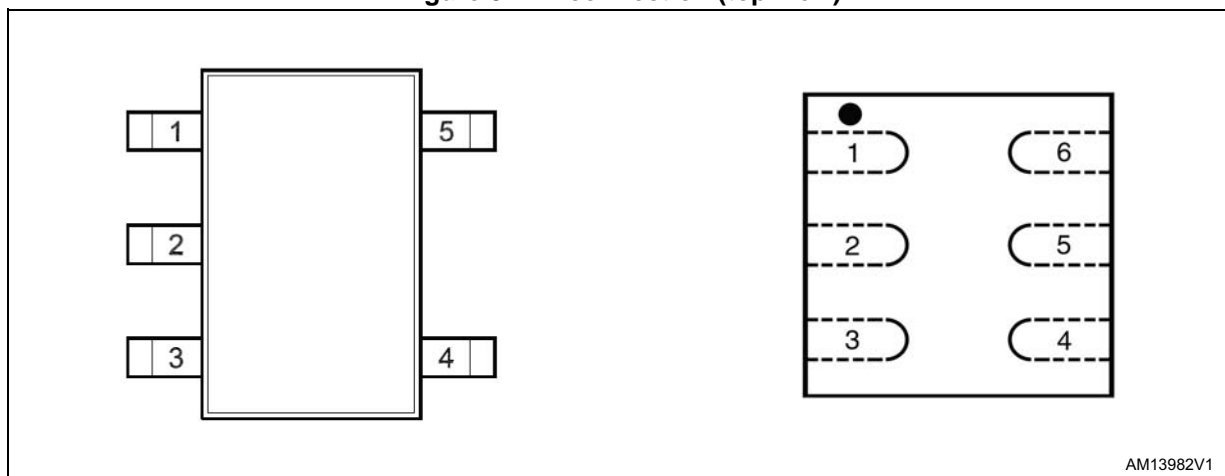

Table 1. Pin description (SOT23-5L, SOT323-5L)

Pin	Symbol	Function
1	IN	Input voltage of the LDO
2	GND	Common ground
3	EN	Enable pin logic input: low = shutdown, high = active
4	ADJ/NC	Adjustable pin on ADJ version, not connected on fixed version
5	OUT	Output voltage of the LDO

Table 2. Pin description (DFN6)

Pin n°	Symbol	Function
1	OUT	Output voltage of the LDO
2	N/C	Not connected
3	ADJ/NC	Adjustable pin on ADJ version, not connected in fixed version
4	EN	Enable pin logic input: low = shutdown, high = active
5	GND	Common ground
6	IN	Input voltage of the LDO

3 Typical application

Figure 4. Typical application circuits

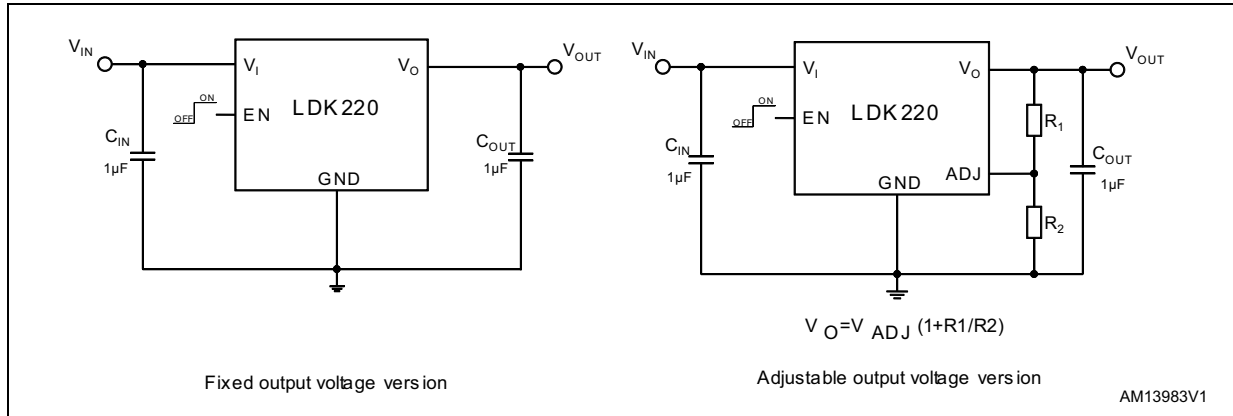

4 Maximum ratings

Table 3. Absolute maximum ratings

Symbol	Parameter	Value	Unit
V_{IN}	DC input voltage	- 0.3 to 14	V
V_{OUT}	DC output voltage	- 0.3 to $V_I + 0.3$	V
V_{EN}	Enable input voltage	- 0.3 to $V_I + 0.3$	V
V_{ADJ}	ADJ pin voltage	- 0.3 to 2	V
I_{OUT}	Output current	Internally limited	mA
$P_D^{(1)}$	Power dissipation	500	mW
T_{STG}	Storage temperature range	- 65 to 150	°C
T_{OP}	Operating junction temperature range	- 40 to 125	°C

1. Maximum power dissipation has to be calculated taking into account the package thermal performance.

Note: Absolute maximum ratings are those values beyond which damage to the device may occur. Functional operation under these conditions is not implied. All values are referred to GND.

Table 4. Thermal data

Symbol	Parameter	SOT23-5L	SOT323-5L	DFN-6	Unit
R_{thJA}	Thermal resistance junction-ambient	160	246	237	°C/W
R_{thJC}	Thermal resistance junction-case	68	134	104	°C/W

5 Electrical characteristics

$T_J = 25\text{ °C}$, $V_{IN} = V_{OUT(NOM)} + 1\text{ V}$, $C_{IN} = C_{OUT} = 1\text{ }\mu\text{F}$, $I_{OUT} = 1\text{ mA}$, $V_{EN} = V_{IN}$, unless otherwise specified.

Table 5. LDK220 electrical characteristics for fixed output version

Symbol	Parameter	Test conditions	Min.	Typ.	Max.	Unit
V_{IN}	Operating input voltage		2.5		13.2	V
V_{OUT}	V_{OUT} accuracy	$I_{OUT} = 1\text{ mA}$, $T_J = 25\text{ °C}$	-2.0		2.0	%
		$I_{OUT} = 1\text{ mA}$, $-40\text{ °C} < T_J < 125\text{ °C}$	-3.0		3.0	%
ΔV_{OUT}	Static line regulation	$V_{OUT} + 1\text{ V} \leq V_{IN} \leq 13.2\text{ V}$, $I_{OUT} = 1\text{ mA}$		0.001	0.05	%/V
ΔV_{OUT}	Static load regulation	$I_{OUT} = 1\text{ mA}$ to 200 mA		0.001	0.003	%/mA
V_{DROP}	Dropout voltage ⁽¹⁾	$I_{OUT} = 100\text{ mA}$, $V_{OUT} = 3.3\text{ V}$		100		mV
		$I_{OUT} = 200\text{ mA}$, $V_{OUT} = 3.3\text{ V}$ $40\text{ °C} < T_J < 125\text{ °C}$		200	350	
e_N	Output noise voltage	10 Hz to 100 kHz, $I_{OUT} = 10\text{ mA}$		20		$\mu\text{V}_{RMS}/\text{V}$
SVR	Supply voltage rejection	$V_{IN} = V_{OUTNOM} + 0.5\text{ V} + /-V_{RIPPLE}$ $V_{RIPPLE} = 0.1\text{ V}$ frequency = 120 Hz to 1 kHz $I_{OUT} = 10\text{ mA}$		55		dB
		$V_{IN} = V_{OUTNOM} + 0.5\text{ V} + /-V_{RIPPLE}$ $V_{RIPPLE} = 0.1\text{ V}$ frequency = 10 kHz $I_{OUT} = 10\text{ mA}$		50		
I_Q	Quiescent current	$V_{IN} = V_{OUT} + 1\text{ V}$ $I_{OUT} = 0\text{ mA}$, $-40\text{ °C} < T_J < 125\text{ °C}$		55	90	μA
		$V_{OUT} + 1\text{ V} \leq V_{IN} \leq 13.2\text{ V}$ ⁽²⁾ $I_{OUT} = 200\text{ mA}$, $-40\text{ °C} < T_J < 125\text{ °C}$		60	100	
		V_{IN} input current in off mode: $V_{EN} = \text{GND}$, $T_J = 25\text{ °C}$		0.1	1	
I_{SC}	Short-circuit current ⁽²⁾	$R_L = 0$		400		mA
V_{EN}	Enable input logic low	$V_{IN} = 2.5\text{ V}$ to 13.2 V, $-40\text{ °C} < T_J < 125\text{ °C}$			0.4	V
	Enable input logic high	$V_{IN} = 2.5\text{ V}$ to 13.2 V, $-40\text{ °C} < T_J < 125\text{ °C}$	1.2			
I_{EN}	Enable pin input current	$V_{EN} = V_{IN}$		0.1	100	nA
T_{SHDN}	Thermal shutdown			160		°C
	Hysteresis			20		
C_{OUT}	Output capacitor	Capacitance (see Section 6: Typical characteristics)	1		22	μF

1. Dropout voltage is the input-to-output voltage difference at which the output voltage is 100 mV below its nominal value.
2. The maximum current has to be limited according to the maximum power dissipation.

$T_J = 25\text{ °C}$, $V_{IN} = V_{OUT(NOM)} + 1\text{ V}$, $C_{IN} = C_{OUT} = 1\text{ }\mu\text{F}$, $I_{OUT} = 1\text{ mA}$, $V_{EN} = V_{IN}$, unless otherwise specified.

Table 6. LDK220 electrical characteristics for adjustable version

Symbol	Parameter	Test conditions	Min.	Typ.	Max.	Unit
V_{IN}	Operating input voltage		2.5		13.2	V
V_{ADJ}	V_{ADJ} accuracy	$I_{OUT} = 1\text{ mA}$, $T_J = 25\text{ °C}$	-2%	1.19	+2%	mV
		$I_{OUT} = 1\text{ mA}$, $-40\text{ °C} < T_J < 125\text{ °C}$	-3.0	1.185	3.0	%
ΔV_{OUT}	Static line regulation	$V_{OUT} + 1\text{ V} \leq V_{IN} \leq 13.2\text{ V}$, $I_{OUT} = 1\text{ mA}$		0.001	0.05	%/V
ΔV_{OUT}	Static load regulation	$I_{OUT} = 1\text{ mA}$ to 200 mA		0.0002	0.003	%/mA
V_{DROP}	Dropout voltage ⁽¹⁾	$I_{OUT} = 100\text{ mA}$, $V_{OUT} = 3.3\text{ V}$		100		mV
		$I_{OUT} = 200\text{ mA}$, $V_{OUT} = 3.3\text{ V}$ $40\text{ °C} < T_J < 125\text{ °C}$,		200	350	
e_N	Output noise voltage	10 Hz to 100 kHz, $I_{OUT} = 10\text{ mA}$		100		$\mu\text{V}_{RMS}/\sqrt{\text{V}}$
I_{ADJ}	Adjust pin current				1	μA
SVR	Supply voltage rejection	$V_{IN} = V_{OUTNOM} + 0.5\text{ V} + /-V_{RIPPLE}$ $V_{RIPPLE} = 0.1\text{ V}$ frequency=120 Hz to 1 kHz $I_{OUT} = 10\text{ mA}$		60		dB
		$V_{IN} = V_{OUTNOM} + 0.5\text{ V} + /-V_{RIPPLE}$ $V_{RIPPLE} = 0.1\text{ V}$ frequency=10 kHz $I_{OUT} = 10\text{ mA}$		45		
I_Q	Quiescent current	$V_{OUT} + 1\text{ V} \leq V_{IN} \leq 13.2\text{ V}$ $I_{OUT} = 0\text{ mA}$, $-40\text{ °C} < T_J < 125\text{ °C}$		55	90	μA
		$V_{OUT} + 1\text{ V} \leq V_{IN} \leq 13.2\text{ V}^{(2)}$ $I_{OUT} = 200\text{ mA}$, $-40\text{ °C} < T_J < 125\text{ °C}$		60	100	
		V_{IN} input current in off mode: $V_{EN} = \text{GND}$, $T_J = 25\text{ °C}$		0.1	1	
I_{SC}	Short-circuit current ⁽²⁾	$R_L = 0$		400		mA
V_{EN}	Enable input logic low	$V_{IN} = 2.5\text{ V}$ to 13.2 V, $-40\text{ °C} < T_J < 125\text{ °C}$			0.4	V
	Enable input logic high	$V_{IN} = 2.5\text{ V}$ to 13.2 V, $-40\text{ °C} < T_J < 125\text{ °C}$	1.2			
I_{EN}	Enable pin input current	$V_{EN} = V_{IN}$		0.1	100	nA
T_{SHDN}	Thermal shutdown			160		°C
	Hysteresis			20		
C_{OUT}	Output capacitor	Capacitance (see Section 6: Typical characteristics)	1		22	μF

- Dropout voltage is the input-to-output voltage difference at which the output voltage is 100 mV below its nominal value.
- The maximum current has to be limited according to the maximum power dissipation.

6 Typical characteristics

($C_{IN} = C_{OUT} = 1 \mu F$, V_{EN} to V_{IN})

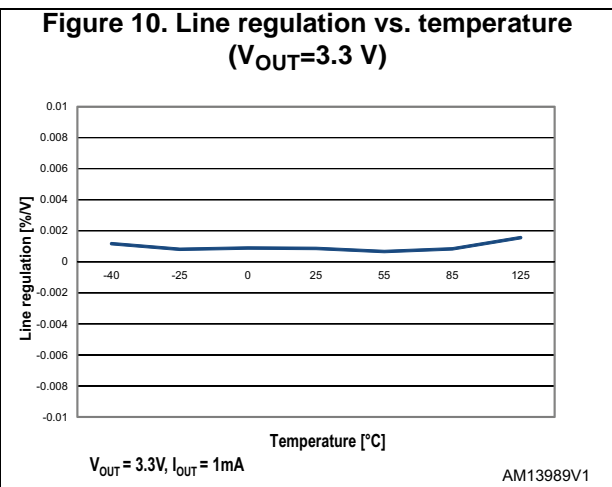
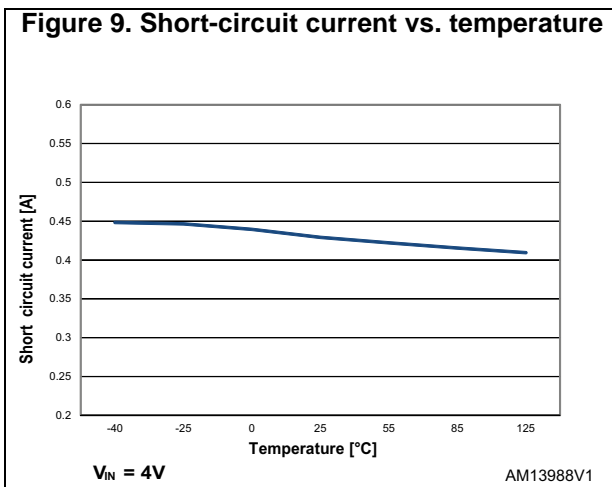
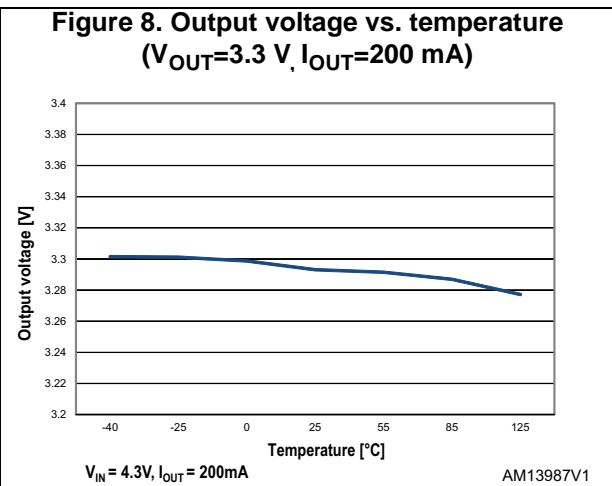
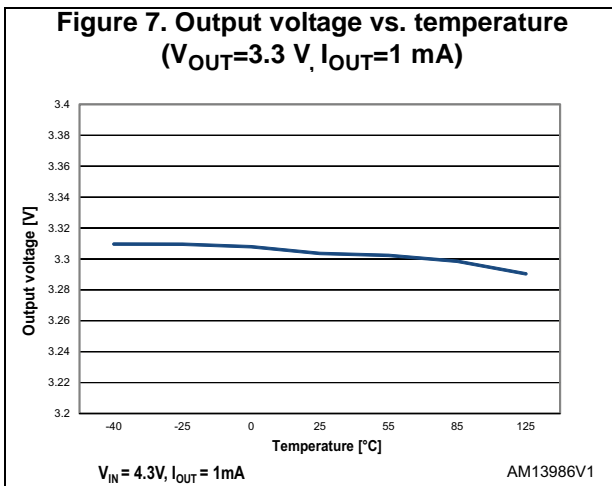
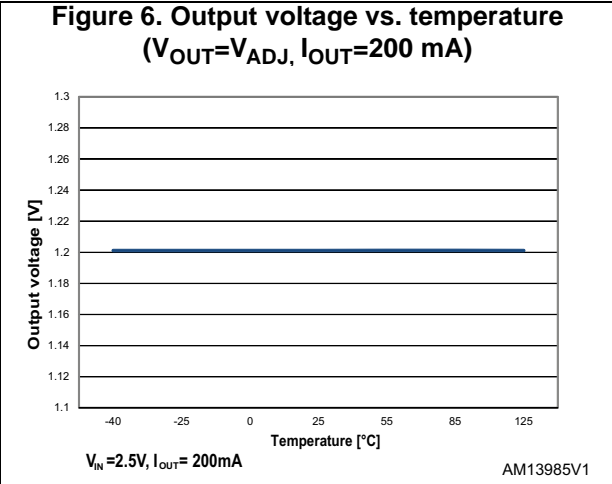
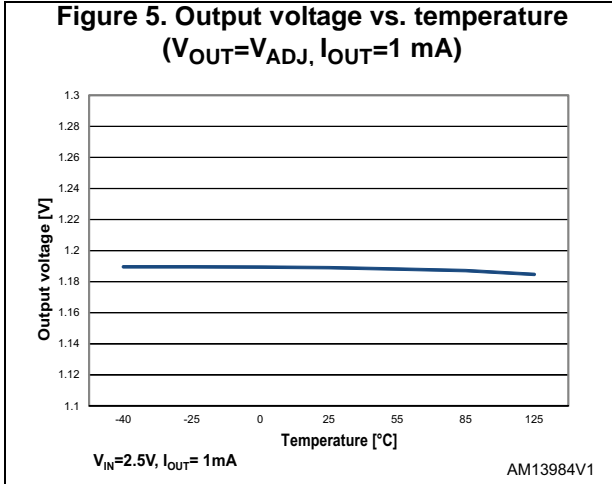

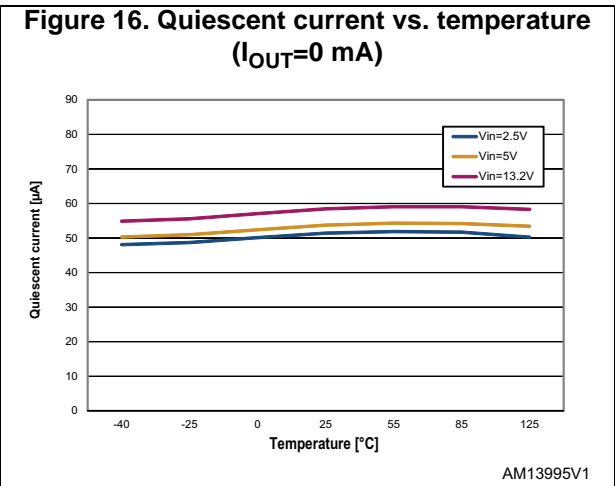
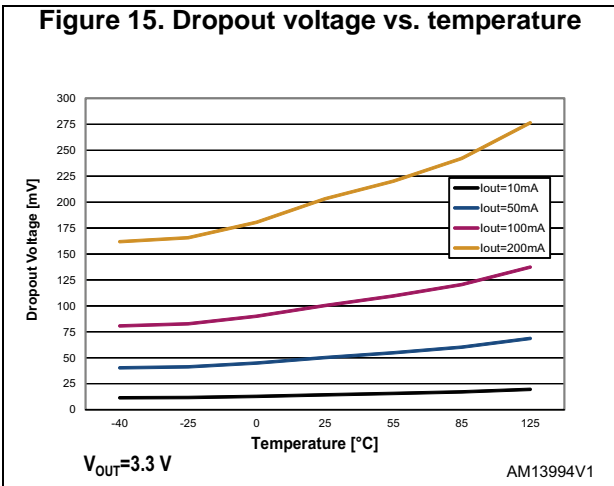
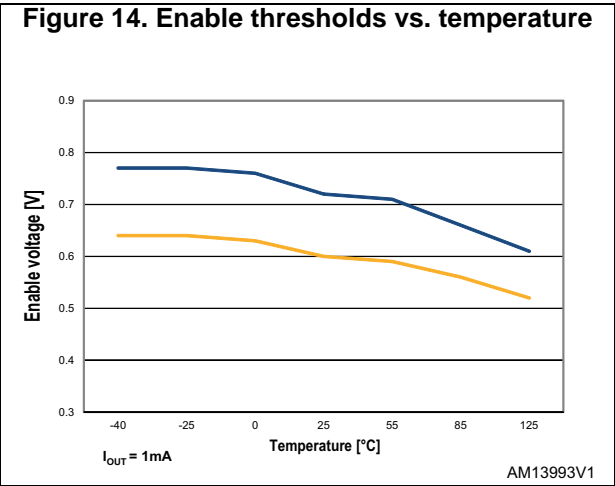
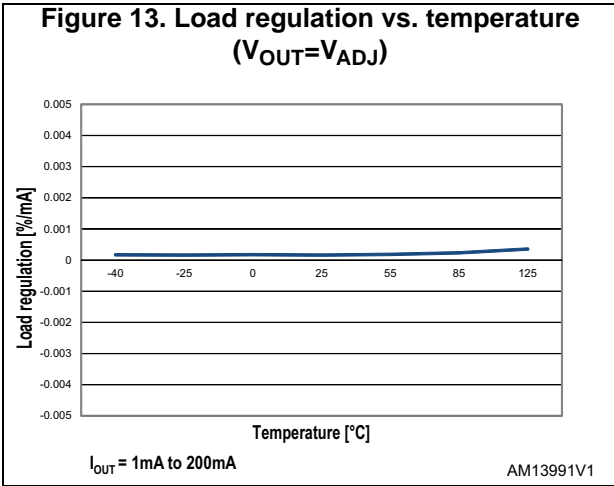
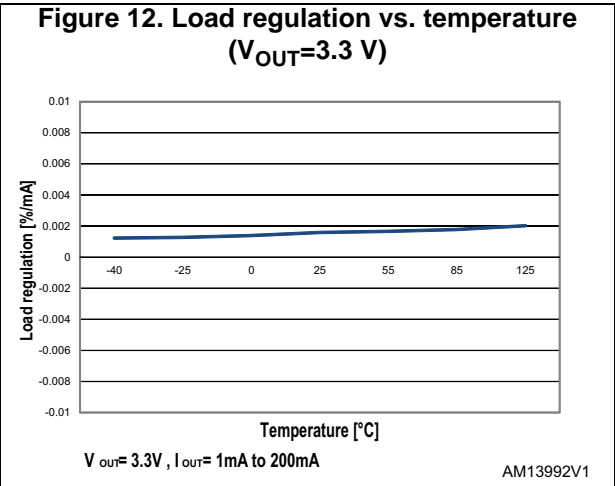
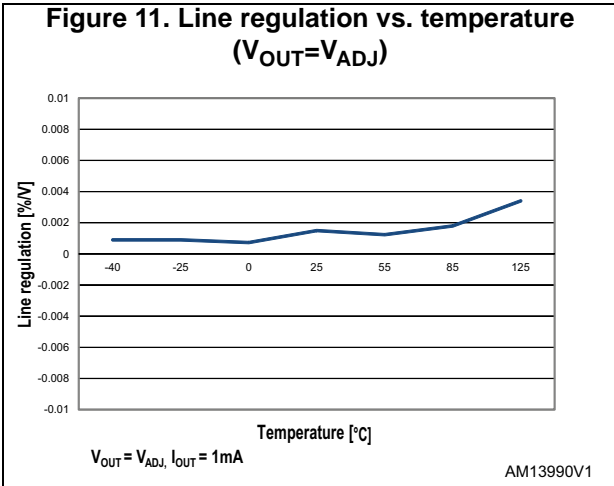
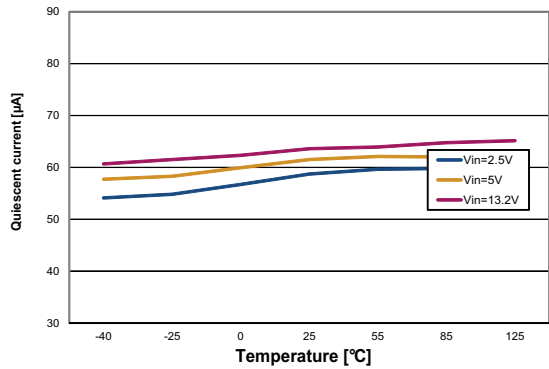
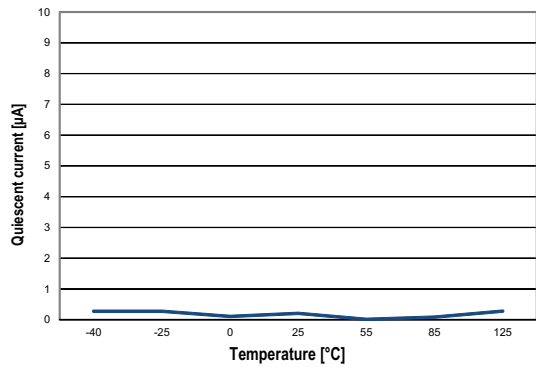

Figure 17. Quiescent current vs. temperature ($I_{OUT}=200\text{ mA}$)



AM13996V1

Figure 18. Off-state current vs. temperature



AM13997V1

Figure 19. SVR vs. frequency ($V_{OUT}=3.3\text{ V}$)

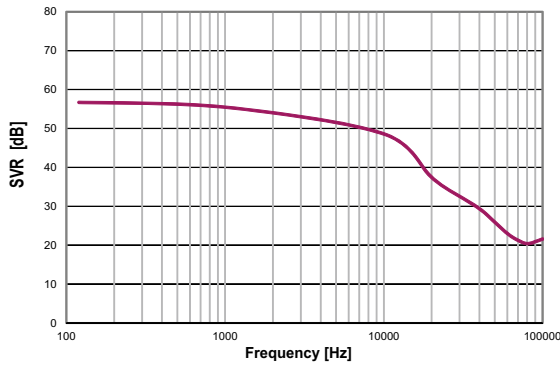

$V_{IN}=3.7\text{ V} \pm 100\text{ mV}$, $V_{OUT}=3.3\text{ V}$, $C_{OUT}=1\mu\text{F}$

AM13998V1

Figure 20. SVR vs. frequency ($V_{OUT}=V_{ADJ}$)

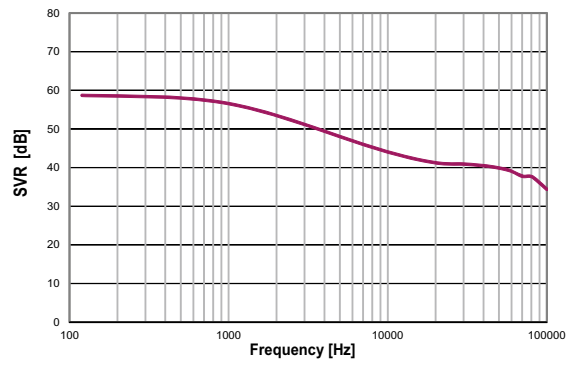

$V_{IN}=2.5\text{ V} \pm 100\text{ mV}$, $V_{OUT}=V_{ADJ}$, $C_{OUT}=1\mu\text{F}$

AM13999V1

Figure 21. Output noise spectral density

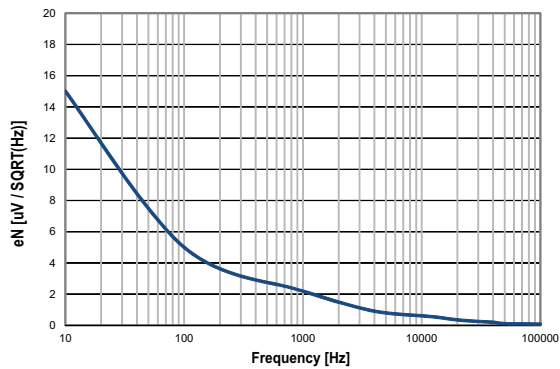

$V_{OUT}=3.3\text{ V}$, $C_{IN}=C_{OUT}=1\mu\text{F}$

AM14000V1

Figure 22. Stability vs. (C_{OUT} , ESR)

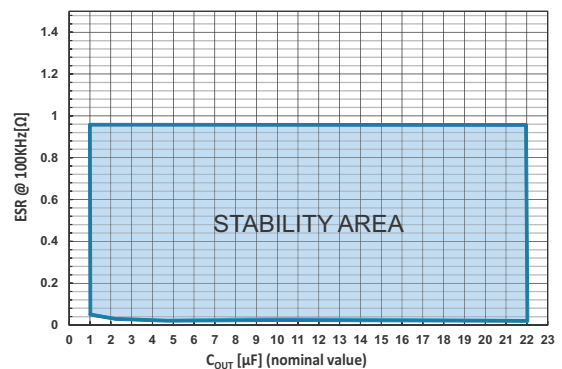

V_{IN} from 2.5 to 13.2V, I_{OUT} from 0 to 200mA, $C_{IN}=1\mu\text{F}$ AM14001V1

Figure 23. Startup with enable ($V_{OUT}=3.3\text{ V}$)

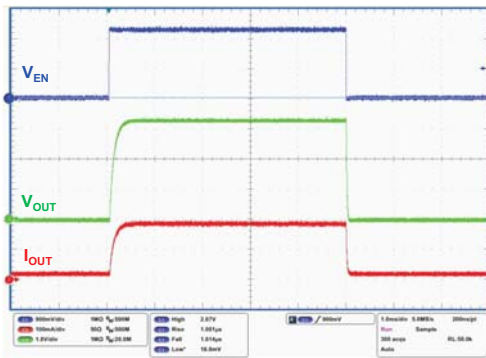

$V_{IN}=4.3\text{V}$, $V_{EN}=0\text{V to }2\text{V}$, $I_{OUT}=0.2\text{A}$, $V_{OUT}=3.3\text{V}$, $T_r=T_f=1\mu\text{s}$

AM14002V1

Figure 24. Startup with enable ($V_{OUT}=V_{ADJ}$)

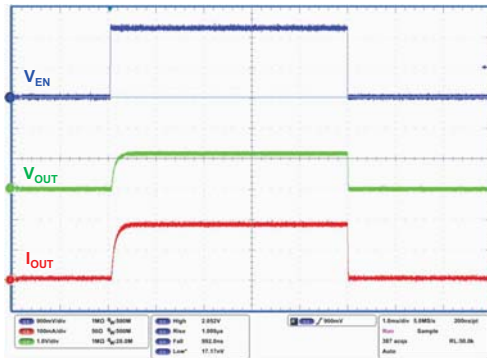

$V_{IN}=2.5\text{V}$, $V_{EN}=0\text{V to }V_{IN}$, $I_{OUT}=0.2\text{A}$, $V_{OUT}=V_{ADJ}$, $T_r=T_f=1\mu\text{s}$

AM14003V1

Figure 25. Turn-on time ($V_{OUT}=3.3\text{ V}$)

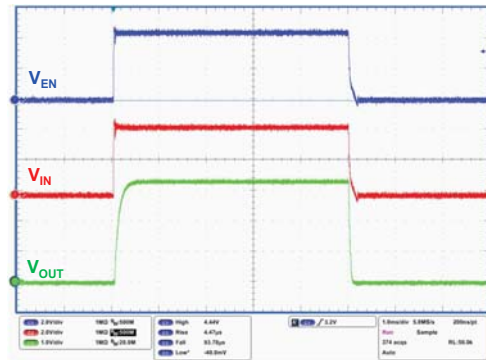

$V_{IN}=V_{EN}=0\text{V to }4.3\text{V}$, $I_{OUT}=0.2\text{A}$, $V_{OUT}=3.3\text{V}$, $T_r=5\mu\text{s}$

AM14004V1

Figure 26. Turn-on time ($V_{OUT}=V_{ADJ}$)

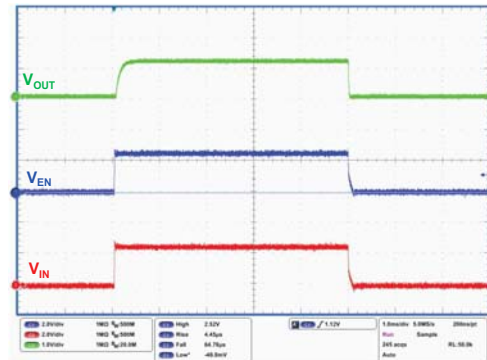

$V_{IN}=V_{EN}=0\text{V to }2.5\text{V}$, $I_{OUT}=0.2\text{A}$, $V_{OUT}=V_{ADJ}$, $T_r=5\mu\text{s}$

AM14005V1

Figure 27. Line transient ($V_{OUT}=3.3\text{ V}$)

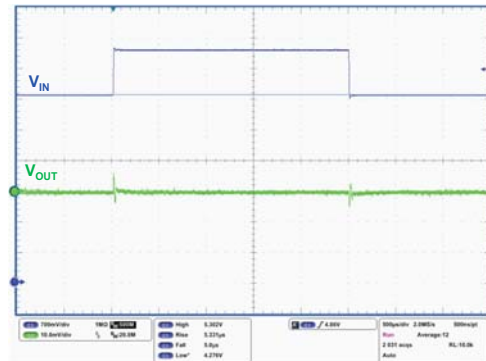

$V_{IN}=V_{EN}=4.3\text{V to }5.3\text{V}$, $I_{OUT}=1\text{mA}$, $V_{OUT}=3.3\text{V}$, $T_r=T_f=5\mu\text{s}$

AM14006V1

Figure 28. Line transient ($V_{OUT}=V_{ADJ}$)

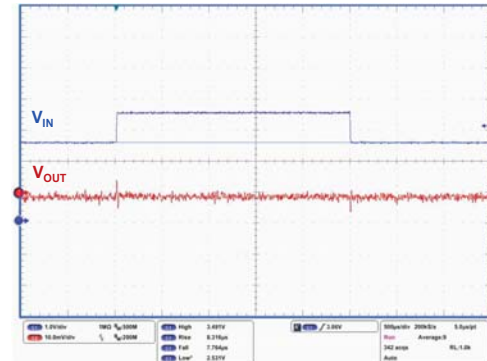

$V_{IN}=V_{EN}=2.5\text{V to }3.5\text{V}$, $I_{OUT}=1\text{mA}$, $V_{OUT}=V_{ADJ}$, $T_r=T_f=5\mu\text{s}$

AM14007V1

Figure 29. Load transient ($V_{OUT}=3.3\text{ V}$)

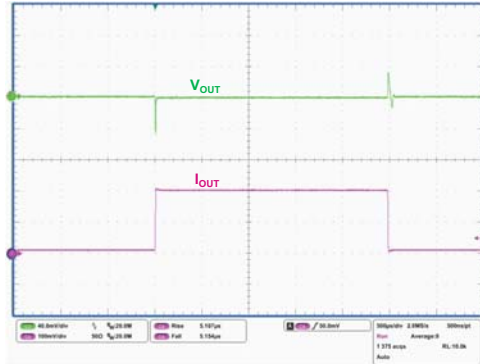

$V_{IN} = V_{EN} = 4.3\text{ V}$, $I_{OUT} = 1\text{ mA}$ to 0.2 A , $V_{OUT} = 3.3\text{ V}$, $T_r = T_f = 5\mu\text{s}$

AM14008V1

Figure 30. Load transient ($V_{OUT}=V_{ADJ}$)

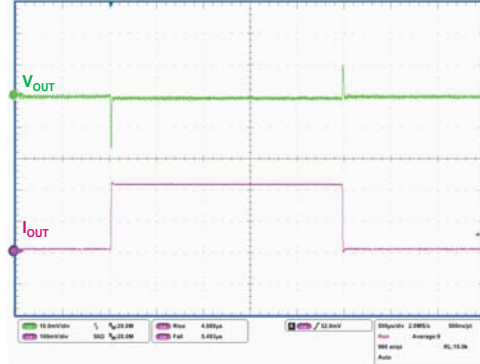

$V_{IN} = V_{EN} = 2.5\text{ V}$, $I_{OUT} = 1\text{ mA}$ to 0.2 A , $V_{OUT} = V_{ADJ}$, $T_r = T_f = 5\mu\text{s}$

AM14009V1

7 Package information

In order to meet environmental requirements, ST offers these devices in different grades of ECOPACK® packages, depending on their level of environmental compliance. ECOPACK® specifications, grade definitions and product status are available at: www.st.com. ECOPACK® is an ST trademark.

7.1 SOT23-5L package information

Figure 31. SOT23-5L package outline

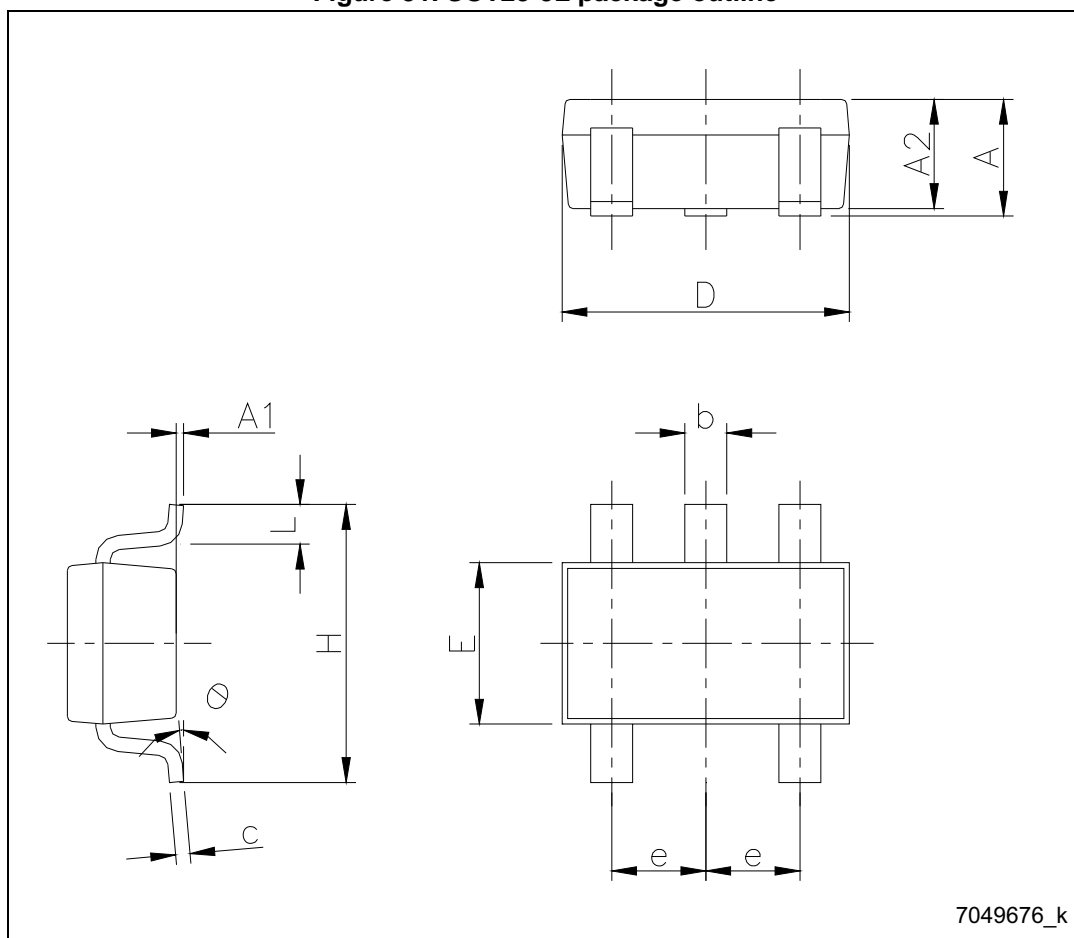
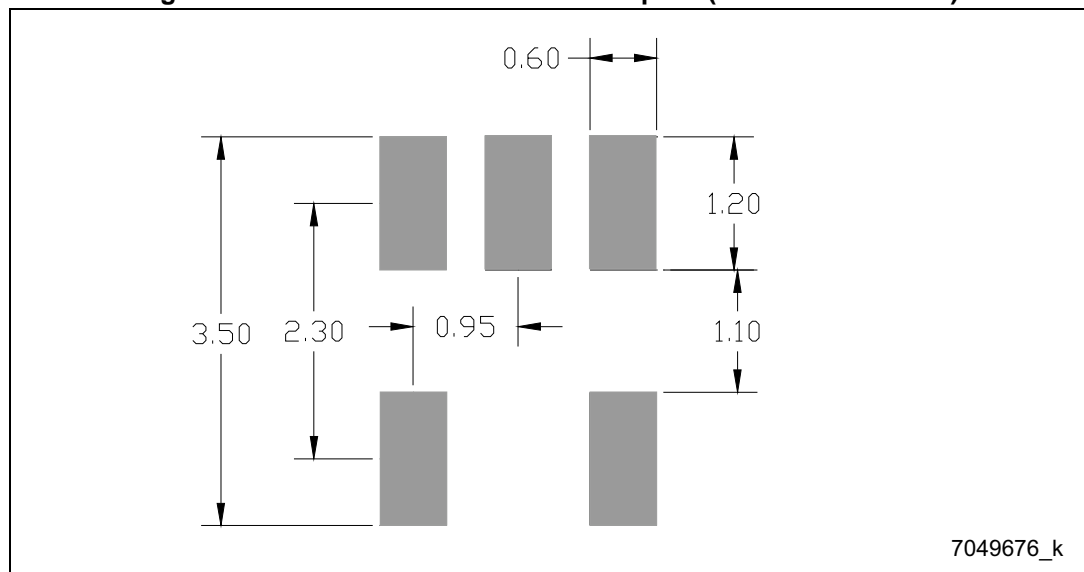

Table 7. SOT23-5L mechanical data

Dim.	mm		
	Min.	Typ.	Max.
A	0.90		1.45
A1	0		0.15
A2	0.90		1.30
b	0.30		0.50
c	0.09		0.20
D		2.95	
E		1.60	
e		0.95	
H		2.80	
L	0.30		0.60
θ	0		8

Figure 32. SOT23-5L recommended footprint (dimensions in mm)



7.2 SOT323-5L package information

Figure 33. SOT323-5L package outline

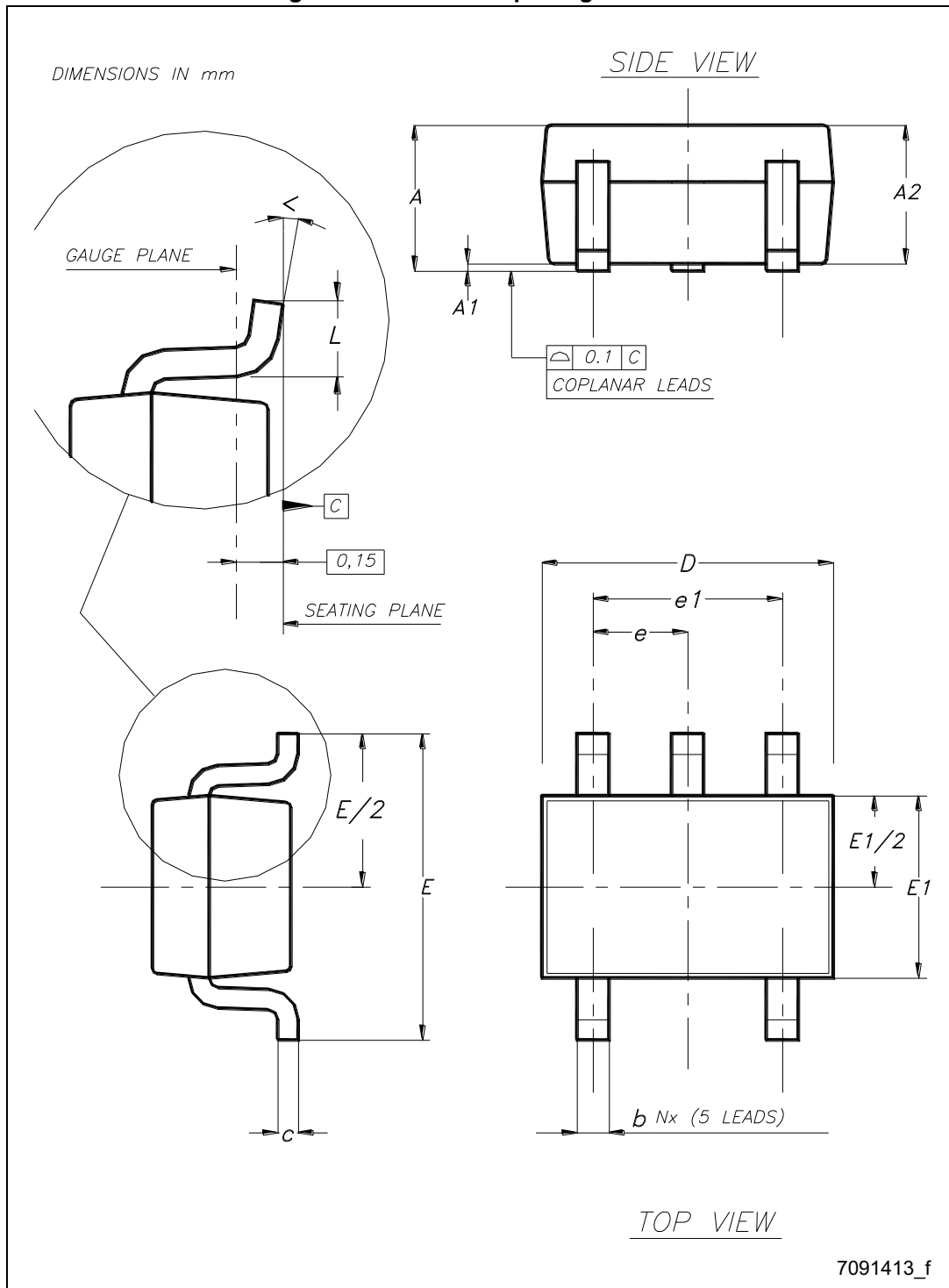

Table 8. SOT323-5L mechanical data

Dim.	mm		
	Min.	Typ.	Max.
A	0.80		1.10
A1	0		0.10
A2	0.80	0.90	1
b	0.15		0.30
c	0.10		0.22
D	1.80	2	2.20
E	1.80	2.10	2.40
E1	1.15	1.25	1.35
e		0.65	
e1		1.30	
L	0.26	0.36	0.46
<	0°		8°

7.3 DFN6-1.2x1.3 package information

Figure 34. DFN6-1.2x1.3 drawings

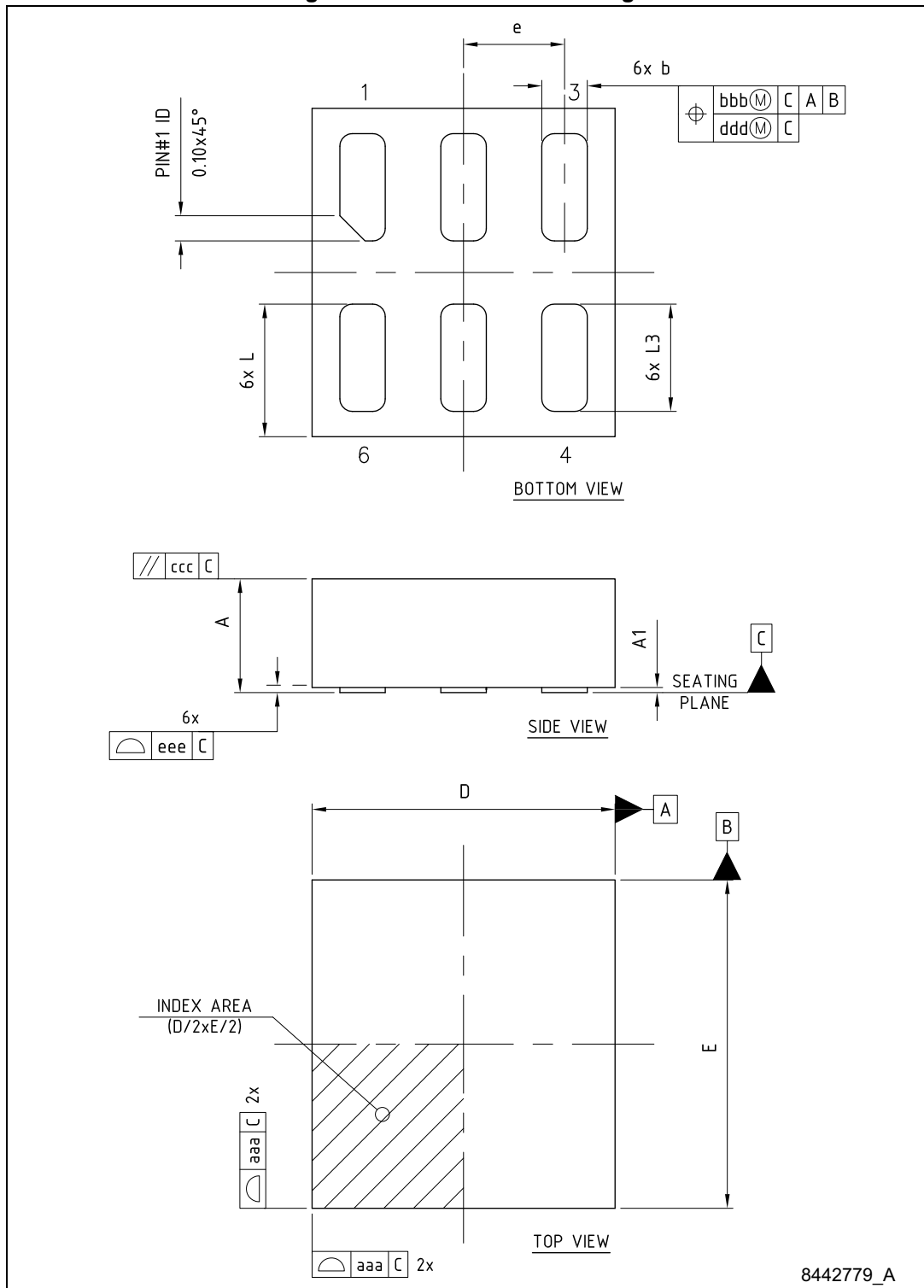
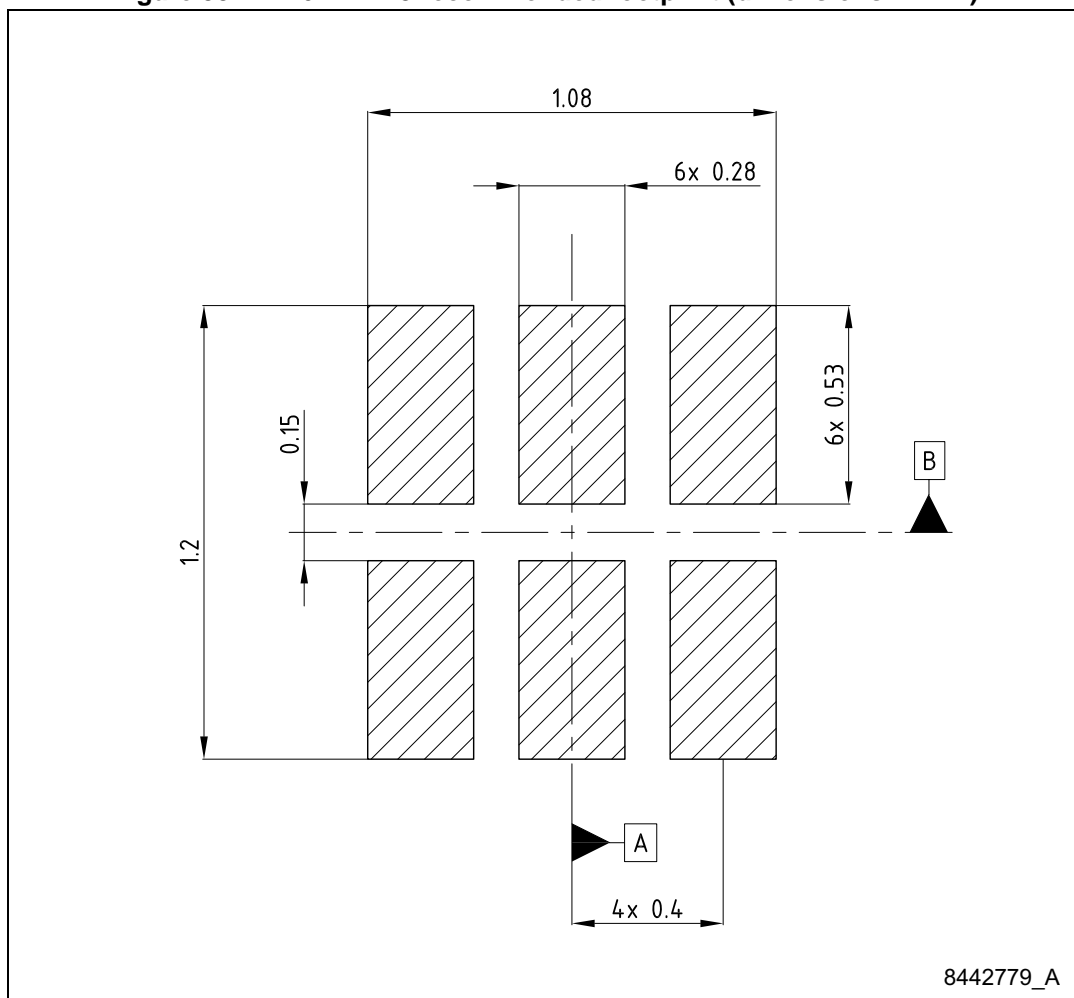

Table 9. DFN6-1.2x1.3 mechanical data

Dim.	mm		
	Min.	Typ.	Max.
A	0.41	0.45	0.50
A1	0.00	0.02	0.05
D	-	1.20	-
E	-	1.30	-
e	-	0.40	-
b	0.15	0.18	0.25
L	0.475	0.525	0.575
L3	0.375	0.425	0.475
aaa	-	0.05	-
bbb	-	0.10	-
ccc	-	0.05	-
ddd	-	0.05	-
eee	-	0.05	-

Figure 35. DFN6-1.2x1.3 recommended footprint (dimensions in mm)



8 Ordering information

Table 10. Order codes

SOT323-5L	SOT23-5L	DFN6	Output voltage (V)
LDK220C12R	LDK220M12R	LDK220PU12R	1.2
LDK220C13R	LDK220M13R	LDK220PU13R	1.3
LDK220C15R	LDK220M15R	LDK220PU15R	1.5
LDK220C18R	LDK220M18R	LDK220PU18R	1.8
LDK220C25R	LDK220M25R	LDK220PU25R	2.5
LDK220C27R	LDK220M27R	LDK220PU27R	2.7
LDK220C28R	LDK220M28R	LDK220PU28R	2.8
LDK220C30R	LDK220M30R	LDK220PU30R	3
LDK220C31R	LDK220M31R	LDK220PU31R	3.1
LDK220C32R	LDK220M32R	LDK220PU32R	3.2
LDK220C33R	LDK220M33R	LDK220PU33R	3.3
LDK220C36R	LDK220M36R	LDK220PU36R	3.6
LDK220C40R	LDK220M40R	LDK220PU40R	4
LDK220C42R	LDK220M42R	LDK220PU42R	4.2
LDK220C50R	LDK220M50R	LDK220PU50R	5
LDK220C60R	LDK220M60R	LDK220PU60R	6
LDK220C85R	LDK220M85R	LDK220PU85R	8.5
LDK220C90R	LDK220M90R	LDK220PU90R	9
LDK220C-R	LDK220M-R	LDK220PU-R	adj

9 Revision history

Table 11. Document revision history

Date	Revision	Changes
19-Mar-2014	1	Initial release.
24-Nov-2014	2	Updated the features in cover page, Table 5: LDK220 electrical characteristics for fixed output version , Table 6: LDK220 electrical characteristics for adjustable version , Table 7: SOT23-5L mechanical data , and Section 6: Typical characteristics . Minor text changes.

IMPORTANT NOTICE – PLEASE READ CAREFULLY

STMicroelectronics NV and its subsidiaries ("ST") reserve the right to make changes, corrections, enhancements, modifications, and improvements to ST products and/or to this document at any time without notice. Purchasers should obtain the latest relevant information on ST products before placing orders. ST products are sold pursuant to ST's terms and conditions of sale in place at the time of order acknowledgement.

Purchasers are solely responsible for the choice, selection, and use of ST products and ST assumes no liability for application assistance or the design of Purchasers' products.

No license, express or implied, to any intellectual property right is granted by ST herein.

Resale of ST products with provisions different from the information set forth herein shall void any warranty granted by ST for such product.

ST and the ST logo are trademarks of ST. All other product or service names are the property of their respective owners.

Information in this document supersedes and replaces information previously supplied in any prior versions of this document.

© 2014 STMicroelectronics – All rights reserved