

Verpackt im Gurt nach DIN IEC 60286-3  
 Tape on Reel Packaging according to DIN IEC 60286-3  
 Verpackungseinheit: 280 Stück  
 Packaging unit: 280 pcs

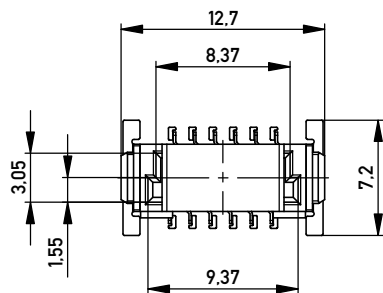

ohne Ansaughaube - without hood

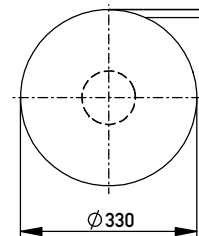
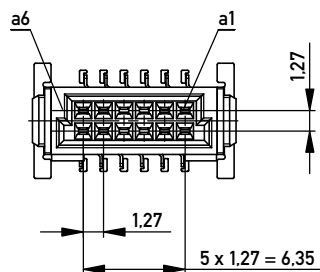

Abspulrichtung - Reel off Direction

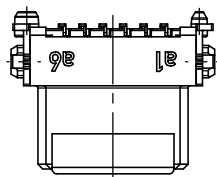
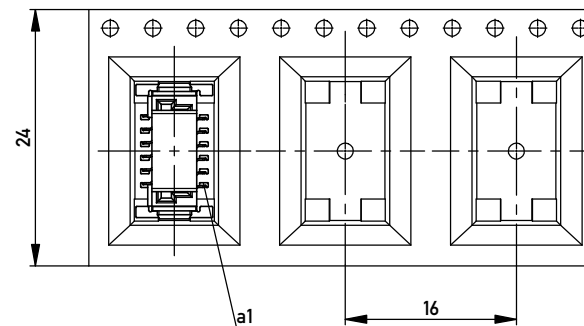

Leiterplatten-Layout Vorschlag für SMT  
 PCB-Layout Proposal for SMT

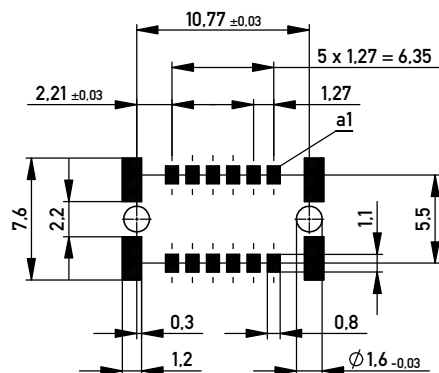

Anforderungsstufe 1  
 Performance Level 1



Kontaktbereich vergoldet  
 Mating Area gold plating

Anschlussbereich verzinkt 4-6 µm  
 Terminal Area 4-6 µm tin plating

Koplanarität der Anschlüsse ≤ 0,1 mm  
 Coplanarity Area of Termination ≤ 0,1 mm

BA 7-03 - Standard Bauhöhe

type 7-03 - standard assembly height

|  |            |   |   |   |     |
|--|------------|---|---|---|-----|
| Information:   |            | Tolerances  |  | Scale   | 3:1 |
| All rights reserved.<br>Only for Information.<br>To ensure that this is the latest version of this drawing, please contact one of the ERNI companies before using. |            | All Dimensions in mm  |   | Designation   |     |
| Subject to modification without prior notice.<br>Drawing will not be updated.  |            |  |   | Federl. SMC-B 12-SMD-BA7-03<br>Female SMC-B 12-SMD-type7-03 |     |
| e  | 04.12.2013 | www.ERNI.com  |   | 100100160003  |     |
| Index  | Date       |   |   | K<br>A3   |     |
|  |            |   |   | Class SMCB  |     |

Copyright by ERNI GmbH  
 Proprietary notice pursuant to ISO 16018 to be observed.