



Single Clock Generator

AK8118

Features

- **Output Frequency Range:**
40.5MHz / 32.0MHz (Selectable)
- **Input Frequency:**
27MHz
- **Low Jitter Performance:**
15 ps (Typ.) Period, 1 σ
- **Low Current Consumption:**
3.5mA (Typ.)
- **Output Load:**
15pF (max.)
- **Supply Voltage:**
2.7 – 3.6V
- **Operating Temperature Range:**
-20 to +85°C
- **Package:**
6-pin SON (lead-free)
Body Size 2.6mm x 1.6mm

Description

The AK8118 is a single clock generator IC with an integrated PLL. It can generate either a 40.5MHz or a 32.0MHz clock from a 27MHz master clock input frequency. Through pin control, the output can be enabled or disabled, the frequency can be changed, and the device can be placed in a power-down mode. A high performance PLL locks to the master clock input, generating a low jitter, highly accurate clock output without an external crystal.

Applications

- Digital Still Camera

Block Diagram

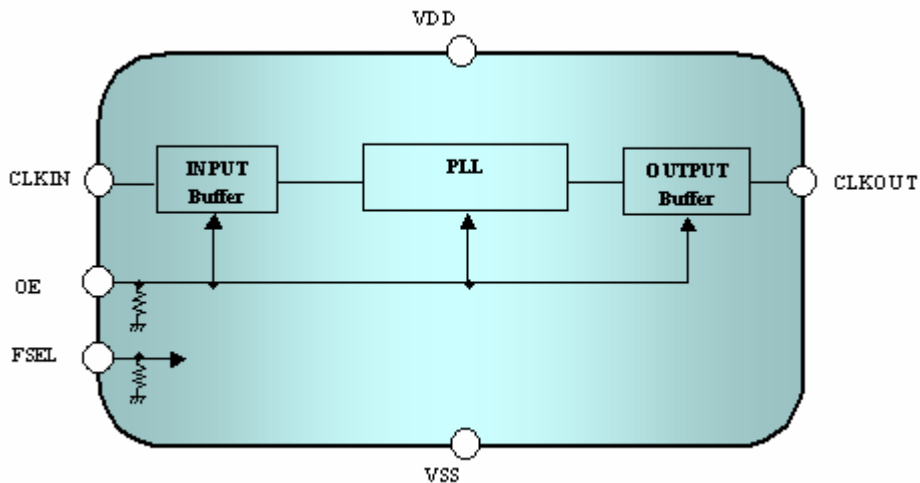

AK8118 Single Clock Generator

Pin Descriptions

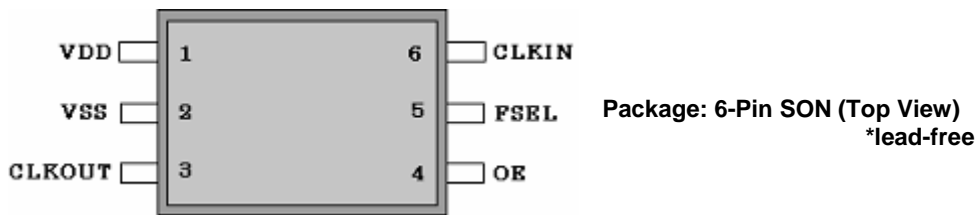

Pin No.	Pin Name	Pin Type	Description
1	VDD	--	Power Supply
2	VSS	--	Ground
3	CLKOUT	OUT	Clock output Output clock frequency is selectable to 40.5MHz or 32.0MHz by setting the FSEL pin. In power down mode (OE = "L"), this pin is "L".
4	OE	IN	CLKOUT output enable control (1) "L": CLKOUT="L" and power down. "H": active
5	FSEL	IN	Clock frequency select (1) "L": 40.5MHz, "H": 32.0MHz
6	CLKIN	IN	Clock input (27MHz) Place the AK8118 in power down (OE = "L") mode when an input clock is not supplied. Unstable input to the CLKIN causes the unstable CLKOUT signal. DC input to the CLKIN also causes the unstable CLKOUT signal.

(1) Internal pull down 100kΩ (Typ.)

Ordering Information

Part Number	Marking	Shipping Packaging	Package	Temperature Range
AK8118L	118(AK8118)	Tape and Reel	6-pin SON	-20 to 85 °C

Absolute Maximum Rating

Over operating free-air temperature range unless otherwise noted ⁽¹⁾

Items	Symbol	Ratings	Unit
Supply Voltage	VDD	-0.3 to 4.6	V
Input Voltage	V _{in}	VSS-0.3 to VDD+0.3	V
Input Current (any pins except supplies)	I _{IN}	± 10	mA
Storage Temperature	T _{stg}	-55 to 130	°C

Note

(1) Stress beyond those listed under “Absolute Maximum Ratings” may cause permanent damage to the device. These are stress ratings only. Functional operation of the device at these or any other conditions beyond those indicated under “Recommended Operating Conditions” is not implied. Exposure to absolute-maximum-rating conditions for extended periods may affect device reliability. Electrical parameters are guaranteed only over the recommended operating temperature range.



ESD Sensitive Device

This device is manufactured on a CMOS process, therefore, generically susceptible to damage by excessive static voltage. Failure to observe proper handling and installation procedures can cause damage. AKEMD recommends that this device is handled with appropriate precautions.

Recommended Operation Conditions

Parameter	Symbol	Conditions	Min	Typ	Max	Unit
Operating Temperature	T _a		-20		85	°C
Supply Voltage	VDD		2.7	3.0	3.6	V
Input Clock Frequency	F _{in}			27		MHz
Input Clock Duty Cycle				50		%
Output Load Capacitance	C _{p1}	Pin: CLKOUT			15	pF

DC Characteristics

All specifications at VDD: over 2.7 to 3.6V, Ta: -20 to +85°C, Input Frequency: 27MHz,
unless otherwise noted

Parameter	Symbol	Conditions	MIN	TYP	MAX	Unit
High Level Input Voltage	V _{IH}	Pin: CLKIN, FSEL, OE	0.8VDD			V
Low Level Input Voltage	V _{IL}	Pin: CLKIN, FSEL, OE			0.2VDD	V
Input Current 1	I _{L1}	Pin: CLKIN	-10		+10	μA
Input Current 2	I _{L2}	Pin: OE, FSEL	-10		+75	μA
High Level Output Voltage	V _{OH}	Pin: CLKOUT I _{OH} =-4mA (VDD=3.0V, Ta=25°C)	0.8VDD			V
Low Level Output Voltage	V _{OL}	Pin: CLKOUT I _{OL} =+4mA (VDD=3.0V, Ta=25°C)			0.2VDD	V
Current Consumption	I _{DD}	No load (VDD=3.0V, Ta=25°C)		3.5		mA
Power down current	I _{pd}	OE="L" FSEL="L" or open		0	10	μA

AC Characteristics

All specifications at VDD: over 2.7 to 3.6V, Ta: -20 to +85°C, Input Frequency: 27MHz,
unless otherwise noted

Parameter	Symbol	Conditions	MIN	TYP	MAX	Unit
Output Clock Duty Cycle ⁽²⁾⁽³⁾			45	50	55	%
Output Clock Rise Time ⁽²⁾⁽³⁾	t _{rise}	0.2VDD to 0.8VDD			4.0	ns
Output Clock Fall Time ⁽²⁾⁽³⁾	t _{fall}	0.2VDD to 0.8VDD			4.0	ns
Output Clock Jitter ⁽²⁾⁽³⁾	Jit	Period, 1σ		15		ps
Output Lock Time ⁽¹⁾	t _{lock}	Power-up		1		ms

- (1) The time that output reaches the target frequency within accuracy of ±0.1% from the point that the power supply reaches VDD
- (2) With the load capacitance specified by the recommended operation conditions
- (3) Design value

Package Information

• Mechanical data (Units:mm)

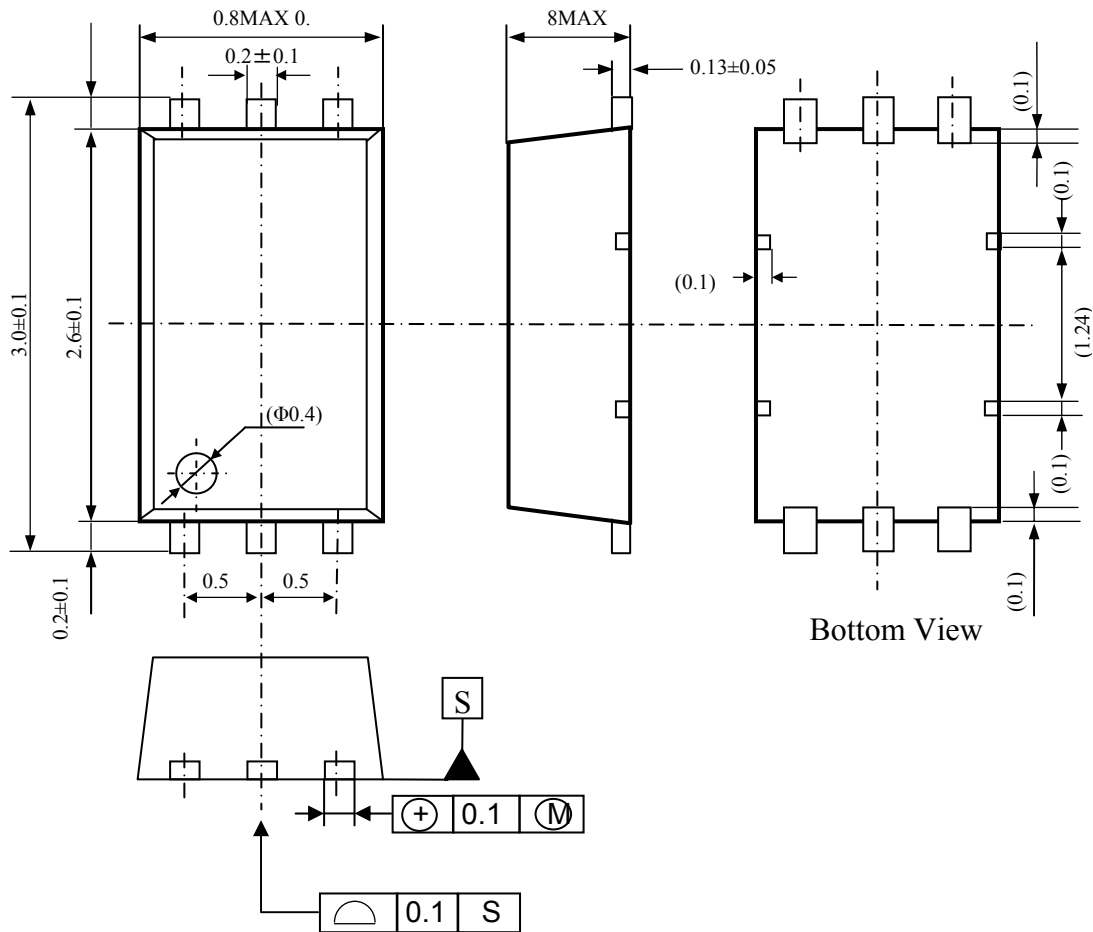

• Marking

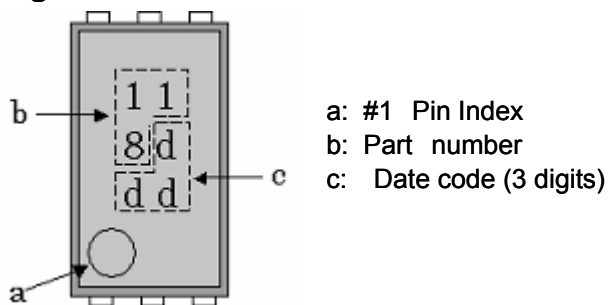

AKM and the logo - **AKM** - are the brand of AKEMD's IC's and identify that AKEMD continues to offer the best choice for high performance mixed-signal solution under this brand.

• RoHS Compliance

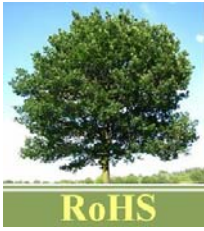

All integrated circuits from Asahi Kasei EMD Corporation (AKEMD) assembled in “lead-free” packages* are fully compliant with RoHS.

(*) RoHS compliant products from AKEMD are identified with “Pb free” letter indication on product label posted on the anti-shield bag and boxes.

IMPORTANT NOTICE

- These products and their specifications are subject to change without notice.
When you consider any use or application of these products, please make inquiries the sales office of Asahi Kasei EMD Corporation (AKEMD) or authorized distributors as to current status of the products.
- AKEMD assumes no liability for infringement of any patent, intellectual property, or other rights in the application or use of any information contained herein.
- Any export of these products, or devices or systems containing them, may require an export license or other official approval under the law and regulations of the country of export pertaining to customs and tariffs, currency exchange, or strategic materials.
- AKEMD products are neither intended nor authorized for use as critical components^{Note1)} in any safety, life support, or other hazard related device or system^{Note2)}, and AKEMD assumes no responsibility for such use, except for the use approved with the express written consent by Representative Director of AKEMD. As used here:
 - Note1) A critical component is one whose failure to function or perform may reasonably be expected to result, whether directly or indirectly, in the loss of the safety or effectiveness of the device or system containing it, and which must therefore meet very high standards of performance and reliability.
 - Note2) A hazard related device or system is one designed or intended for life support or maintenance of safety or for applications in medicine, aerospace, nuclear energy, or other fields, in which its failure to function or perform may reasonably be expected to result in loss of life or in significant injury or damage to person or property.
- It is the responsibility of the buyer or distributor of AKEMD products, who distributes, disposes of, or otherwise places the product with a third party, to notify such third party in advance of the above content and conditions, and the buyer or distributor agrees to assume any and all responsibility and liability for and hold AKEMD harmless from any and all claims arising from the use of said product in the absence of such notification.