

Leiterplatten-Layout Vorschlag für SMT
PCB-Layout Proposal for SMT

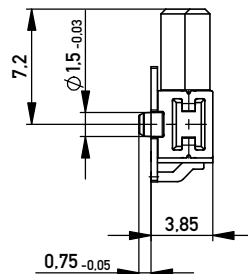
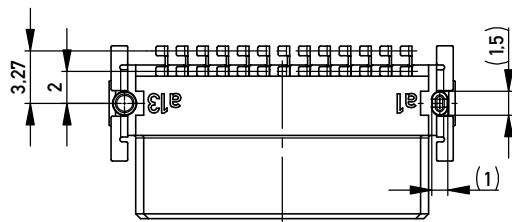
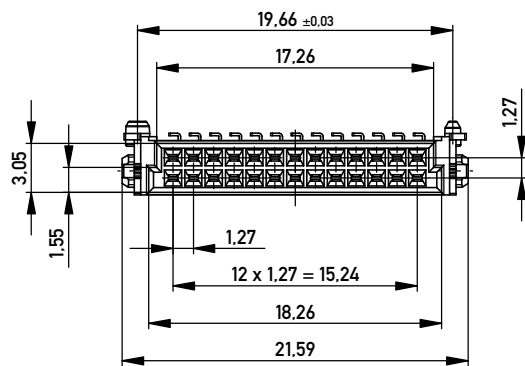
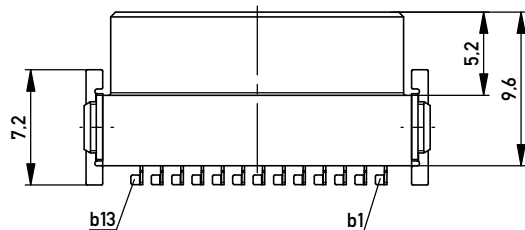
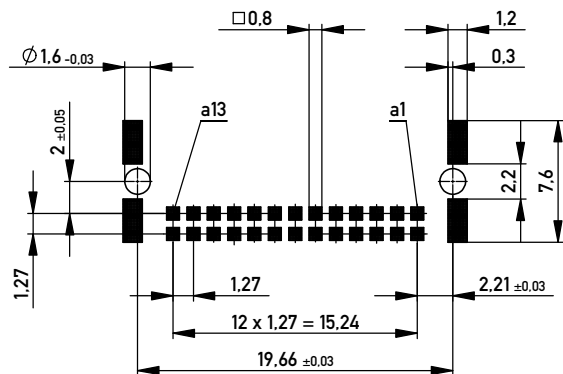

Anforderungsstufe 1
Performance Level 1

Kontaktbereich vergoldet
Mating Area gold plating

Anschlussbereich verzinkt 4-6 µm
Terminal Area 4-6 µm tin plating

Koplanarität der Anschlüsse ≤ 0.1 mm
Coplanarity Area of Termination ≤ 0.1 mm

Verpackt im Gurt nach DIN IEC 60286-3
Tape on Reel Packaging according to DIN IEC 60286-3
Verpackungseinheit: 560 Stück
Packaging unit: 560 pcs

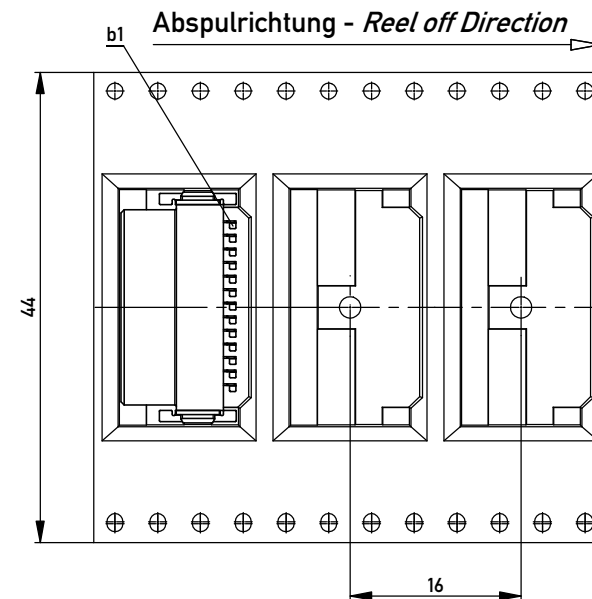
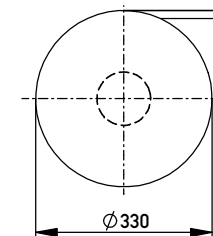

BA7-03 - Standard Bauhöhe

type7-03 - standard assembly height

Information:		Tolerances	All Dimensions in mm	Scale	3:1
All rights reserved. Only for Information. To ensure that this is the latest version of this drawing, please contact one of the ERNI companies before using.		Subject to modification without prior notice. Drawing will not be updated.		Designation	
		www.ERNI.com		Federl. SMC-Q 26-SMD-BA7-03 Female SMC-Q 26-SMD-type7-03	
f	23.04.2014			100400390001	
Index	Date			K A3	
				Class	SMCQ

Copyright by ERNI GmbH
Proprietary notice pursuant to ISO 16018 to be observed.