

40mm sq.

San Ace 40

48mm thick (CRA type), 56mm thick (CRB type)
 56mm thick (CRF type), **56mm thick (CRD type)**
 56mm thick (CRE type), 56mm thick (CRA type)



General Specifications

- Material Frame: Plastics (Flammability: UL94V-0),
 Impeller: Plastics (Flammability: UL94V-0)
- Expected Life Refer to specifications (L10:Survival rate:90% at 60°C ,
 rated voltage, and continuously run in a free air state)
- Lead Wire Inlet ⊕red ⊖black (Sensor) yellow (Control) brown
 Outlet ⊕orange ⊖gray (Sensor) purple (Control) white
- Storage Temperature -30°C to +70°C (Non-condensing)

40×40×56mm (Mass : 90g) **CRD type**

Specifications

The following nos. **have PWM controls and pulse sensors.**

Model No.	Rated Voltage [V]	Operating Voltage Range [V]	PWM duty cycle※ [%]	Rated Current [A]	Rated Input [W]	Rated Speed [min ²] Inlet Outlet	Max. Air Flow [m ³ /min] [CFM]	Max. Static Pressure [Pa] [inchH ₂ O]	SPL [dB(A)]	Operating Temperature [°C]	Expected Life [h]
9CRD0412P5J03	12	10.8 to 13.2	100	1.15	13.8	19,000 12,600	0.87 30.72	630 2.53	61	-20 to +70	40,000
			0	0.12	1.44	3,700 2,500	0.15 5.30	25 0.10	22		
9CRD0412P5G03			100	0.90	10.8	16,700 11,250	0.77 27.19	500 2.01	58		
			0	0.10	1.2	3,350 2,250	0.13 4.59	21 0.08	21		
9CRD0412P5H03			100	0.60	7.2	15,000 10,000	0.70 24.72	410 1.65	56		
			0	0.09	1.08	3,000 2,000	0.12 4.24	16 0.06	20		
9CRD0412P5M03	100	0.52	6.24	14,000 9,300	0.65 22.95	360 1.45	54				
	0	0.07	0.84	2,000 1,300	0.07 2.47	7 0.03	15				

※PWM Frequency : 25kHz

Available options: ⇒ **Without Sensor** **Pulse Sensor**

Dimensions (Unit : mm)

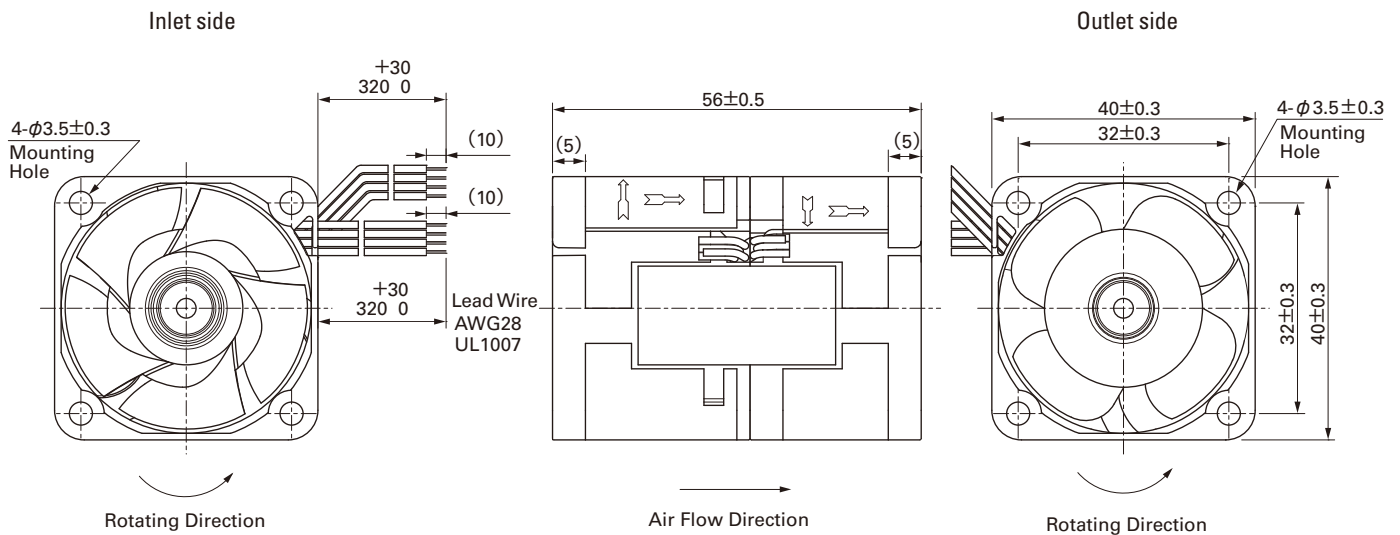

Reference dimension of mounting holes and vent opening (Unit : mm)

Inlet side, Outlet side

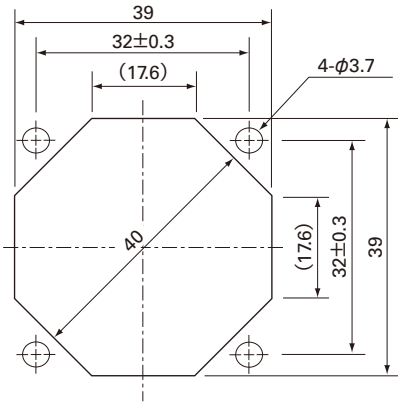

Options (Unit : mm)

Finger guards

Model : 109-059 Surface treatment : Nickel-chrome plating (silver) Color

Inlet side, Outlet side

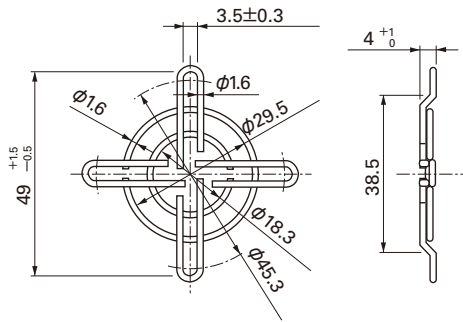

40mm sq.

San Ace 40

40×40×56mm [Mass : 90g]

Air Flow - Static Pressure Characteristics

PWM Duty Cycle

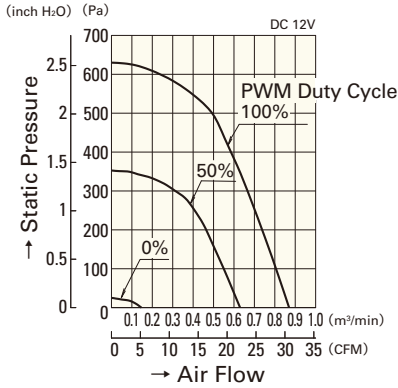

9CRD0412P5J03

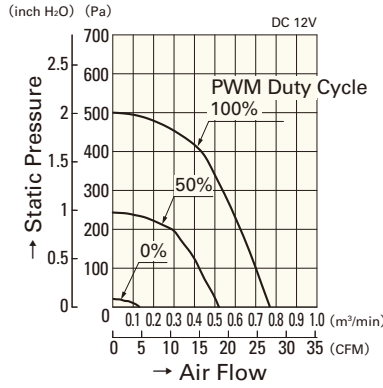

9CRD0412P5G03

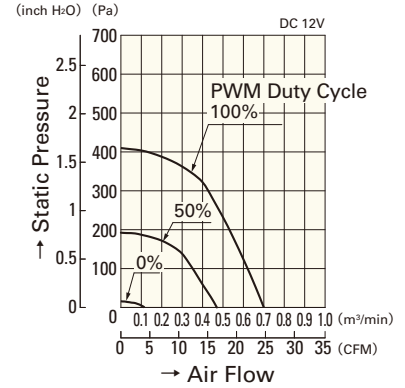

9CRD0412P5H03

Operating Voltage Range

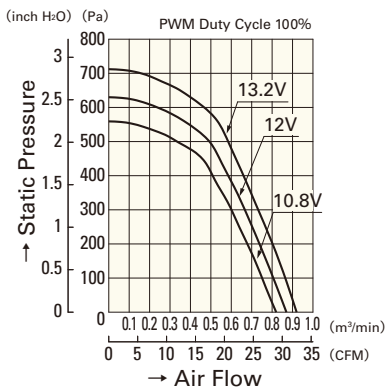

9CRD0412P5J03

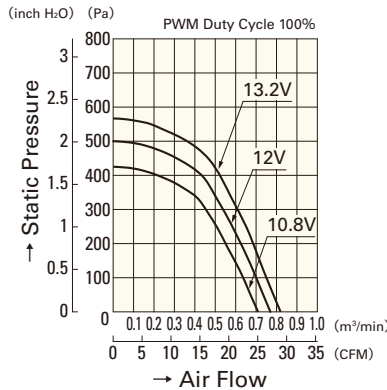

9CRD0412P5G03

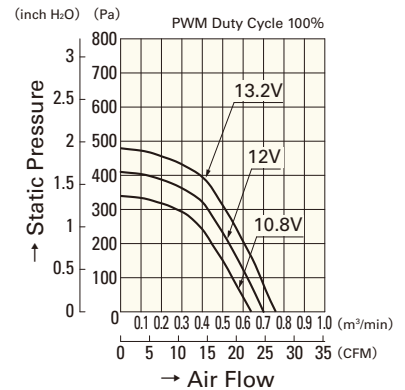

9CRD0412P5H03

PWM Duty - Speed Characteristics Example

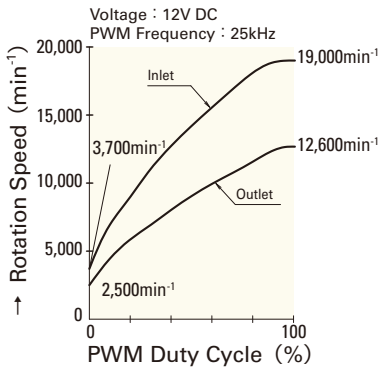

9CRD0412P5J03

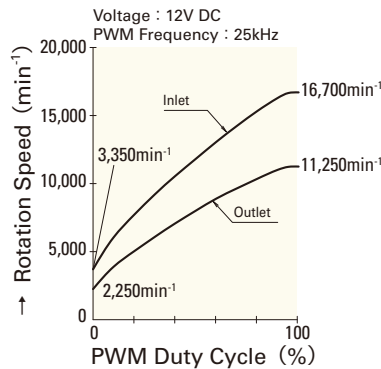

9CRD0412P5G03

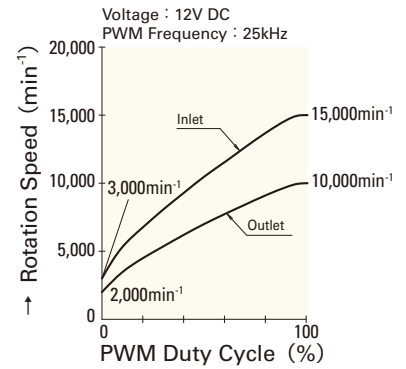

9CRD0412P5H03

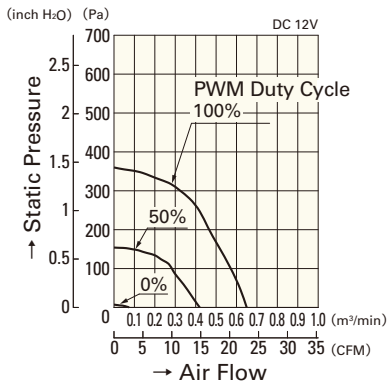

9CRD0412P5M03

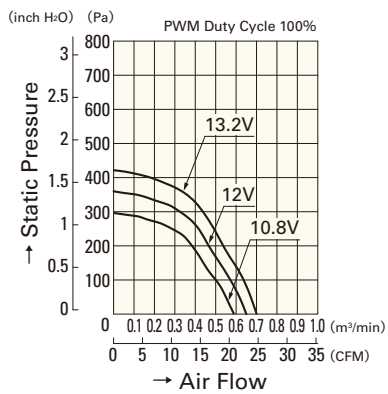

9CRD0412P5M03

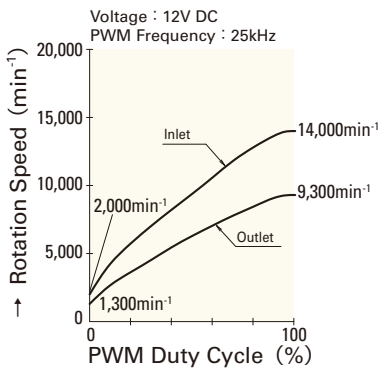

9CRD0412P5M03