

FFB3946

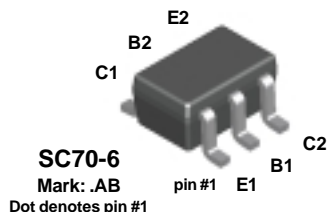

TRANSISTOR TYPE			
C1	B1	E1	NPN
C2	B2	E2	PNP

FMB3946

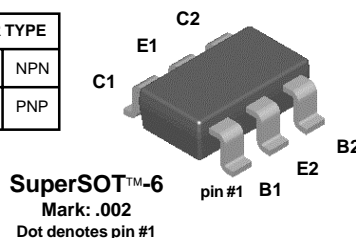

NPN & PNP General Purpose Amplifier

This complementary device is designed for use as a general purpose amplifier and switch. The useful dynamic range extends to 100 mA as a switch and 100 MHz as an amplifier. Sourced from Process 23 and 66. See FFB3904 (NPN) and FFB3906 (PNP) for characteristics.

Absolute Maximum Ratings*

$T_A = 25^\circ\text{C}$ unless otherwise noted

Symbol	Parameter	Value	Units
V_{CE0}	Collector-Emitter Voltage	40	V
V_{CBO}	Collector-Base Voltage	40	V
V_{EBO}	Emitter-Base Voltage	5.0	V
I_C	Collector Current - Continuous	200	mA
T_J, T_{stg}	Operating and Storage Junction Temperature Range	-55 to +150	$^\circ\text{C}$

*These ratings are limiting values above which the serviceability of any semiconductor device may be impaired.

NOTES:

- 1) These ratings are based on a maximum junction temperature of 150 degrees C.
- 2) These are steady state limits. The factory should be consulted on applications involving pulsed or low duty cycle operations.
- 3) All voltages (V) and currents (A) are negative polarity for PNP transistors.

Thermal Characteristics

$T_A = 25^\circ\text{C}$ unless otherwise noted

Symbol	Characteristic	Max		Units
		FFB3946	FMB3946	
P_D	Total Device Dissipation	300	700	mW
	Derate above 25°C	2.4	5.6	mW/ $^\circ\text{C}$
$R_{\theta JA}$	Thermal Resistance, Junction to Ambient	415	180	$^\circ\text{C}/\text{W}$

NPN & PNP General Purpose Amplifier

(continued)

Electrical Characteristics

$T_A = 25^\circ\text{C}$ unless otherwise noted

Symbol	Parameter	Test Conditions	Min	Typ	Max	Units
--------	-----------	-----------------	-----	-----	-----	-------

OFF CHARACTERISTICS

$V_{(BR)CEO}$	Collector-Emitter Breakdown Voltage	$I_C = 10\text{ mA}, I_B = 0$	40			V
$V_{(BR)CBO}$	Collector-Base Breakdown Voltage	$I_C = 10\ \mu\text{A}, I_E = 0$	40			V
$V_{(BR)EBO}$	Emitter-Base Breakdown Voltage	$I_E = 10\ \mu\text{A}, I_C = 0$	5.0			V
I_{CBO}	Collector Cutoff Current	$V_{CB} = 30\text{ V}, I_E = 0$			50	nA
I_{EBO}	Emitter Cutoff Current	$V_{EB} = 4.0\text{ V}, I_C = 0$			50	nA

ON CHARACTERISTICS

h_{FE}	DC Current Gain	$I_C = 100\ \mu\text{A}, V_{CE} = 1.0\text{ V}$ $I_C = 1.0\text{ mA}, V_{CE} = 1.0\text{ V}$ $I_C = 10\text{ mA}, V_{CE} = 1.0\text{ V}$ $I_C = 50\text{ mA}, V_{CE} = 1.0\text{ V}$ $I_C = 100\text{ mA}, V_{CE} = 1.0\text{ V}$	40		300	
$V_{CE(sat)}$	Collector-Emitter Saturation Voltage	$I_C = 10\text{ mA}, I_B = 1.0\text{ mA}$			0.25	V
$V_{BE(sat)}$	Base-Emitter Saturation Voltage	$I_C = 10\text{ mA}, I_B = 1.0\text{ mA}$			0.9	V

SMALL SIGNAL CHARACTERISTICS

f_T	Current Gain - Bandwidth Product	$I_C = 10\text{ mA}, V_{CE} = 20\text{ V},$ $f = 100\text{ MHz}$		200		MHz
C_{obo}	Output Capacitance	$V_{CB} = 5.0\text{ V}, f = 100\text{ kHz}$		4.5		pF
C_{ibo}	Input Capacitance	$V_{CB} = 5.0\text{ V}, f = 100\text{ kHz}$		10		pF

NOTE: All voltages (V) and currents (A) are negative polarity for PNP transistors.

FFB3946 / FMB3946

SC70-6 Tape and Reel Data



SC70-6 Packaging Configuration: Figure 1.0

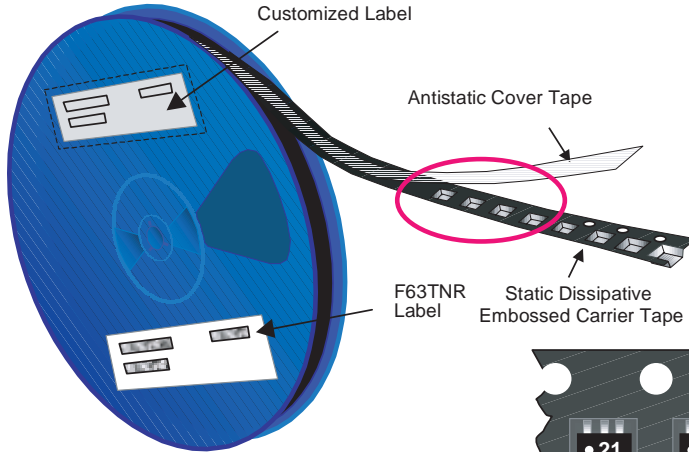

Packaging Description:
 SC70-6 parts are shipped in tape. The carrier tape is made from a dissipative (carbon filled) polycarbonate resin. The cover tape is a multilayer film (Heat Activated Adhesive in nature) primarily composed of polyester film, adhesive layer, sealant, and anti-static sprayed agent. These reeled parts in standard option are shipped with 3,000 units per 7" or 177cm diameter reel. The reels are dark blue in color and is made of polystyrene plastic (anti-static coated). Other option comes in 10,000 units per 13" or 330cm diameter reel. This and some other options are described in the Packaging Information table.
 These full reels are individually barcode labeled and placed inside a pizza box (illustrated in figure 1.0) made of recyclable corrugated brown paper with a Fairchild logo printing. One pizza box contains three reels maximum. And these pizza boxes are placed inside a barcode labeled shipping box which comes in different sizes depending on the number of parts shipped.

SC70-6 Packaging Information		
Packaging Option	Standard (no flow code)	D87Z
Packaging type	TNR	TNR
Qty per Reel/Tube/Bag	3,000	10,000
Reel Size	7" Dia	13"
Box Dimension (mm)	184x187x47	343x343x64
Max qty per Box	9,000	30,000
Weight per unit (gm)	0.0055	0.0055
Weight per Reel (kg)	0.1140	0.3960
Note/Comments		

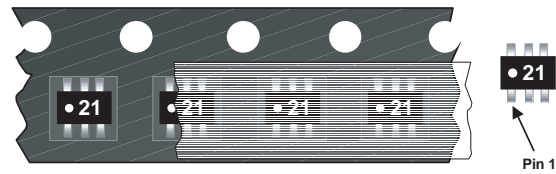

SC70-6 Unit Orientation

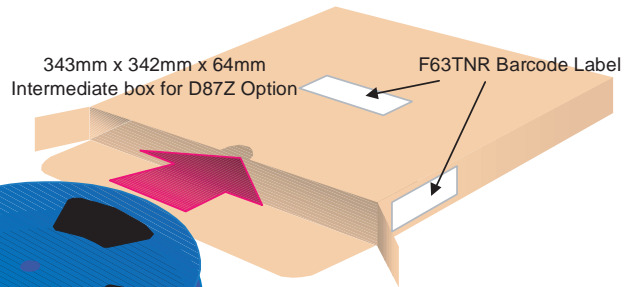
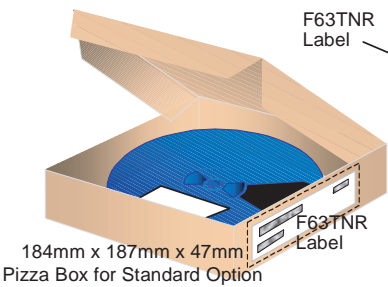

F63TNR Label sample



SC70-6 Tape Leader and Trailer Configuration: Figure 2.0

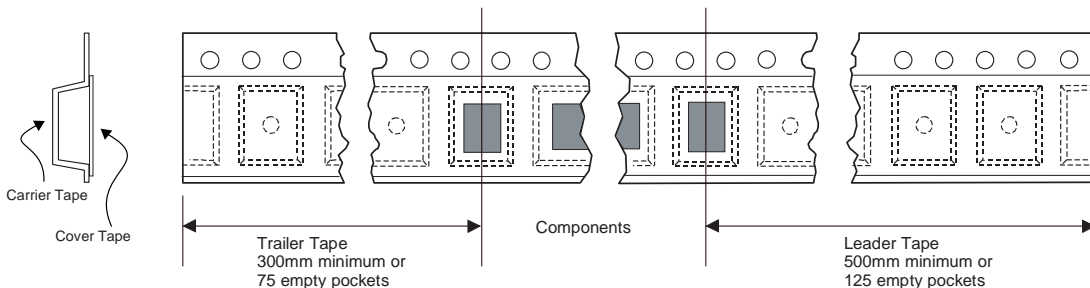

SC70-6 Tape and Reel Data, continued

SC70-6 Embossed Carrier Tape Configuration: Figure 3.0

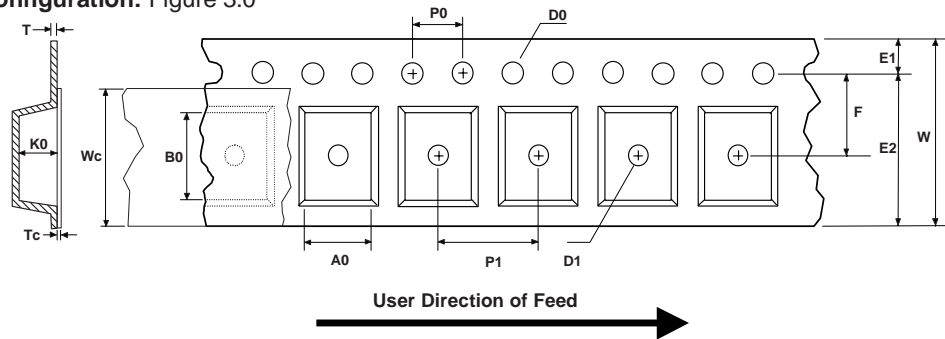

Dimensions are in millimeter

Pkg type	A0	B0	W	D0	D1	E1	E2	F	P1	P0	K0	T	Wc	Tc
SC70-6 (8mm)	2.24 +/-0.10	2.34 +/-0.10	8.0 +/-0.3	1.55 +/-0.05	1.125 +/-0.125	1.75 +/-0.10	6.25 min	3.50 +/-0.05	4.0 +/-0.1	4.0 +/-0.1	1.20 +/-0.10	0.255 +/-0.150	5.2 +/-0.3	0.06 +/-0.02

Notes: A0, B0, and K0 dimensions are determined with respect to the EIA/Jedec RS-481 rotational and lateral movement requirements (see sketches A, B, and C).

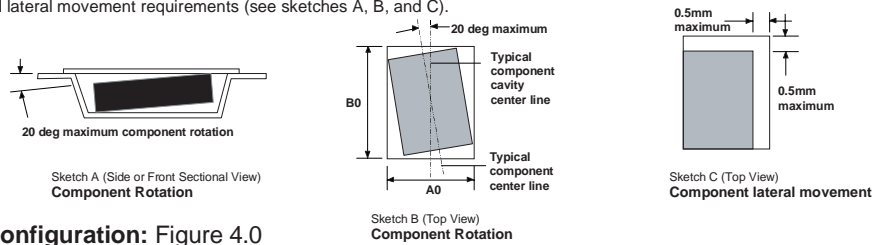

SC70-6 Reel Configuration: Figure 4.0

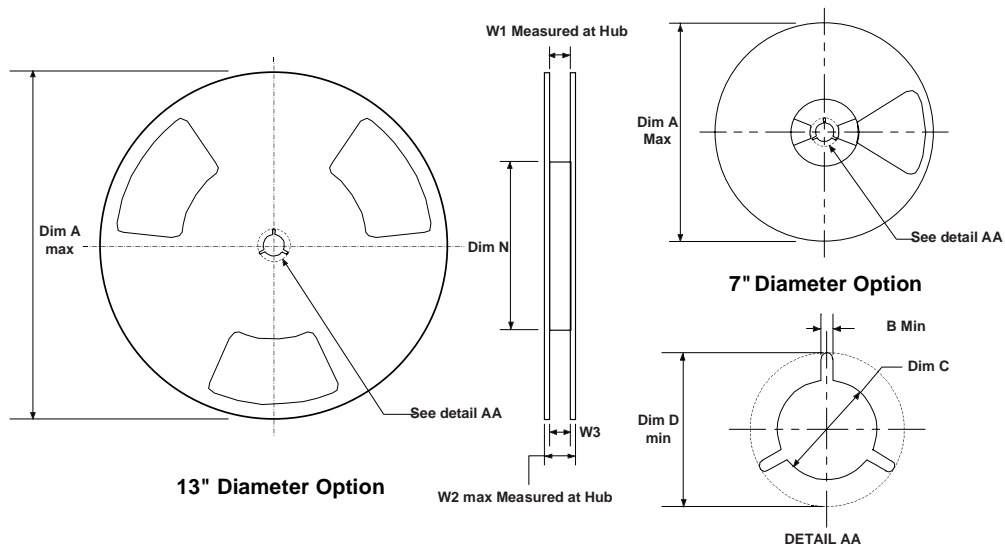

Dimensions are in inches and millimeters

Tape Size	Reel Option	Dim A	Dim B	Dim C	Dim D	Dim N	Dim W1	Dim W2	Dim W3 (LSL-USL)
8mm	7" Dia	7.00 177.8	0.059 1.5	0.512 +0.020/-0.008 13 +0.5/-0.2	0.795 20.2	2.165 55	0.331 +0.059/-0.000 8.4 +1.5/0	0.567 14.4	0.311 - 0.429 7.9 - 10.9
8mm	13" Dia	13.00 330	0.059 1.5	0.512 +0.020/-0.008 13 +0.5/-0.2	0.795 20.2	4.00 100	0.331 +0.059/-0.000 8.4 +1.5/0	0.567 14.4	0.311 - 0.429 7.9 - 10.9

SC70-6 Package Dimensions



SC70-6 (FS PKG Code 76)

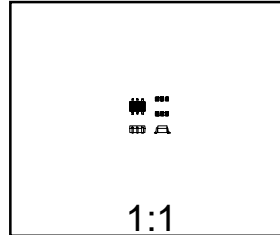
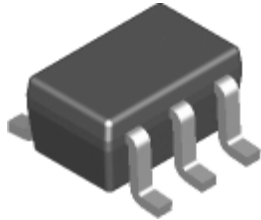

Scale 1:1 on letter size paper

Dimensions shown below are in:
inches [millimeters]

Part Weight per unit (gram): 0.0055

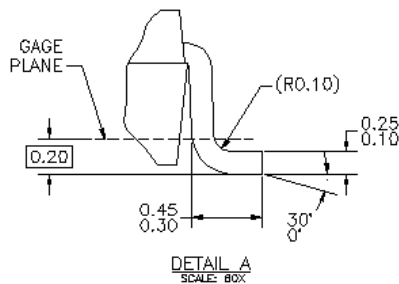
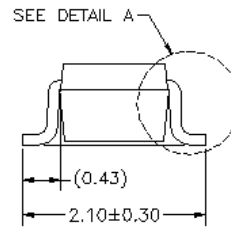
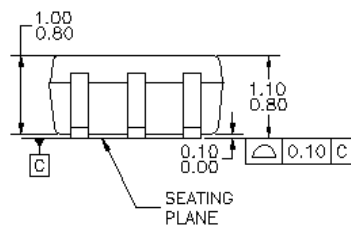
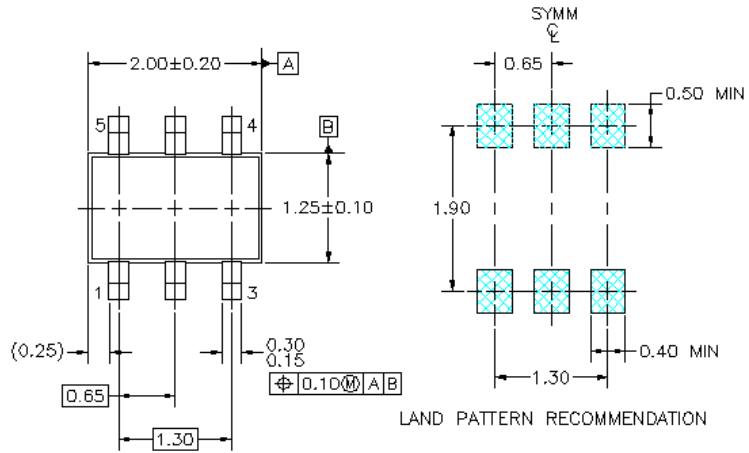

NOTES: UNLESS OTHERWISE SPECIFIED

- A) THIS PACKAGE CONFORMS TO EIAJ SC-88, 1996.
- B) ALL DIMENSIONS ARE IN MILLIMETERS.
- C) DIMENSIONS DO NOT INCLUDE BURRS OR MOLD FLASH.

SuperSOT™-6 Tape and Reel Data



SSOT-6 Packaging Configuration: Figure 1.0

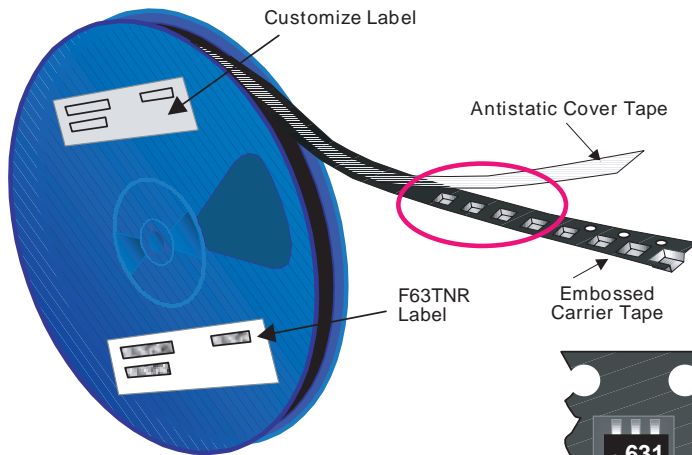

Packaging Description:

SSOT-6 parts are shipped in tape. The carrier tape is made from a dissipative (carbon filled) polycarbonate resin. The cover tape is a multilayer film (Heat Activated Adhesive in nature) primarily composed of polyester film, adhesive layer, sealant, and anti-static sprayed agent. These reeled parts in standard option are shipped with 3,000 units per 7" or 177cm diameter reel. The reels are dark blue in color and is made of polystyrene plastic (anti-static coated). Other option comes in 10,000 units per 13" or 330cm diameter reel. This and some other options are described in the Packaging Information table.

These full reels are individually barcode labeled and placed inside a pizza box (illustrated in figure 1.0) made of recyclable corrugated brown paper with a Fairchild logo printing. One pizza box contains three reels maximum. And these pizza boxes are placed inside a barcode labeled shipping box which comes in different sizes depending on the number of parts shipped.

SSOT-6 Packaging Information		
Packaging Option	Standard (no flow code)	D87Z
Packaging type	TNR	TNR
Qty per Reel/Tube/Bag	3,000	10,000
Reel Size	7" Dia	13"
Box Dimension (mm)	184x187x47	343x343x64
Max qty per Box	9,000	30,000
Weight per unit (gm)	0.0158	0.0158
Weight per Reel (kg)	0.1440	0.4700
Note/Comments		

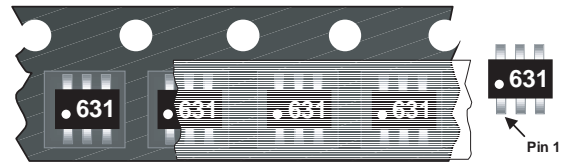

SSOT-6 Unit Orientation

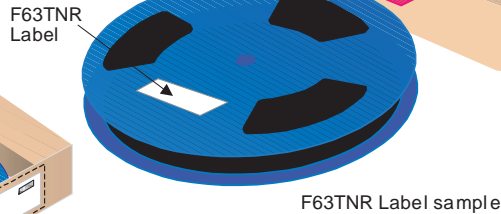
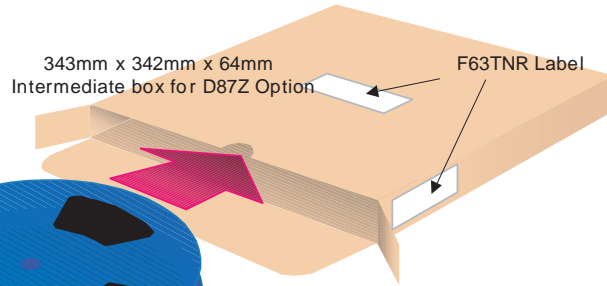
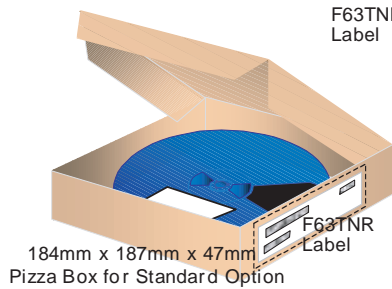

LOT: CBVK741B019	QTY: 3000
FSID: FDC633N	SPEC:
D/C1: D9842	QTY1:
D/C2:	QTY2:
SPEC REV:	CPN:
N/F: F	(F63TNR)3

SSOT-6 Tape Leader and Trailer Configuration: Figure 2.0

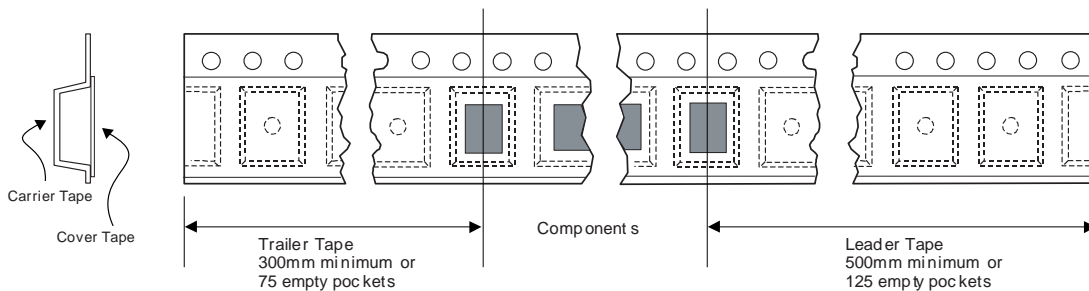

SuperSOT™-6 Tape and Reel Data, continued

SSOT-6 Embossed Carrier Tape Configuration: Figure 3.0

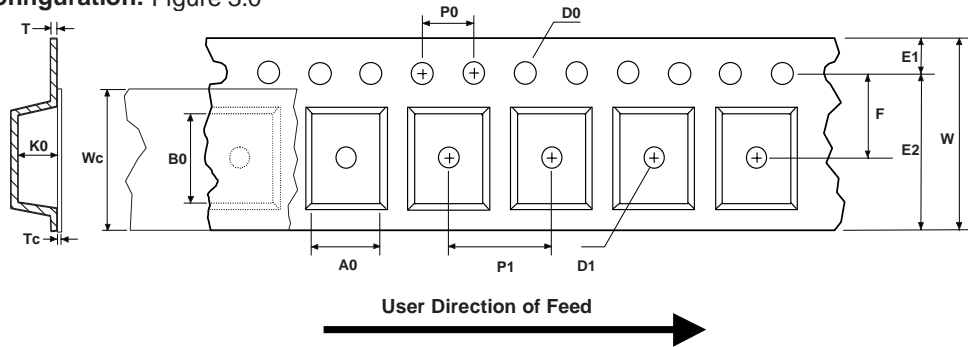

Dimensions are in millimeter														
Pkg type	A0	B0	W	D0	D1	E1	E2	F	P1	P0	K0	T	Wc	Tc
SSOT-6 (8mm)	3.23 +/-0.10	3.18 +/-0.10	8.0 +/-0.3	1.55 +/-0.05	1.125 +/-0.125	1.75 +/-0.10	6.25 min	3.50 +/-0.05	4.0 +/-0.1	4.0 +/-0.1	1.37 +/-0.10	0.255 +/-0.150	5.2 +/-0.3	0.06 +/-0.02

Notes: A0, B0, and K0 dimensions are determined with respect to the EIA/Jedec RS-481 rotational and lateral movement requirements (see sketches A, B, and C).

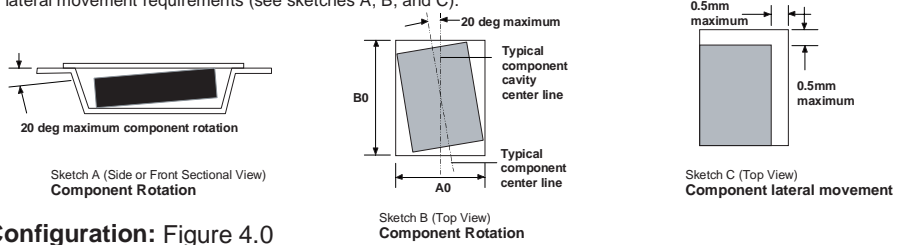

SSOT-6 Reel Configuration: Figure 4.0

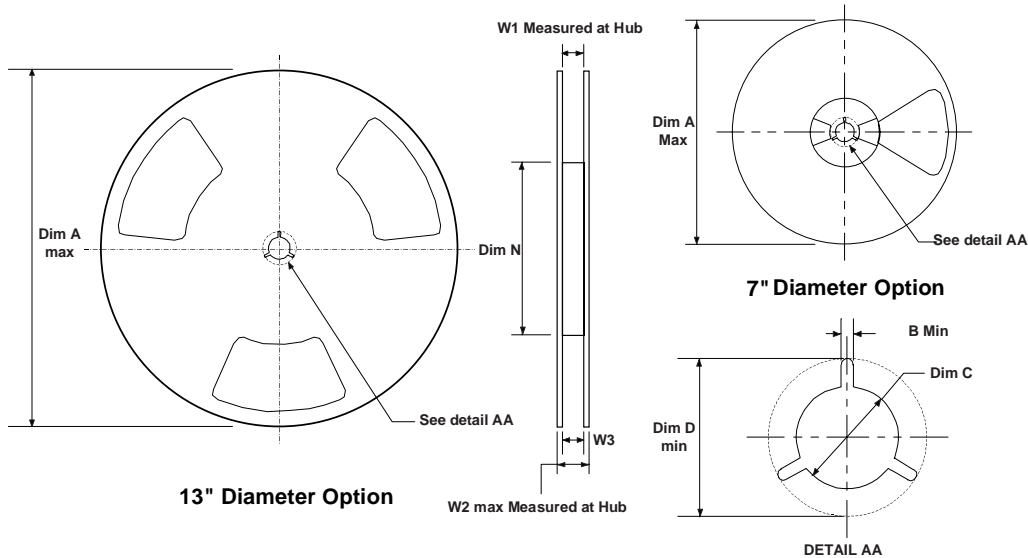

Dimensions are in inches and millimeters									
Tape Size	Reel Option	Dim A	Dim B	Dim C	Dim D	Dim N	Dim W1	Dim W2	Dim W3 (LSL-USL)
8mm	7" Dia	7.00 177.8	0.059 1.5	512+0.020/-0.008 13 +0.5/-0.2	0.795 20.2	2.165 55	0.331+0.059/-0.000 8.4+1.5/0	0.567 14.4	0.311 - 0.429 7.9 - 10.9
8mm	13" Dia	13.00 330	0.059 1.5	512+0.020/-0.008 13 +0.5/-0.2	0.795 20.2	4.00 100	0.331+0.059/-0.000 8.4+1.5/0	0.567 14.4	0.311 - 0.429 7.9 - 10.9

SuperSOT™-6 Package Dimensions



SuperSOT™-6 (FS PKG Code 31, 33)

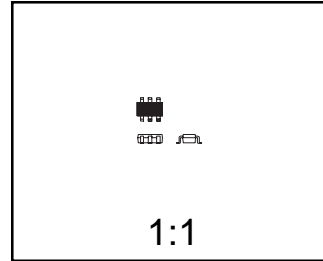
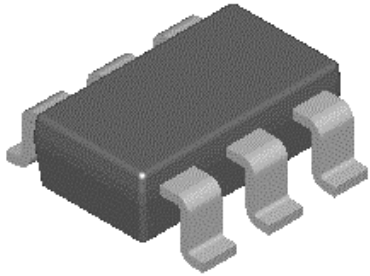

Scale 1:1 on letter size paper

Dimensions shown below are in:
inches [millimeters]

Part Weight per unit (gram): 0.0158

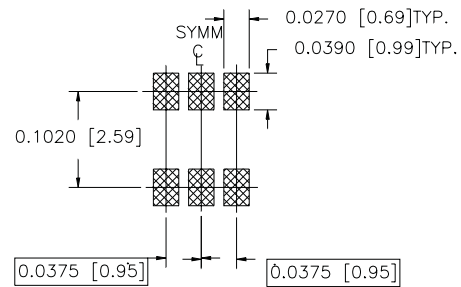
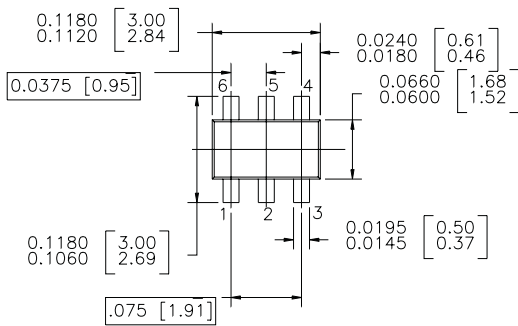

LAND PATTERN RECOMMENDATION

CONTROLLING DIMENSION IS INCH
VALUES IN [] ARE MILLIMETERS

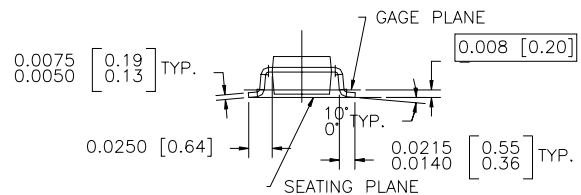
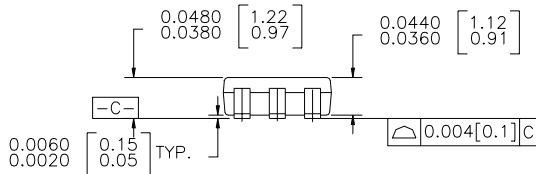

SUPER SOT 6 LEADS

NOTES : UNLESS OTHERWISE SPECIFIED

1.0 STANDARD LEAD FINISH : 150 MICROINCHES 93.81 MICROMETERS)
MINIMUM TIN / LEAD (SOLDER) ON COPPER.

2.0 NO JEDEC REGISTRATION AS OF JULY 1996

TRADEMARKS

The following are registered and unregistered trademarks Fairchild Semiconductor owns or is authorized to use and is not intended to be an exhaustive list of all such trademarks.

ACEx™	FASTr™	PowerTrench®	SyncFET™
Bottomless™	GlobalOptoisolator™	QFET™	TinyLogic™
CoolFET™	GTO™	QS™	UHC™
CROSSVOLT™	HiSeC™	QT Optoelectronics™	VCX™
DOME™	ISOPLANAR™	Quiet Series™	
E ² CMOS™	MICROWIRE™	SILENT SWITCHER®	
EnSigna™	OPTOLOGIC™	SMART START™	
FACT™	OPTOPLANAR™	SuperSOT™-3	
FACT Quiet Series™	PACMAN™	SuperSOT™-6	
FAST®	POP™	SuperSOT™-8	

DISCLAIMER

FAIRCHILD SEMICONDUCTOR RESERVES THE RIGHT TO MAKE CHANGES WITHOUT FURTHER NOTICE TO ANY PRODUCTS HEREIN TO IMPROVE RELIABILITY, FUNCTION OR DESIGN. FAIRCHILD DOES NOT ASSUME ANY LIABILITY ARISING OUT OF THE APPLICATION OR USE OF ANY PRODUCT OR CIRCUIT DESCRIBED HEREIN; NEITHER DOES IT CONVEY ANY LICENSE UNDER ITS PATENT RIGHTS, NOR THE RIGHTS OF OTHERS.

LIFE SUPPORT POLICY

FAIRCHILD'S PRODUCTS ARE NOT AUTHORIZED FOR USE AS CRITICAL COMPONENTS IN LIFE SUPPORT DEVICES OR SYSTEMS WITHOUT THE EXPRESS WRITTEN APPROVAL OF FAIRCHILD SEMICONDUCTOR CORPORATION. As used herein:

1. Life support devices or systems are devices or systems which, (a) are intended for surgical implant into the body, or (b) support or sustain life, or (c) whose failure to perform when properly used in accordance with instructions for use provided in the labeling, can be reasonably expected to result in significant injury to the user.
2. A critical component is any component of a life support device or system whose failure to perform can be reasonably expected to cause the failure of the life support device or system, or to affect its safety or effectiveness.

PRODUCT STATUS DEFINITIONS

Definition of Terms

Datasheet Identification	Product Status	Definition
Advance Information	Formative or In Design	This datasheet contains the design specifications for product development. Specifications may change in any manner without notice.
Preliminary	First Production	This datasheet contains preliminary data, and supplementary data will be published at a later date. Fairchild Semiconductor reserves the right to make changes at any time without notice in order to improve design.
No Identification Needed	Full Production	This datasheet contains final specifications. Fairchild Semiconductor reserves the right to make changes at any time without notice in order to improve design.
Obsolete	Not In Production	This datasheet contains specifications on a product that has been discontinued by Fairchild semiconductor. The datasheet is printed for reference information only.