

Main Product Characteristics:

IF	2×5A
VRRM	200V
T _J (max)	150°C
V _f (max)	0.8V

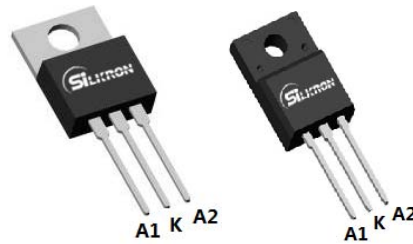

TO220

SSBD10L200CT

TO220F

SSBD10L200CTF

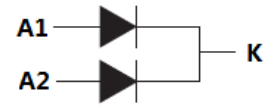

Schematic Diagram

Features and Benefits:

- High Junction Temperature
- High ESD Protection
- High Forward & Reverse Surge capability



Description:

Schottky Barrier Rectifier designed for high frequency switch mode power supplies such as adaptors and DC/DC converters; this product special design for high forward and reverse surge capability

Absolute Rating:

Symbol	Characterizes	Value	Unit
V _{RRM}	Peak Repetitive Reverse Voltage	200	V
V _{R(RMS)}	RMS Reverse Voltage	140	V
I _{F(AV)}	Average Forward Current	Per diode	5
		Per device	10
I _{FSM}	Non Repetitive Surge Forward Current(tp=8.3ms sinusoidal)	180	A
I _{RRM}	Peak Repetitive Reverse Surge Current(Tp=2us)	0.5	A
T _J	Maximum operation Junction Temperature Range	-55~150	°C
T _{stg}	Storage Temperature Range	-55~150	°C

Thermal Resistance

Symbol	Characterizes	Value	Unit
R _{θJC}	Maximum Thermal Resistance Junction To Case(per leg)	TO220	2
R _{θJC}		TO220F	4

Electrical Characterizes @T_A=25°C unless otherwise specified

Symbol	Characterizes	Min	Typ	Max	Unit	Test Condition
V _R	Reverse Breakdown Voltage	200			V	I _R =0.5mA
V _F	Forward Voltage Drop			0.8	V	I _F =5A, T _J =25°C
				0.9		I _F =10A, T _J =25°C
				0.7		I _F =5A, T _J =125°C
I _R	Leakage Current			0.1	mA	V _R =200V, T _J =25°C
				5		V _R =200V, T _J =125°C

I-V Curves:

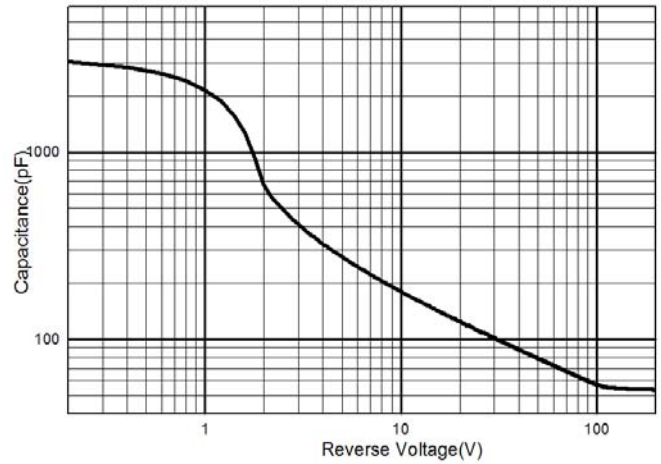
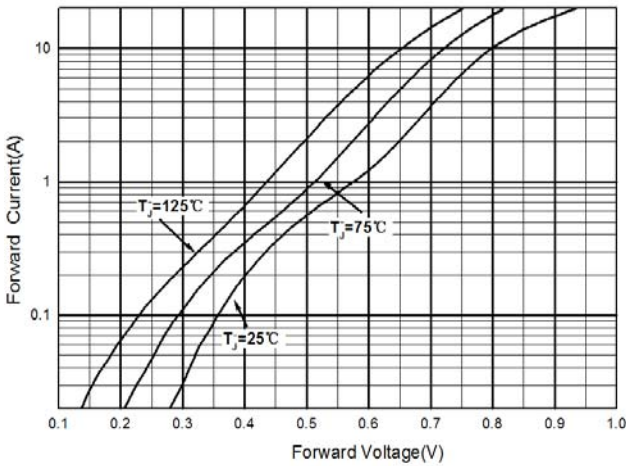

Figure 1: Typical Forward Characteristics

Figure 2: Typical Capacitance Characteristics

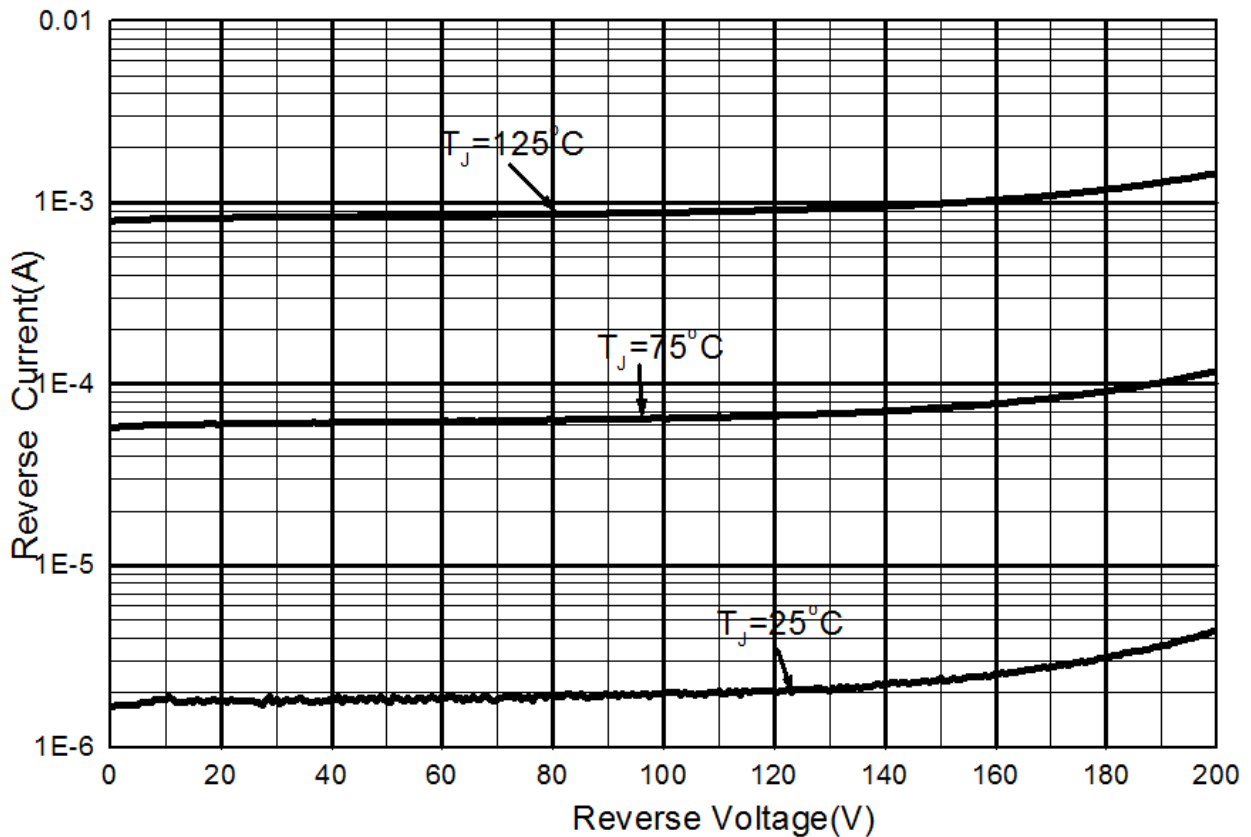
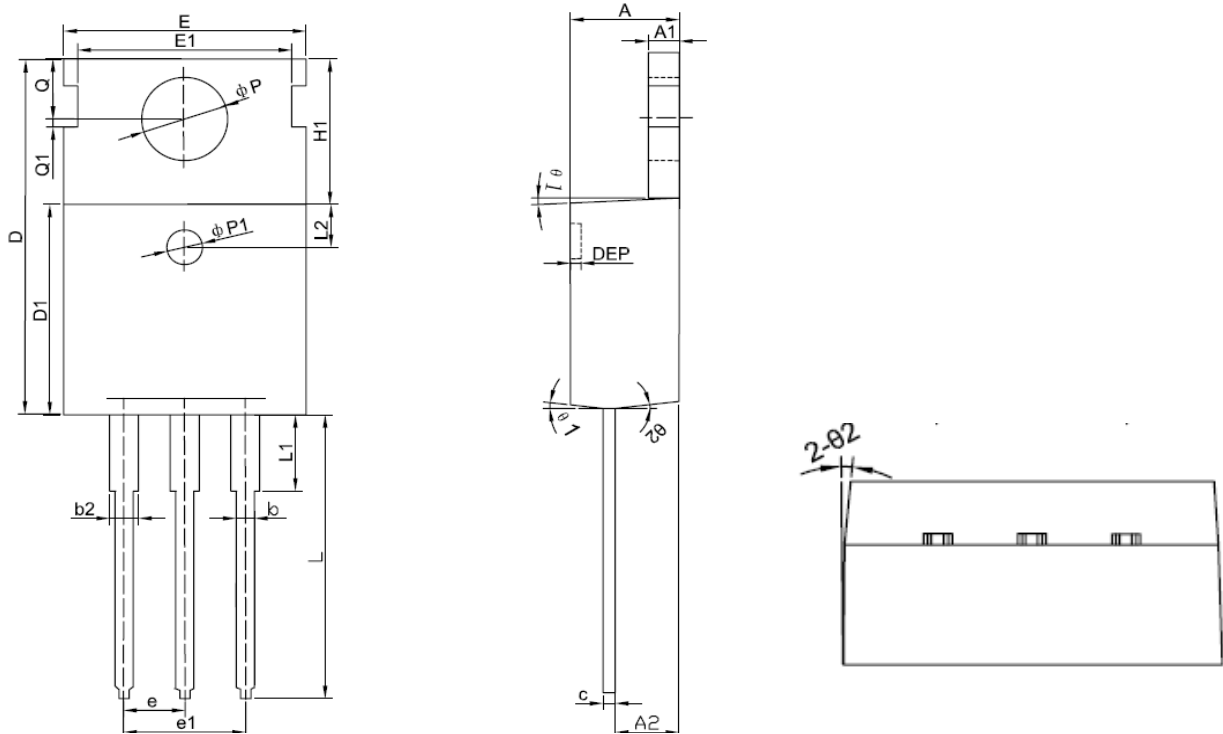
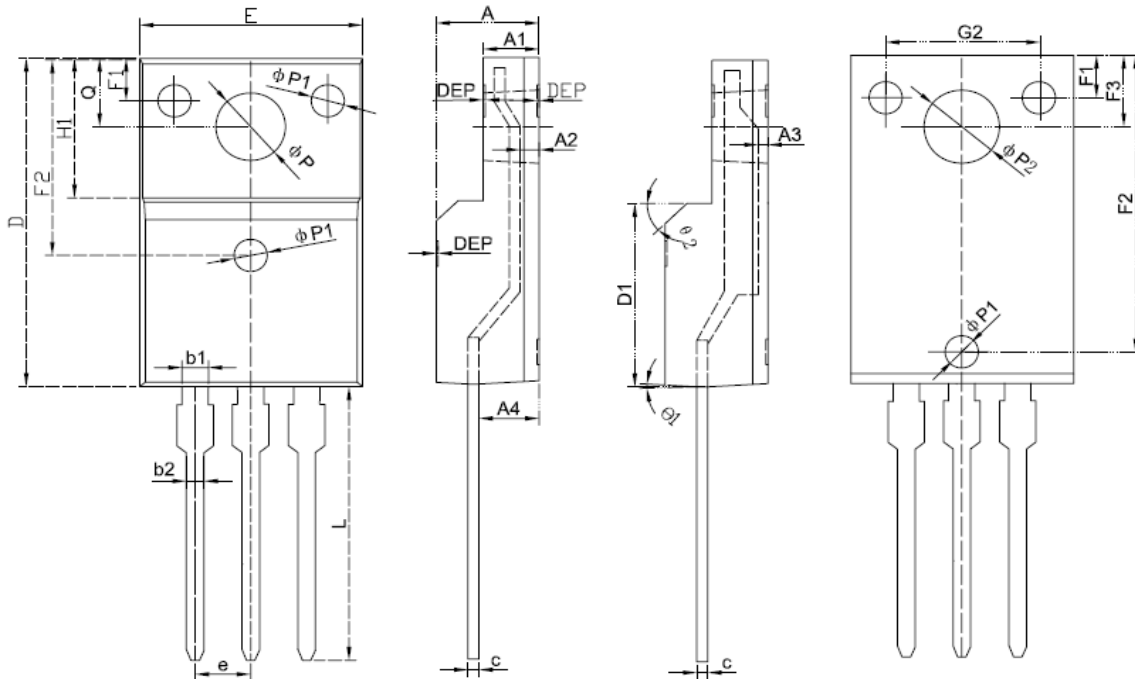

Figure 3: Typical Reverse Characteristics

Mechanical Data:
TO220:

Symbol	Dimension In Millimeters			Dimension In Inches		
	Min	Nom	Max	Min	Nom	Max
A	4.400	4.550	4.700	0.173	0.179	0.185
A1	1.270	1.300	1.330	0.050	0.051	0.052
A2	2.590	2.690	2.790	0.102	0.106	0.110
b	0.770	-	0.900	0.030	-	0.035
b2	1.230	-	1.360	0.048	-	0.054
c	0.480	0.500	0.520	0.019	0.020	0.020
D	15.100	15.400	15.700	-	0.606	-
D1	9.000	9.100	9.200	0.354	0.358	0.362
DEP	0.050	0.285	0.520	0.002	0.011	0.020
E	10.060	10.160	10.260	0.396	0.400	0.404
E1	-	8.700	-	-	0.343	-
ΦP1	1.400	1.500	1.600	0.055	0.059	0.063
e	2.54BSC			0.1BSC		
e1	5.08BSC			0.2BSC		
H1	6.100	6.300	6.500	0.240	0.248	0.256
L	12.750	12.960	13.170	0.502	0.510	0.519
L1	-	-	3.950	-	-	0.156
L2	1.85REF			0.073REF		
ΦP	3.570	3.600	3.630	0.141	0.142	0.143
Q	2.730	2.800	2.870	0.107	0.110	0.113
Q1	-	0.200	-	-	0.008	-
Θ1	5°	7°	9°	5°	7°	9°
Θ2	1°	3°	5°	1°	3°	5°

TO220F:

Symbol	Dimension In Millimeters			Dimension In Inches		
	Min	Nom	Max	Min	Nom	Max
E	9.960	10.160	10.360	0.392	0.400	0.408
A	4.500	4.700	4.900	0.177	0.185	0.193
A1	2.340	2.540	2.740	0.092	0.100	0.108
A2	0.950	1.050	1.150	0.037	0.041	0.045
A3	0.420	0.520	0.620	0.017	0.020	0.024
A4	2.650	2.750	2.850	0.104	0.108	0.112
c	-	0.500	-	-	0.020	-
D	15.670	15.870	16.070	0.617	0.625	0.633
Q	3.200	3.300	3.400	0.126	0.130	0.134
H1	6.480	6.680	6.880	0.255	0.263	0.271
e	2.54BSC			0.10BSC		
ΦP	-	3.183	-	-	0.125	-
L	12.780	12.980	13.180	0.503	0.511	0.519
D1	8.990	9.190	9.390	0.354	0.362	0.370
$\Phi P1$	1.400	1.500	1.600	0.055	0.059	0.063
$\Phi P2$	-	3.450	-	-	0.136	-
$\theta 1$	4°	5°	6°	4°	5°	6°
$\theta 2$	-	45°	-	-	45°	-
DEP	0.050	0.100	0.150	0.002	0.004	0.006
F1	1.900	2.000	2.100	0.075	0.079	0.083
F2	8.980	9.180	9.380	0.354	0.361	0.369
F3	3.200	3.300	3.400	0.126	0.130	0.134
G2	6.900	7.000	7.100	0.272	0.276	0.280
b1	1.170	1.205	1.240	0.046	0.047	0.049
b2	0.770	0.810	0.850	0.030	0.032	0.033

Ordering and Marking Information
Device Marking: SSBD10L200CT&SSBD10L200CTF
Package (Available)
TO-220&TO220F
Operating Temperature Range
C : -55 to 150 °C
Devices per Unit

Package Type	Units/Tube	Tubes/Inner Box	Units/Inner Box	Inner Boxes/Carton Box	Units/Carton Box
TO220	50	20	1000	6	6000
TO220F	50	20	1000	6	6000

Reliability Test Program

Test Item	Conditions	Duration	Sample Size
High Temperature Reverse Bias(HTRB)	Tj=125°C to 175°C @ 80% of Max VDSS/VCES/VR	168 hours 500 hours 1000 hours	3 lots x 77 devices

ATTENTION:

- Any and all Silikron products described or contained herein do not have specifications that can handle applications that require extremely high levels of reliability, such as life-support systems, aircraft's control systems, or other applications whose failure can be reasonably expected to result in serious physical and/or material damage. Consult with your Silikron representative nearest you before using any Silikron products described or contained herein in such applications.
- Silikron assumes no responsibility for equipment failures that result from using products at values that exceed, even momentarily, rated values (such as maximum ratings, operating condition ranges, or other parameters) listed in products specifications of any and all Silikron products described or contained herein.
- Specifications of any and all Silikron products described or contained herein stipulate the performance, characteristics, and functions of the described products in the independent state, and are not guarantees of the performance, characteristics, and functions of the described products as mounted in the customer's products or equipment. To verify symptoms and states that cannot be evaluated in an independent device, the customer should always evaluate and test devices mounted in the customer's products or equipment.
- Silikron Semiconductor CO.,LTD. strives to supply high-quality high-reliability products. However, any and all semiconductor products fail with some probability. It is possible that these probabilistic failures could give rise to accidents or events that could endanger human lives, that could give rise to smoke or fire, or that could cause damage to other property. When designing equipment, adopt safety measures so that these kinds of accidents or events cannot occur. Such measures include but are not limited to protective circuits and error prevention circuits for safe design, redundant design, and structural design.
- In the event that any or all Silikron products(including technical data, services) described or contained herein are controlled under any of applicable local export control laws and regulations, such products must not be exported without obtaining the export license from the authorities concerned in accordance with the above law.
- No part of this publication may be reproduced or transmitted in any form or by any means, electronic or mechanical, including photocopying and recording, or any information storage or retrieval system, or otherwise, without the prior written permission of Silikron Semiconductor CO.,LTD.
- Information (including circuit diagrams and circuit parameters) herein is for example only ; it is not guaranteed for volume production. Silikron believes information herein is accurate and reliable, but no guarantees are made or implied regarding its use or any infringements of intellectual property rights or other rights of third parties.
- Any and all information described or contained herein are subject to change without notice due to product/technology improvement, etc. When designing equipment, refer to the "Delivery Specification" for the Silikron product that you intend to use.
- This catalog provides information as of Dec, 2008. Specifications and information herein are subject to change without notice.

Customer Service**Worldwide Sales and Service:****Sales@silikron.com****Technical Support:****Technical@silikron.com****Suzhou Silikron Semiconductor Corp.****11A, 428 Xinglong Street, Suzhou Industrial Park, P.R.China****TEL: (86-512) 62560688****FAX: (86-512) 65160705****E-mail: Sales@silikron.com**