



### Features :

- Universal AC input / Full range (up to 305VAC)
- Built-in active PFC function
- Protections: Short circuit / Over current / Over voltage / Over temperature
- Cooling by free air convection
- Output constant current level adjustable
- Class 2 power unit
- Three in one dimming function (1~10Vdc or PWM signal or resistance)
- Suitable for built in LED lighting system
- Suitable for dry / damp locations
- 100% full load burn-in test
- 3 years warranty



### SPECIFICATION

MODEL		HLP-40H-12	HLP-40H-15	HLP-40H-20	HLP-40H-24	HLP-40H-30	HLP-40H-36	HLP-40H-42	HLP-40H-48	HLP-40H-54	
OUTPUT	DC VOLTAGE	12V	15V	20V	24V	30V	36V	42V	48V	54V	
	CONSTANT CURRENT REGION <small>Note.4</small>	7.2 ~ 12V	9 ~ 15V	12 ~ 20V	14.4 ~ 24V	18 ~ 30V	21.6 ~ 36V	25.2 ~ 42V	28.8 ~ 48V	32.4 ~ 54V	
	RATED CURRENT	3.33A	2.67A	2A	1.67A	1.34A	1.12A	0.96A	0.84A	0.75A	
	RATED POWER	40W	40W	40W	40.1W	40.2W	40.3W	40.3W	40.3W	40.5W	
	RIPPLE & NOISE (max.) <small>Note.2</small>	150mVp-p	150mVp-p	150mVp-p	150mVp-p	200mVp-p	200mVp-p	300mVp-p	300mVp-p	300mVp-p	
	VOLTAGE ADJ. RANGE	10.8 ~ 13.5V	13.5 ~ 17V	17 ~ 22V	22 ~ 27V	27 ~ 33V	33 ~ 40V	40 ~ 46V	44 ~ 53V	49 ~ 58V	
	CURRENT ADJ. RANGE	Can be adjusted by internal potentiometer or through output connector									
		2 ~ 3.33A	1.6 ~ 2.67A	1.2 ~ 2A	1 ~ 1.67A	0.8 ~ 1.34A	0.67 ~ 1.12A	0.58 ~ 0.96A	0.5 ~ 0.84A	0.45 ~ 0.75A	
	VOLTAGE TOLERANCE <small>Note.3</small>	±2.5%	±2.0%	±1.0%	±1.0%	±1.0%	±1.0%	±1.0%	±1.0%	±1.0%	
	LINE REGULATION	±0.5%	±0.5%	±0.5%	±0.5%	±0.5%	±0.5%	±0.5%	±0.5%	±0.5%	
LOAD REGULATION	±2.0%	±1.5%	±1.0%	±0.5%	±0.5%	±0.5%	±0.5%	±0.5%	±0.5%		
SETUP, RISE TIME <small>Note.6</small>	1500ms, 80ms / 115VAC at full load				1000ms, 80ms / 230VAC at full load						
HOLD UP TIME (Typ.)	16ms/230VAC		16ms/115VAC at full load								
INPUT	VOLTAGE RANGE <small>Note.5</small>	90 ~ 305VAC		127 ~ 431VDC							
	FREQUENCY RANGE	47 ~ 63Hz									
	POWER FACTOR (Typ.)	PF>0.98/115VAC, PF>0.95/230VAC, PF>0.92/277VAC at full load (Please refer to "Power Factor Characteristic" curve)									
	EFFICIENCY (Typ.)	87%	87%	88%	88%	88.5%	89%	89%	89.5%	89.5%	
	AC CURRENT (Typ.)	0.43A / 115VAC		0.24A / 230VAC		0.23A / 277VAC					
	INRUSH CURRENT(Typ.)	COLD START 70A/230VAC									
LEAKAGE CURRENT	<0.75mA / 277VAC										
PROTECTION	OVER CURRENT <small>Note.4</small>	95 ~ 108%									
		Protection type : Constant current limiting, recovers automatically after fault condition is removed									
	SHORT CIRCUIT	Hiccup mode, recovers automatically after fault condition is removed									
	OVER VOLTAGE	15 ~ 21V	18 ~ 24V	23 ~ 30V	28 ~ 35V	35 ~ 43V	41 ~ 49V	48 ~ 58V	54 ~ 63V	59 ~ 68V	
	Protection type : Shut down o/p voltage, re-power on to recover										
OVER TEMPERATURE	85°C ±10°C (RTH2)										
	Protection type : Shut down o/p voltage, re-power on to recover										
ENVIRONMENT	WORKING TEMP.	-40 ~ +70°C (Refer to "Derating Curve")									
	WORKING HUMIDITY	20 ~ 95% RH non-condensing									
	STORAGE TEMP., HUMIDITY	-40 ~ +80°C, 10 ~ 95% RH									
	TEMP. COEFFICIENT	±0.03%/°C (0 ~ 50°C)									
	VIBRATION	10 ~ 500Hz, 2G 12min./1cycle, period for 72min. each along X, Y, Z axes									
SAFETY & EMC	SAFETY STANDARDS	UL8750, CSA C22.2 No. 250.0-08 (except for 48V, 54V), EN61347-1, EN61347-2-13 approved ; design refer to UL60950-1, TUV EN60950-1, EN60335-1									
	WITHSTAND VOLTAGE	I/P-O/P:3.75KVAC I/P-FG:1.88KVAC O/P-FG:0.5KVAC									
	ISOLATION RESISTANCE	I/P-O/P, I/P-FG, O/P-FG:100M Ohms / 500VDC / 25°C / 70% RH									
	EMC EMISSION	Compliance to EN55015, EN61000-3-2 Class C (≥ 60% load) ; EN61000-3-3									
EMC IMMUNITY	Compliance to EN61000-4-2,3,4,5,6,8,11; EN61547, EN55024, light industry level (surge 4KV), criteria A										
OTHERS	MTBF	287.9Khrs min. MIL-HDBK-217F (25°C)									
	DIMENSION	147*53*27mm (L*W*H)									
	PACKING	0.2Kg:72pcs/15.4Kg/1.09CUFT									
NOTE	<ol style="list-style-type: none"> <li>1. All parameters NOT specially mentioned are measured at 230VAC input, rated load and 25°C of ambient temperature.</li> <li>2. Ripple &amp; noise are measured at 20MHz of bandwidth by using a 12" twisted pair-wire terminated with a 0.1uf &amp; 47uf parallel capacitor.</li> <li>3. Tolerance : includes set up tolerance, line regulation and load regulation.</li> <li>4. Constant current operation region is within 60% ~100% rated output voltage. This is the suitable operation region for LED related applications, but please reconfirm special electrical requirements for some specific system design.</li> <li>5. Derating may be needed under low input voltages. Please check the static characteristics for more details.</li> <li>6. Length of set up time is measured at cold first start. Turning ON/OFF the power supply may lead to increase of the set up time.</li> <li>7. The power supply is considered as a component that will be operated in combination with final equipment. Since EMC performance will be affected by the complete installation, the final equipment manufacturers must re-qualify EMC Directive on the complete installation again.</li> </ol>										

## Mechanical Specification

Unit:mm

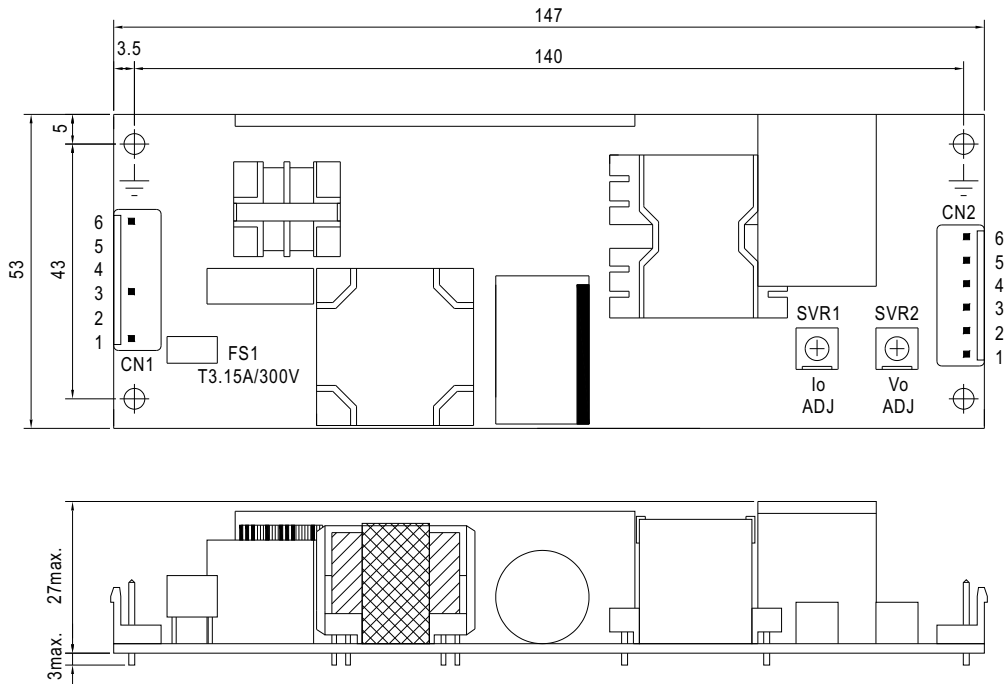

AC Input Connector (CN1) : JST B6P-VH or equivalent

Pin No.	Assignment	Mating Housing	Terminal
1	AC/L	JST VHR or equivalent	JST SVH-21T-P1.1 or equivalent
2,4,5	No Pin		
3	AC/N		
6	FG $\perp$		

DC Output Connector (CN2) : JST B6P-VH or equivalent

Pin No.	Assignment	Mating Housing	Terminal
1	DIM+	JST VHR or equivalent	JST SVH-21T-P1.1 or equivalent
2	DIM-		
3,4	-V		
5,6	+V		

$\perp$  : Grounding required

## Block Diagram

fosc : 100KHz

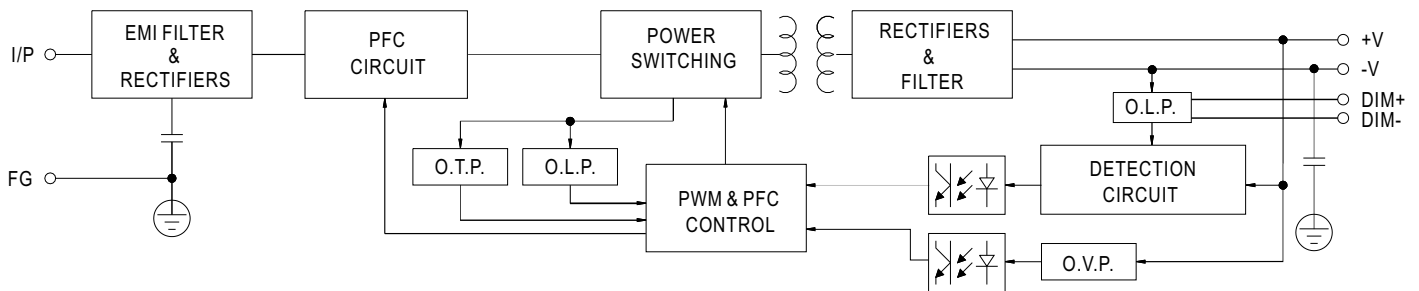

## Derating Curve

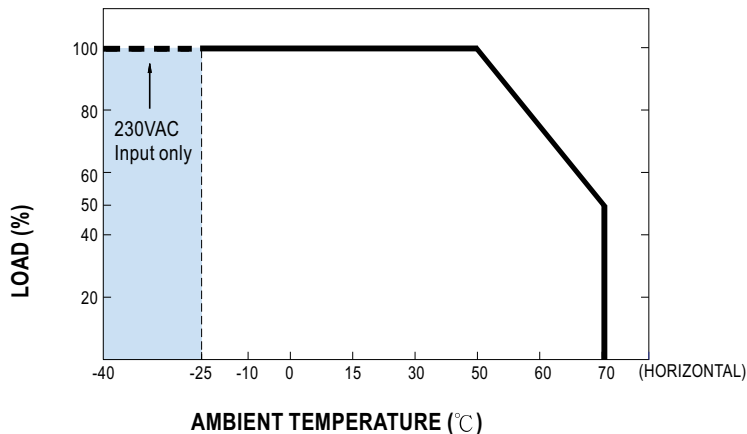

## Static Characteristics

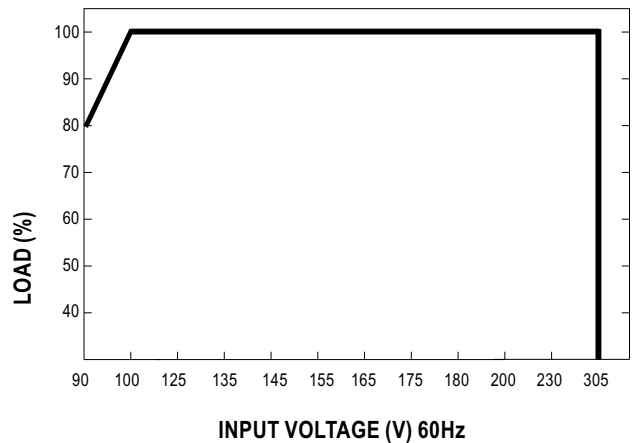

### Power Factor Characteristic

Constant Current Mode

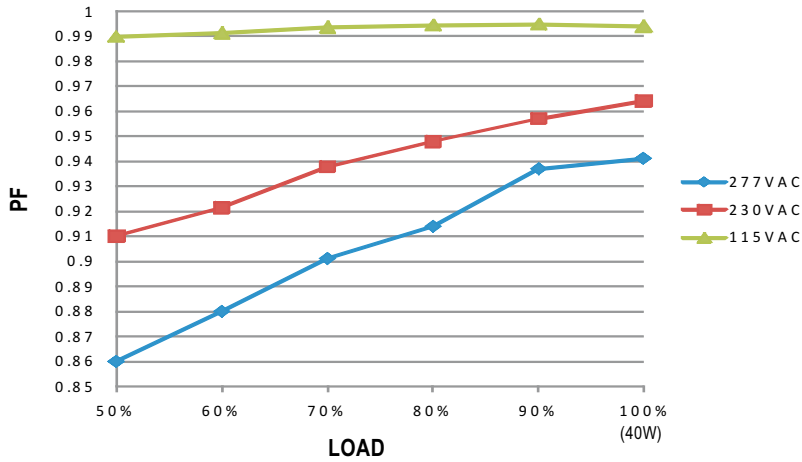

### EFFICIENCY vs LOAD (48V Model)

HLG-40H series possess superior working efficiency that up to 89.5% can be reached in field applications.

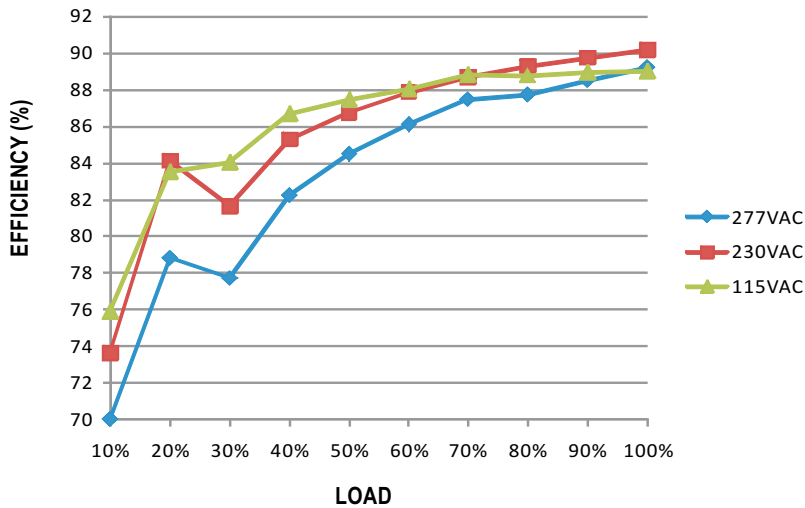

### DRIVING METHODS OF LED MODULE

There are two major kinds of LED drive method "direct drive" and "with LED driver".

A typical LED power supply may either work in "constant voltage mode (CV) or constant current mode (CC)" to drive the LEDs.

Mean Well's LED power supply with CV+ CC characteristic can be operated at both CV mode (with LED driver, at area (A) and CC mode (direct drive, at area (B)).

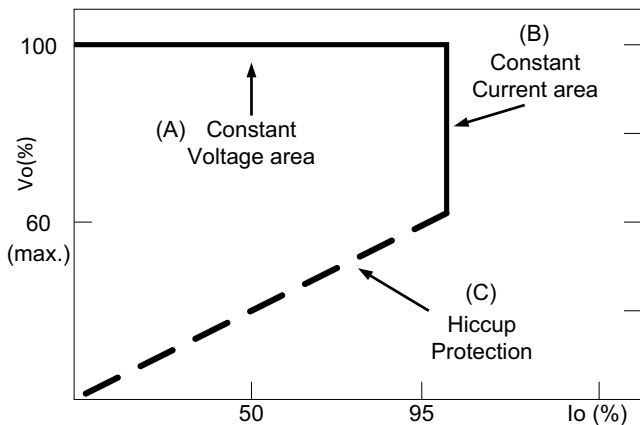

Typical LED power supply I-V curve

## DIMMING OPERATION

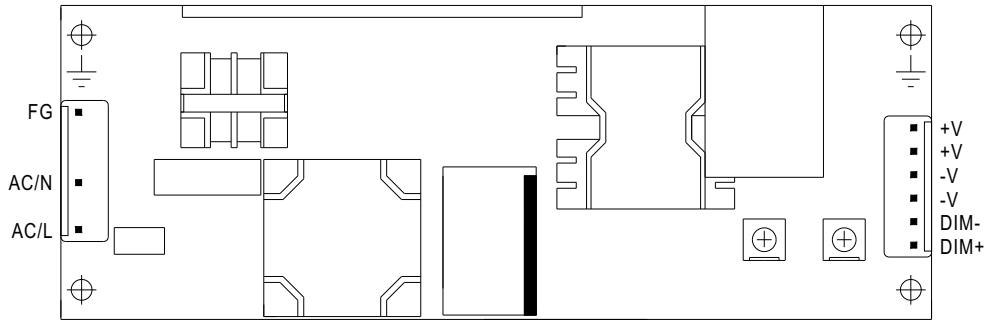

※ Output constant current level can be adjusted through output connector by 1~10VDC, PWM signal, or connecting a resistance between DIM+ and DIM-.

※ Please DO NOT connect "DIM-" to "-V".

※ Reference resistance value for output current adjustment (Typical)

Resistance value	Single driver	10KΩ	20KΩ	30KΩ	40KΩ	50KΩ	60KΩ	70KΩ	80KΩ	90KΩ	100KΩ	OPEN
	Multiple drivers (N=driver quantity for synchronized dimming operation)	10KΩ/N	20KΩ/N	30KΩ/N	40KΩ/N	50KΩ/N	60KΩ/N	70KΩ/N	80KΩ/N	90KΩ/N	100KΩ/N	-----
Percentage of rated current		10%	20%	30%	40%	50%	60%	70%	80%	90%	100%	95%~105%

※ 1 ~ 10V dimming function for output current adjustment (Typical)

Dimming value	1V	2V	3V	4V	5V	6V	7V	8V	9V	10V	OPEN
Percentage of rated current	10%	20%	30%	40%	50%	60%	70%	80%	90%	100%	95%~105%

※ 10V PWM signal for output current adjustment (Typical): Frequency range :100Hz ~ 3KHz

Duty value	10%	20%	30%	40%	50%	60%	70%	80%	90%	100%	OPEN
Percentage of rated current	10%	20%	30%	40%	50%	60%	70%	80%	90%	100%	95%~105%

※Using the built-in dimming function can't turn the lighting fixture totally dark. Please refer to the connection method below to achieve 0% brightness of the lighting fixture connecting to the LED power supply unit.

Dimming connection diagram for turning the lighting fixture ON/OFF :

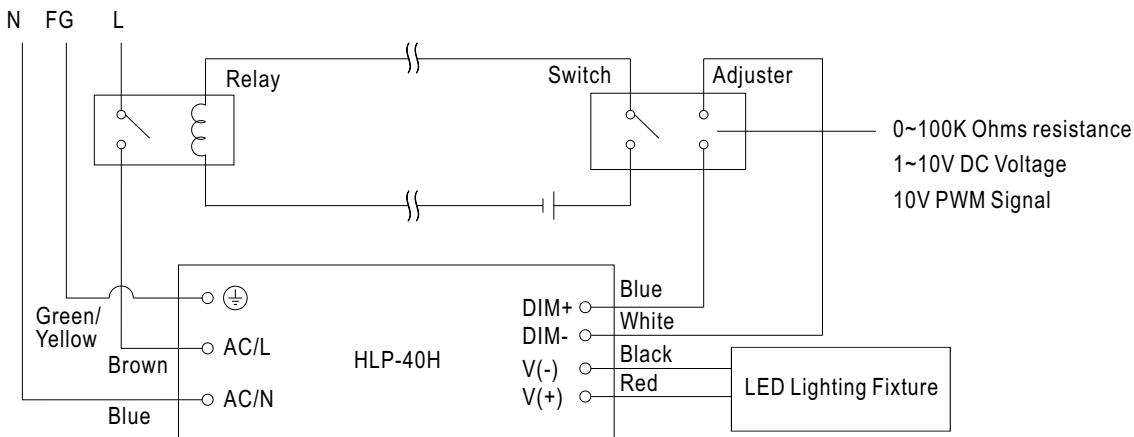

Using a switch and relay can turn ON/OFF the lighting fixture.

1. Output constant current level can be adjusted through output connector by connecting a resistance or 1~10Vdc or 10V PWM signal between DIM+ and DIM-.
2. The LED lighting fixture can be turned ON/OFF by the switch.