

## Data Sheet

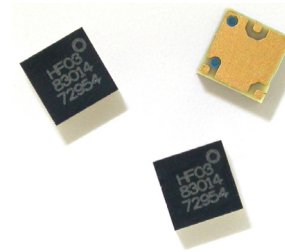

### Description

The Avago Technologies' ACMD-7403 is a miniature duplexer designed for use in UMTS Band II and PCS (Blocks A–F) handsets.

The ACMD-7403 enhances the sensitivity and dynamic range of handset receivers by providing more than 54 dB attenuation of the transmitted signal at the receiver input and more than 44 dB rejection of transmit-generated noise in the receive band.

Maximum Insertion Loss in the Tx channel is only 2.7 dB, which minimizes current drain from the power amplifier. Insertion Loss in the Rx channel is a maximum of 3.2 dB, thus improving receiver sensitivity.

The ACMD-7403 is designed with Avago Technologies' Film Bulk Acoustic Resonator (FBAR) technology, which makes possible ultra-small, high-Q filters at a fraction of their usual size. The excellent power handling capability of the FBAR bulk-mode resonators supports the high output power levels needed in PCS handsets while adding virtually no distortion.

The ACMD-7403 also utilizes Avago Technologies' innovative Microcap bonded-wafer, chip scale packaging technology. This process allows the filters to be assembled in a molded chip-on-board module that is less than 1.2 mm high with a footprint of only 3.0 mm x 3.0 mm.

### Features

- Miniature Size
  - 3.0 x 3.0 mm Max footprint
  - 1.2 mm Max height
- High Power Rating
  - 33 dBm Abs Max Tx Power
- Lead-Free Construction

### Specifications

- Rx Band Performance, 1930.5-1989.5 MHz, – 30 to +85°C
  - Rx Noise Blocking: 44 dB min
  - Insertion Loss: 3.2 dB max
- Tx Band Performance, 1850.5-1909.5 MHz, – 30 to +85°C
  - Tx Interferer Blocking: 52 dB min
  - Insertion Loss: 2.7 dB max

### Applications

Handsets or data terminals operating in the PCS (A–F) frequency band.

### Functional Block Diagram

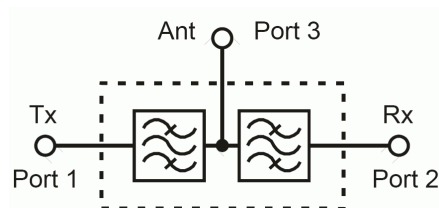

**ACMD-7403 Electrical Specifications** <sup>[2,3]</sup>,  $Z_0=50\ \Omega$ ,  $T_C$  <sup>[1]</sup> as indicated,

Symbol	Parameter	Units	-30°C			+25°C			+85°C		
			Min	Typ	Max	Min	Typ	Max	Min	Typ	Max
<b>Antenna Port to Receive Port</b>											
S23	Insertion Loss in Receive Band 1930.5 – 1931.5 MHz 1931.5 – 1989.5 MHz	dB			3.2 3.0		1.9 1.3	3.1 3.0			3.0 3.2
$\Delta$ S23	Ripple (p-p) in Receive Band	dB					1.7				
S22	Return Loss of Receive Port in Receive Band	dB	9.5			9.5	15		9.5		
S23	Attenuation in Transmit Band (1850.5 – 1909.5 MHz)	dB	52			52	59		52		
S23	Attenuation 0 – 1600 MHz	dB				20	29				
S23	Attenuation in Receive 2nd Harmonic Band (3861 – 3979 MHz)	dB				14	18				
<b>Transmit Port to Antenna Port</b>											
S31	Insertion Loss in Transmit Band 1850.5 – 1908.5 MHz 1908.5 – 1909.5 MHz	dB			2.5 2.5		1.0 1.4	2.1 2.3			2.5 2.7
$\Delta$ S31	Ripple (p-p) in Transmit Band	dB					1.3				
S11	Return Loss of Transmit Port in Transmit Band	dB	9.5			9.5	20		9.5		
S31	Attenuation in Receive Band (1930.5 – 1989.5 MHz)	dB	40			40	49		40		
S31	Attenuation 0 – 1600 MHz	dB				22	32				
S31	Attenuation in GPS Rx Band (1574.42 – 1576.42 MHz)	dB				23	27				
S31	Attenuation in Transmit 2nd Harmonic Band (3701 – 3819 MHz)	dB				5	9				
<b>Antenna Port</b>											
S33	Return Loss of Antenna Port in Receive Band (1930.5 – 1989.5 MHz)	dB	9			9	16		9		
S33	Return Loss of Antenna Port in Transmit Band (1850.5 – 1909.5 MHz)	dB	9			9	17		9		
<b>Isolation Transmit Port to Receive Port</b>											
S21	Tx-Rx Isolation in Receive Band (1930.5 – 1989.5 MHz)	dB	44			44	51		44		
S21	Tx-Rx Isolation in Transmit Band (1850.5 – 1909.5 MHz)	dB	54			54	61		54		

Notes:

$T_C$  is the case temperature and is defined as the temperature of the underside of the Duplexer where it makes contact with the circuit board.

Min/Max specifications are guaranteed at the indicated temperature with the input power to the Tx ports equal to or less than +29 dBm over all Tx frequencies unless otherwise noted. Typical data is the average value of the parameter over the indicated band at the specified temperature. Typical values may vary over time.

## ACMD-7403

### Absolute Maximum Ratings<sup>[1]</sup>

Parameter	Unit	Value
Storage temperature	°C	-65 to +125
Maximum RF Input Power to Tx Port	dBm	+33

### Maximum Recommended Operating Conditions<sup>[2]</sup>

Parameter	Unit	Value
Operating temperature, $T_C$ <sup>[3]</sup> , Tx Power $\leq$ 29 dBm	°C	-40 to +100
Operating temperature, $T_C$ <sup>[3]</sup> , Tx Power $\leq$ 30 dBm	°C	-40 to +85

#### Notes:

1. Operation in excess of any one of these conditions may result in permanent damage to the device.
2. The device will function over the recommended range without degradation in reliability or permanent change in performance, but is not guaranteed to meet electrical specifications.
3.  $T_C$  is defined as case temperature, the temperature of the underside of the duplexer where it makes contact with the circuit board.

### Characterization

A test circuit similar to the one shown in Figure 1 was used to measure typical device performance. This circuit is designed to interface with Air Coplanar (ACP), Ground-Signal-Ground (GSG) RF probes of the type commonly used to test semiconductor wafers. The PCB test circuit uses multiple vias to create a well-grounded pad to which the device under test (DUT) is solder-attached. Short lengths of 50-ohm microstripline connect the DUT to ACP probe patterns on the board.

A test circuit with ACMD-7403 mounted in place is shown in Figure 2. S-parameters are then measured using a network analyzer and calibrated ACP probe set.

Phase data for s-parameters measured with ACP probe circuits are adjusted to place the reference plane at the edge of the duplexer.

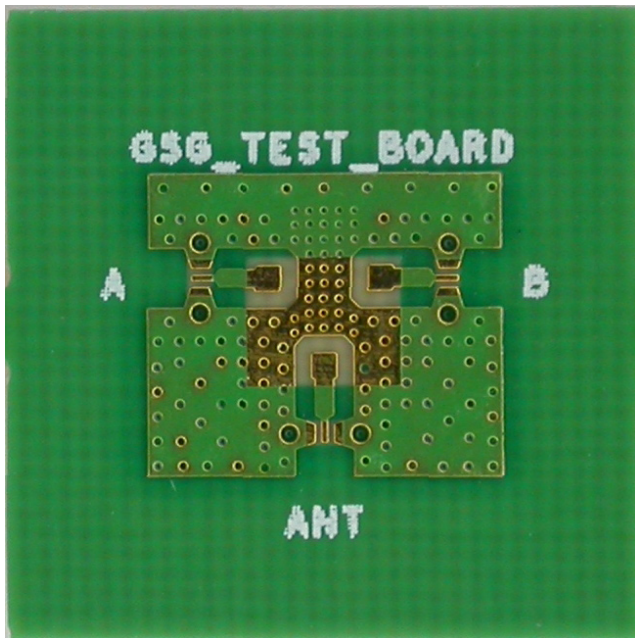

Figure 1. ACP Probe Test Circuit.

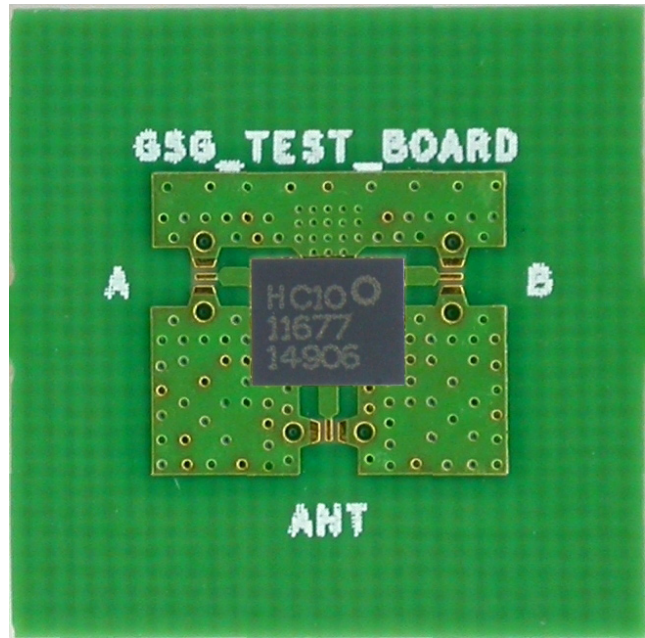

Figure 2. Test Circuit with Duplexer.

ACMD-7403 Typical Performance at  $T_c = 25^\circ\text{C}$

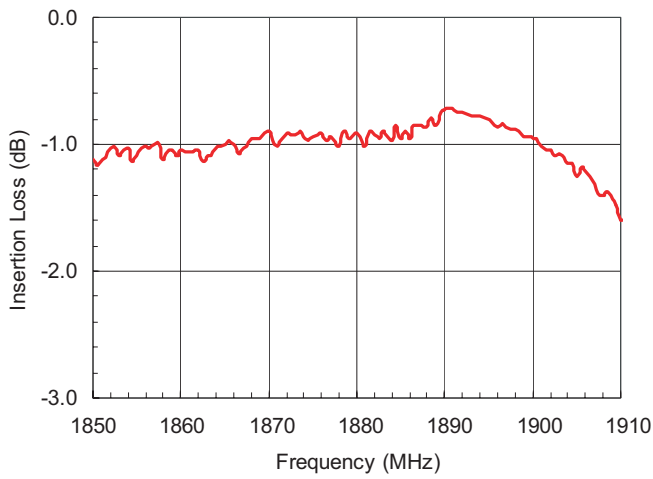

Figure 3.  $T_x$ -Ant Insertion Loss

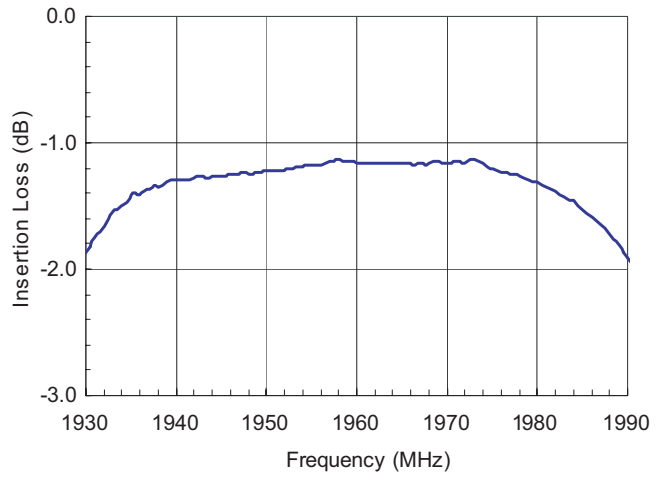

Figure 4. Ant- $R_x$  Insertion Loss

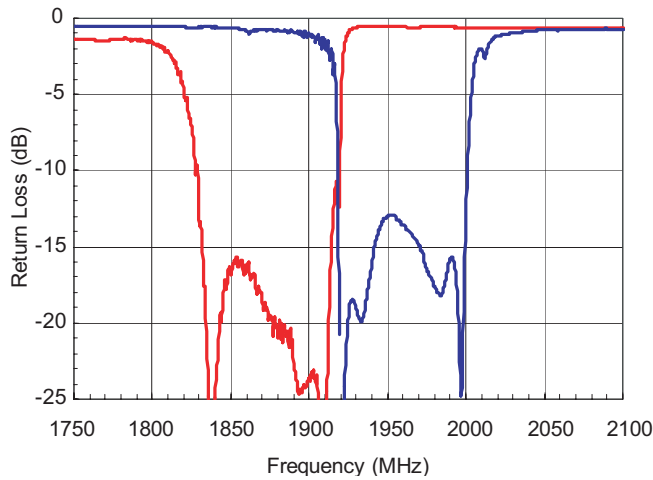

Figure 5.  $T_x$  and  $R_x$  Port Return Loss

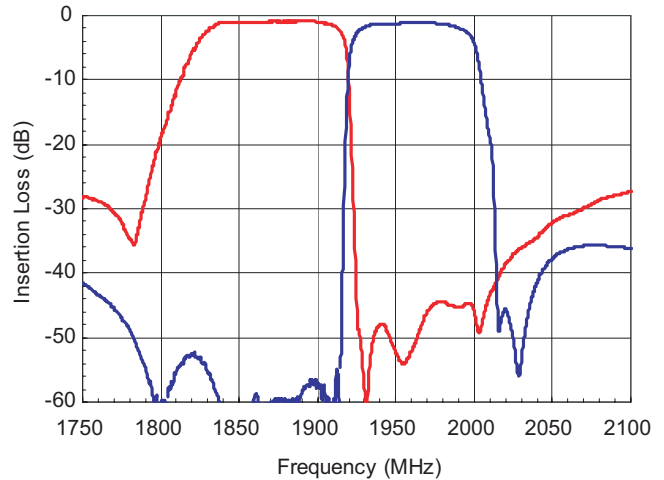

Figure 6.  $T_x$  Rejection in  $R_x$  Band and  $R_x$  Rejection in  $T_x$  Band

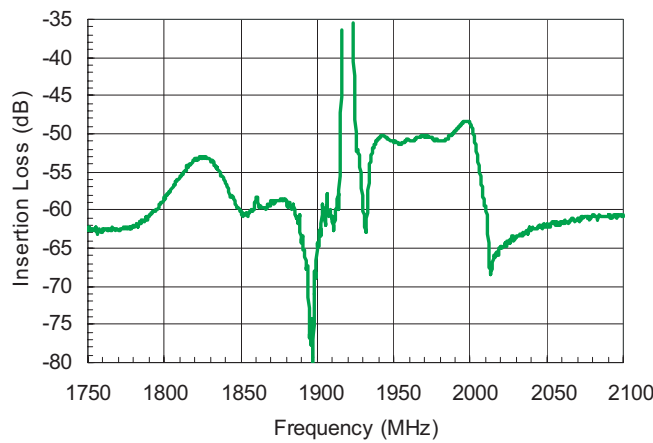

Figure 7.  $T_x$ - $R_x$  Isolation

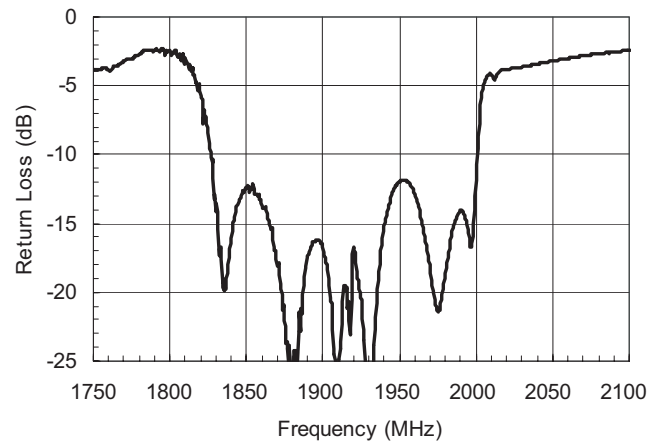

Figure 8. Antenna Port Return Loss

ACMD-7403 Typical Performance at  $T_c = 25^\circ\text{C}$

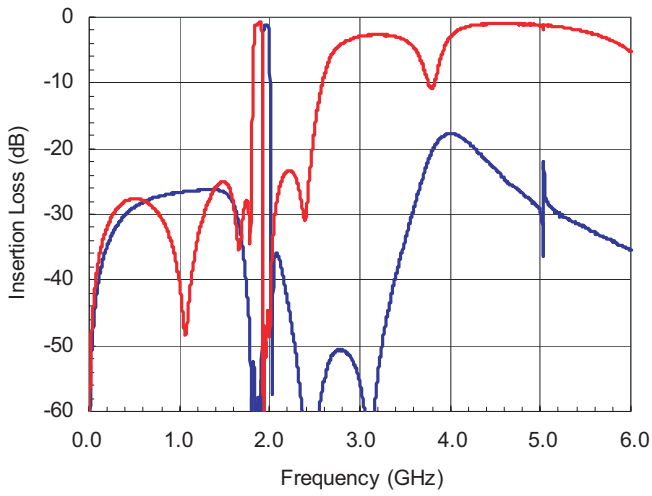

Figure 9.  $T_x$ -Ant and Ant- $R_x$  Wideband Insertion Loss

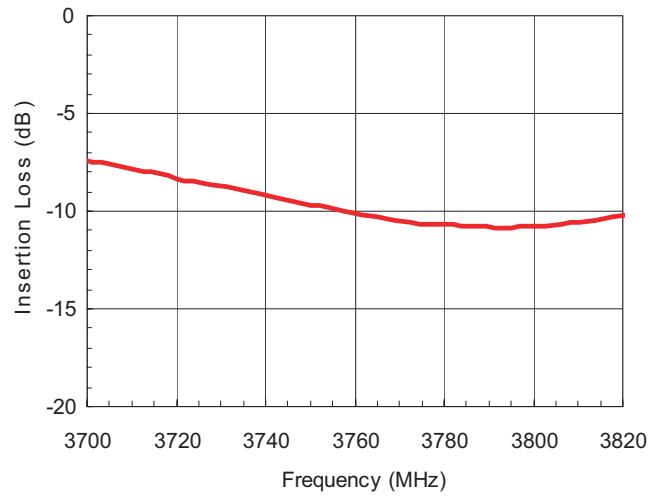

Figure 10.  $T_x$ -Ant Rejection at  $T_x$  Second Harmonic

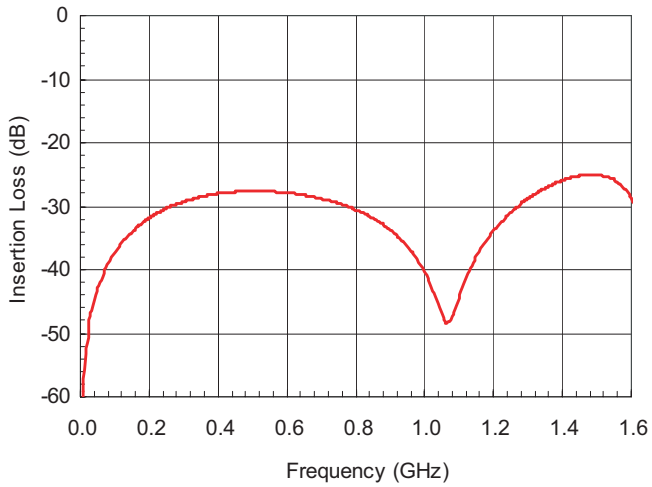

Figure 11.  $T_x$ -Ant Low Frequency Rejection

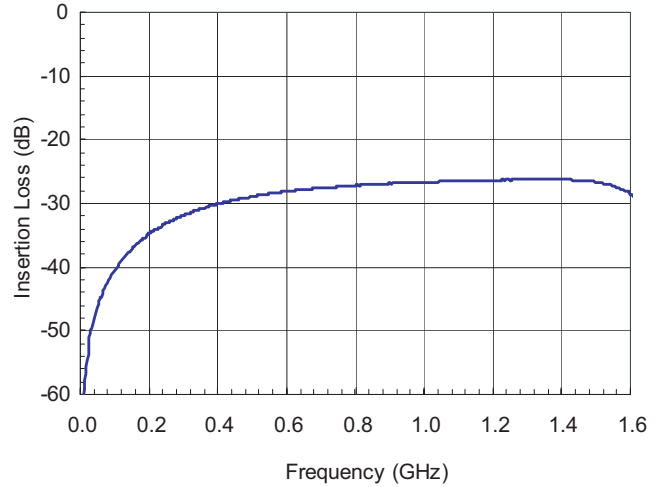

Figure 12. Ant- $R_x$  Low Frequency Rejection

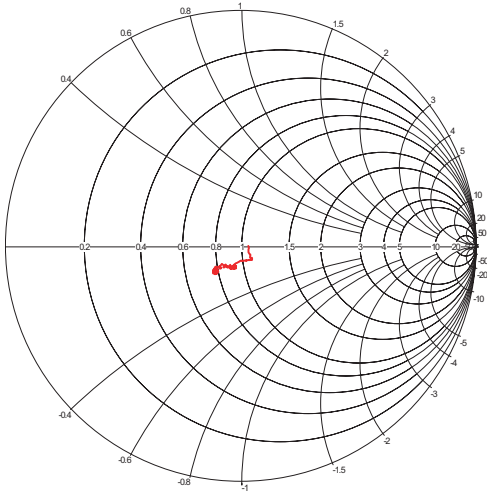

Figure 13.  $T_x$  Port Impedance in  $T_x$  Band

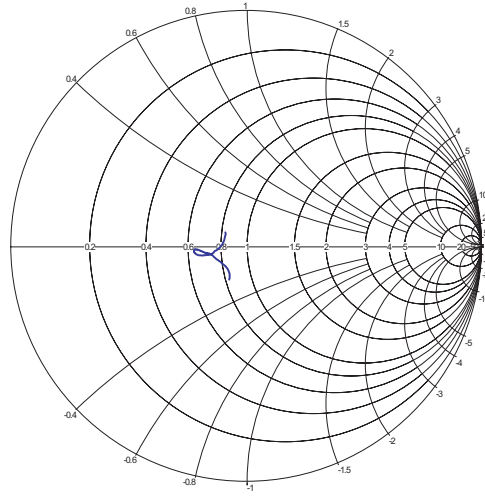

Figure 14.  $R_x$  Port Impedance in  $R_x$  Band

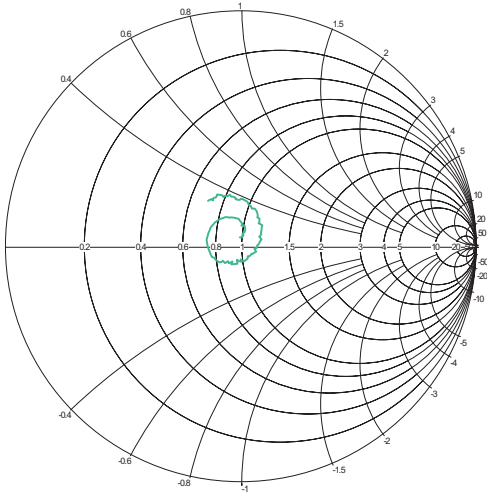

Figure 15. Ant Port Impedance in  $T_x$  Band

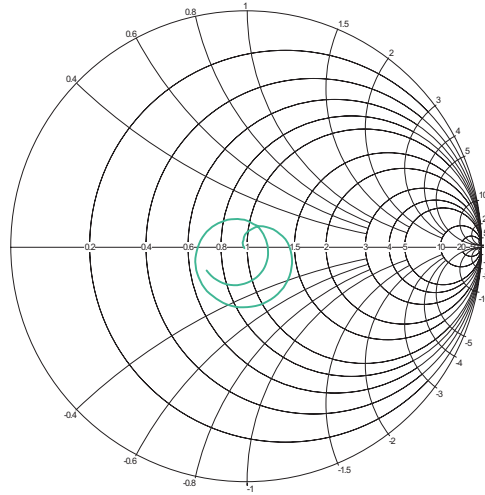

Figure 16. Ant Port Impedance in  $R_x$  Band

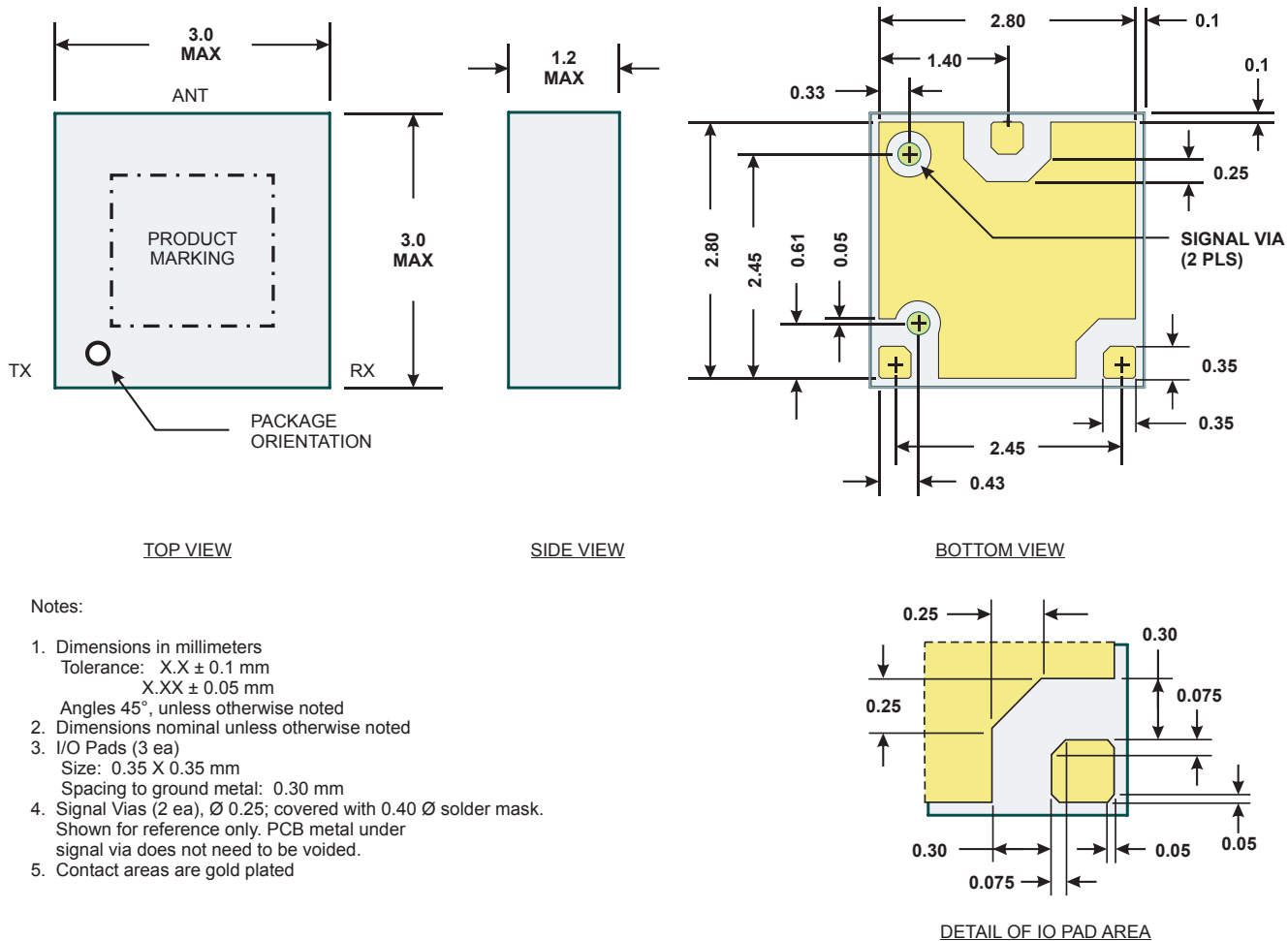

Figure 17. Package Outline Drawing

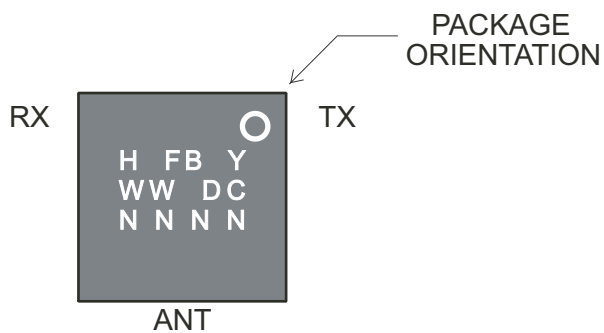
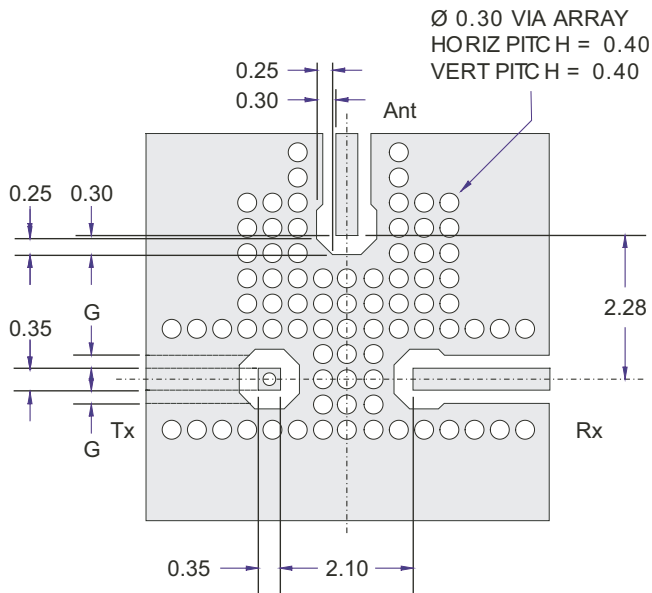

Figure 18. Product Marking

H = ACMD -7403  
 FB = Avago ID  
 Y = Year  
 WW = Work Week  
 DC = Date Code  
 NNNN = Lot Number





- Notes:
1. Dimensions in mm
  2. Transmission line Gap (G) adjusted for  $Z_0 = 50$  ohms
  3. I/O Pads (3 ea) 0.35 X 0.35, corner chamfer 0.03
  4. Ground vias positioned to maximize port-to-port isolation
  5. Preferred Tx connection on buried metal layer

**Figure 19. PCB Layout**

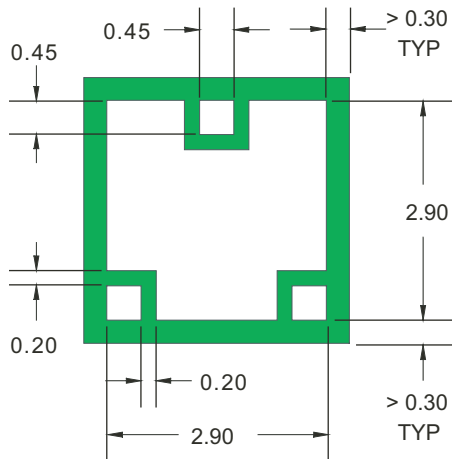

**Figure 21. Recommended Solder Mask**

A PCB layout using the principles illustrated in Figure 19 is recommended to optimize performance of the ACMD-7403.

It is particularly important to maximize isolation between the Tx connection to the duplexer and the Rx port. High isolation is achieved by: (1) maintaining a continuous ground plane around the duplexer mounting area, (2) surrounding the I/O ports with sufficient ground vias to enclose the connections in a “Faraday cage”, and (3) preferably routing the Tx trace in a different metal layer than the Rx.

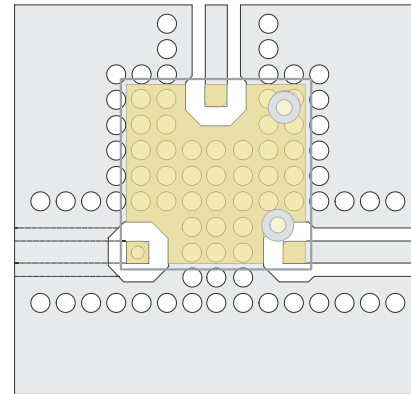

**Figure 20. ACMD-7403 Superposed on PCB Layout**

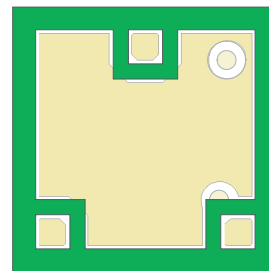

**Figure 22. ACMD-7403 Superposed on Solder Mask**

The latter is especially useful, not only to maintain Tx-Rx isolation of the duplexer, but also to prevent leakage of the Tx signal into other components that could result in the creation of intermodulation products and degradation of overall system performance.

A sufficient number of vias should be used to ensure excellent RF grounding as well as good heat sinking for the device.

Note:  
The two signal vias shown in Fig 17 are covered with solder mask and it is not necessary to void the ground plane under them.



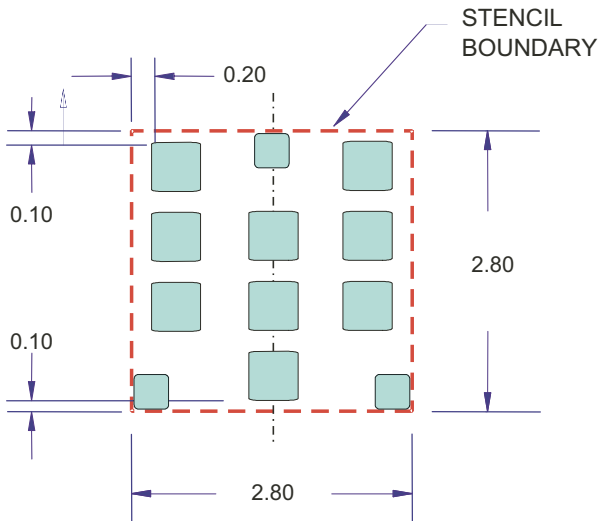

Stencil Opening ID	Qty	Width (mm)	Length (mm)
I/O pad areas	3	0.35	0.35
All other openings	9	0.50	0.50

Notes:

1. Chamfer or radius all corners 0.05 mm min
2. Stencil openings aligned to Boundary rectangle or center lines
3. Non-I/O pad stencil openings aligned to 0.52 x 0.55 grid (i.e., spacing between openings: 0.2 vertical, 0.5 horizontal)

Figure 23. Recommended Solder Stencil

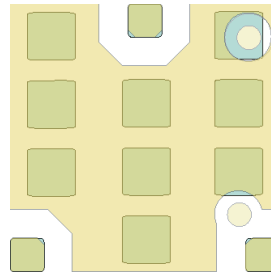
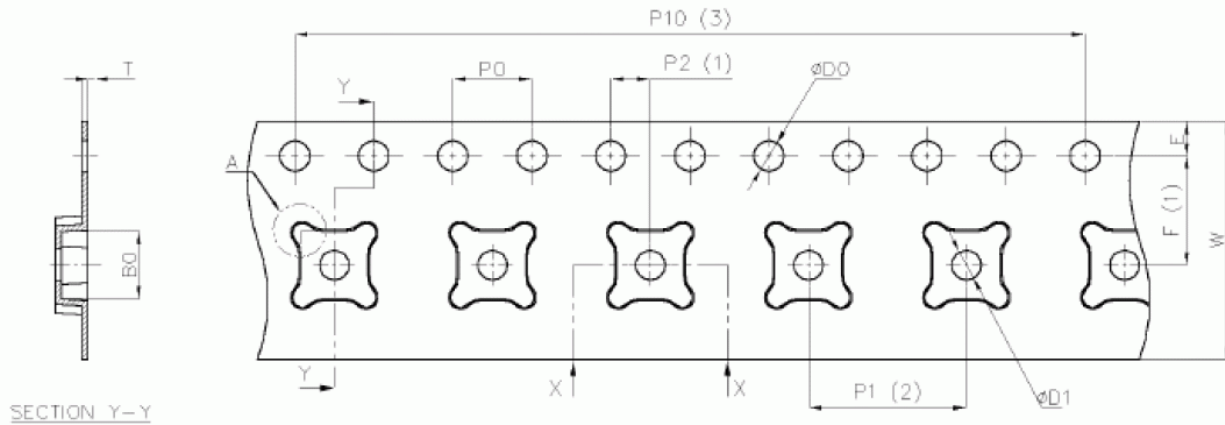
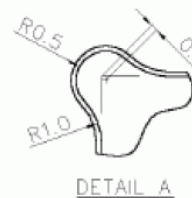
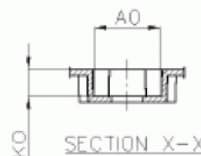

Figure 24. Solder Stencil Overlaid on ACMD-7403 Bottom Metal Pattern



SECTION Y-Y

Dimension List			
Annotate	Millimeter	Annotate	Millimeter
A0	3.40±0.10	P2	2.00±0.10
B0	3.40±0.10	P10	40.00±0.20
K0	1.35±0.10	E	1.75±0.10
D0	1.55±0.05	F	5.50±0.10
D1	1.60±0.10	W	12.00±0.30
P0	4.00±0.10	T	0.30±0.05
P1	8.00±0.10		



NOTE(S)

- 1) MEASURE FROM CENTERLINE OF SPROCKET HOLE TO CENTERLINE OF POCKET.
- 2) MEASURE FROM CENTERLINE OF POCKET TO CENTERLINE OF POCKET.
- 3) PITCH TOLERANCE FOR SPROCKET HOLE TO PITCH (CUMULATIVE TOLERANCE IS ±0.2mm).
- 4) ALLOWABLE CAMBER TO BE 1mm PER 250mm IN LENGTH.

Figure 25. SMD Tape Packing

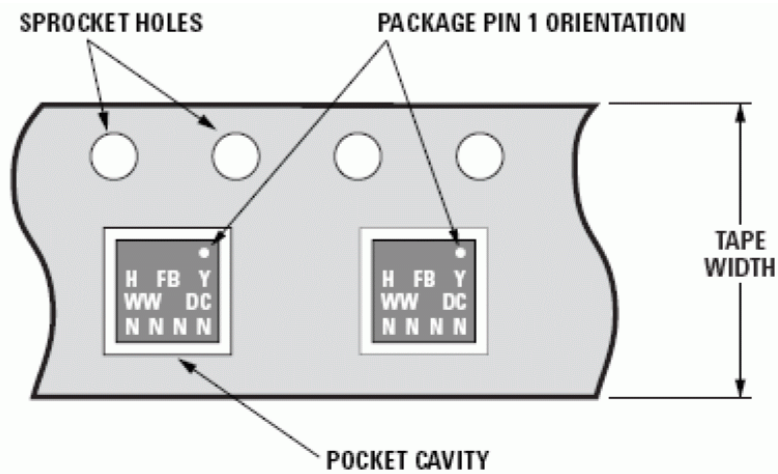

Figure 26. Unit Orientation in Tape

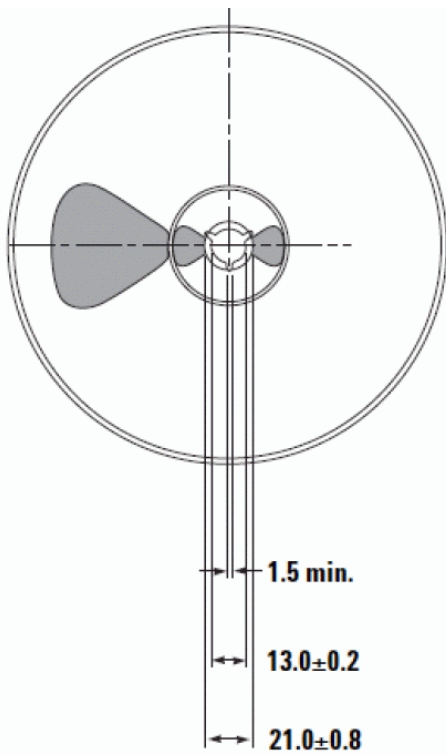

Figure 27. Reel Drawing, Front View

**NOTES:**

1. Reel shall be labeled with the following information (as a minimum).
  - a. manufacturers name or symbol
  - b. Agilent Technologies part number
  - c. purchase order number
  - d. date code
  - e. quantity of units
2. A certificate of compliance (c of c) shall be issued and accompany each shipment of product.
3. Reel must not be made with or contain ozone depleting materials.
4. All dimensions in millimeters (mm)

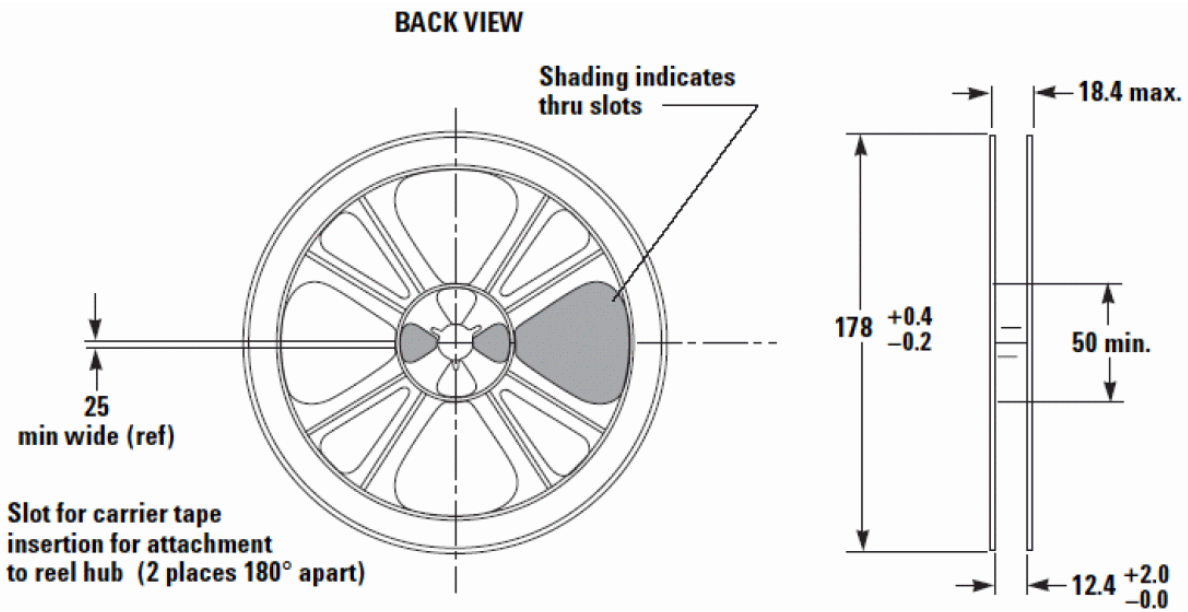

Figure 28. Reel Drawing, Back View

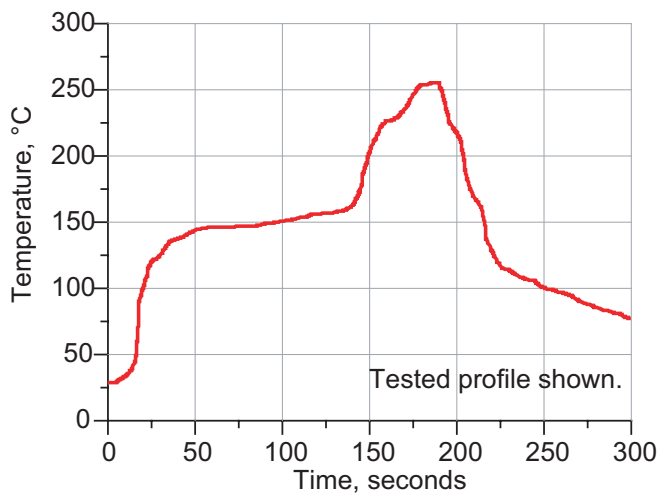

Figure 29. Verified SMT Solder Profile

#### Package Moisture Sensitivity

Feature	Test Method	Performance
Moisture Sensitivity Level (MSL) at 260°C	JESD22-A113D	Level 3

#### Ordering Information

Part Number	No. of Devices	Container
ACMD-7403-BLK	25	Anti-static Bag
ACMD-7403-TR1	1000	7-inch Reel

For product information and a complete list of distributors, please go to our web site: [www.avagotech.com](http://www.avagotech.com)

Avago, Avago Technologies, and the A logo are trademarks of Avago Technologies Limited in the United States and other countries. Data subject to change. Copyright © 2005-2008 Avago Technologies Limited. All rights reserved. AV02-0627EN - April 10, 2008

**AVAGO**  
TECHNOLOGIES