

# NCP439

## 2A Very Low Ron Switches at Low Vin Voltage

The NCP439 is a very low Ron MOSFET controlled by external logic pin, allowing optimization of battery life, and portable device autonomy.

This load switch is a best in class in term of  $R_{DS(on)}$  optimization at low  $V_{IN}$  voltage.

Due to a current consumption optimization with PMOS structure, leakage currents are eliminated by isolating connected IC's on the battery when not used.

Output discharge path is also embedded to eliminate residual voltages on the output.

Proposed in wide input voltage range from 1.0 V to 3.6 V, and a very small 0.96 x 0.96 mm WLCSP4, 0.5 mm pitch.

### Features

- 1 V – 3.6 V Operating Range
- 37 mΩ P MOSFET at 1.8 V
- DC Current Up to 2 A
- Output Auto-Discharge
- Active High EN Pin
- WLCSP4 0.96 x 0.96 mm
- This is a Pb-Free Device

### Typical Applications

- Mobile Phones
- Tablets
- Digital Cameras
- GPS
- Portable Devices



**ON Semiconductor®**

<http://onsemi.com>

### MARKING DIAGRAM



**WLCSP4  
CASE 567FG**

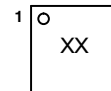

- XX = Specific Device Code
- A = Assembly Location
- WL = Wafer Lot
- YY = Year
- WW = Work Week
- G = Pb-Free Package

### PIN DIAGRAM

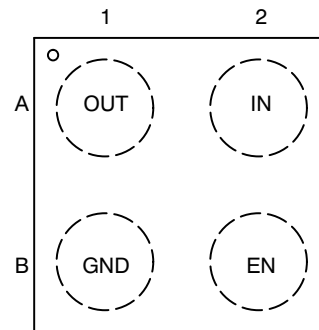

(Top View)

### ORDERING INFORMATION

See detailed ordering and shipping information on page 8 of this data sheet.

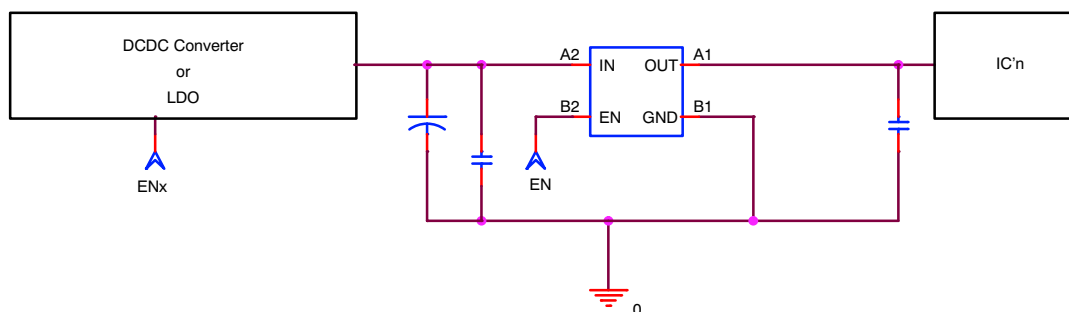

**Figure 1. Typical Application Circuit**

# NCP439

## PIN FUNCTION DESCRIPTION

Pin Name	Pin Number	Type	Description
IN	A2	POWER	Load-switch input voltage; connect a 0.1 $\mu$ F or greater ceramic capacitor from IN to GND as close as possible to the IC.
GND	B1	POWER	Ground connection.
EN	B2	INPUT	Enable input, logic high turns on power switch.
OUT	A1	OUTPUT	Load-switch output; connect a 0.1 $\mu$ F ceramic capacitor from OUT to GND as close as possible to the IC is recommended.

## BLOCK DIAGRAM

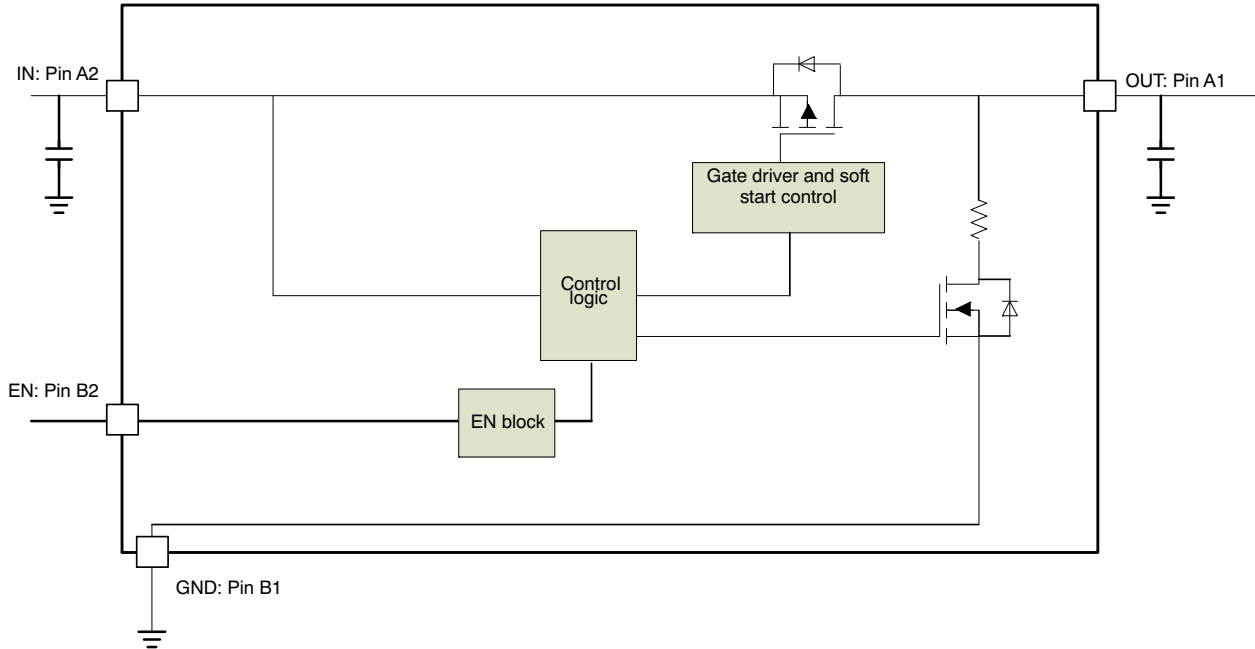

Figure 2. Block Diagram

# NCP439

## MAXIMUM RATINGS

Symbol	Rating	Value	Unit
$V_{EN}, V_{IN}, V_{OUT}$	IN, OUT, EN, Pins	-0.3 to + 4.0	V
$V_{IN}, V_{OUT}$	From IN to OUT Pins: Input/Output	0 to + 4.0	V
ESD HBM	Human Body Model (HBM) ESD Rating are (Notes 1 and 2)	2500	V
ESD MM	Machine Model (MM) ESD Rating are (Notes 1 and 2)	250	V
ESD CDM	Charge Device Model (CDM) ESD Rating are (Notes 1 and 2)	2000	V
LU	Latch-up protection (Note 3) - Pins IN, OUT, EN	100	mA
$T_J$	Maximum Junction Temperature	-40 to + 125	°C
$T_{STG}$	Storage Temperature Range	-40 to + 150	°C
MSL	Moisture Sensitivity (Note 4)	Level 1	

Stresses exceeding Maximum Ratings may damage the device. Maximum Ratings are stress ratings only. Functional operation above the Recommended Operating Conditions is not implied. Extended exposure to stresses above the Recommended Operating Conditions may affect device reliability.

- According to JEDEC standard JESD22-A108.
- This device series contains ESD protection and passes the following tests:  
Human Body Model (HBM)  $\pm 2.5$  kV per JEDEC standard: JESD22-A114 for all pins.  
Machine Model (MM)  $\pm 250$  V per JEDEC standard: JESD22-A115 for all pins.  
Charge Device Model (CDM)  $\pm 2.0$  kV per JEDEC standard: JESD22-C101 for all pins.
- Latch up Current Maximum Rating:  $\pm 100$  mA per JEDEC standard: JESD78 class II.
- Moisture Sensitivity Level (MSL): 1 per IPC/JEDEC standard: J-STD-020.

## OPERATING CONDITIONS

Symbol	Parameter	Conditions	Min	Typ	Max	Unit
$V_{IN}$	Operational Power Supply		1.0		3.6	V
$V_{EN}$	Enable Voltage		0		3.6	
$T_A$	Ambient Temperature Range		-40	25	+ 85	°C
$C_{IN}$	Decoupling input capacitor		0.1			$\mu$ F
$C_{OUT}$	Decoupling output capacitor		0.1			$\mu$ F
$R_{\theta JA}$	Thermal Resistance Junction to Air	WLCSP package (Note 5)		100		°C/W
$I_{OUT}$	Maximum DC current				2	A
$P_D$	Power Dissipation Rating (Note 6)	$T_A \leq 25^\circ\text{C}$	WLCSP package	0.5		W
		$T_A = 85^\circ\text{C}$	WLCSP package	0.2		

- The  $R_{\theta JA}$  is dependent of the PCB heat dissipation and thermal via.
- The maximum power dissipation ( $P_D$ ) is given by the following formula:

$$P_D = \frac{T_{JMAX} - T_A}{R_{\theta JA}}$$

# NCP439

**ELECTRICAL CHARACTERISTICS** Min and Max Limits apply for  $T_A$  between  $-40^{\circ}\text{C}$  to  $+85^{\circ}\text{C}$  for  $V_{IN}$  between 1.0 V to 3.6 V (Unless otherwise noted). Typical values are referenced to  $T_A = +25^{\circ}\text{C}$  and  $V_{IN} = 3.3\text{ V}$  (Unless otherwise noted).

Symbol	Parameter	Conditions	Min	Typ	Max	Unit	
<b>POWER SWITCH</b>							
$R_{DS(on)}$	Static drain-source on-state resistance	$V_{IN} = 3.6\text{ V}$	$T_A = 25^{\circ}\text{C}$		27	34	m $\Omega$
			$T_J = 125^{\circ}\text{C}$			38	
		$V_{IN} = 3.3\text{ V}$	$T_A = 25^{\circ}\text{C}$		28	35	
			$T_J = 125^{\circ}\text{C}$			40	
		$V_{IN} = 2.5\text{ V}$	$T_A = 25^{\circ}\text{C}$		31	39	
			$T_J = 125^{\circ}\text{C}$			45	
		$V_{IN} = 1.8\text{ V}$	$T_A = 25^{\circ}\text{C}$		37	45	
			$T_J = 125^{\circ}\text{C}$			52	
		$V_{IN} = 1.2\text{ V}$	$T_A = 25^{\circ}\text{C}$		54	70	
			$T_J = 125^{\circ}\text{C}$			76	
$R_{DIS}$	Output discharge path	EN = low	$V_{IN} = 3.3\text{ V}$	55	67	95	$\Omega$

## TIMINGS

$T_R$	Output rise time	$V_{IN} = 3.3\text{ V}$	$C_{LOAD} = 1\ \mu\text{F}$ , $R_{LOAD} = 25\ \Omega$ From 10% to 90% of $V_{OUT}$	40	75	160	$\mu\text{s}$
$T_F$	Output fall time		$C_{LOAD} = 1\ \mu\text{F}$ , $R_{LOAD} = 25\ \Omega$ (Note 7)	10	50	80	$\mu\text{s}$
$T_{dis}$	Disable time		From EN vil to 90% $V_{OUT}$		8.7		$\mu\text{s}$
$T_{on}$	Gate turn on		Enable time + Output rise time	70	166	280	$\mu\text{s}$
$T_{en}$	Enable time		From EN low to high to $V_{OUT} = 10\%$ of fully on	30	66	120	$\mu\text{s}$

## LOGIC PIN

$V_{IH}$	High-level input voltage	$V_{IN} = 3.3\text{ V}$		0.90			V
$V_{IL}$	Low-level input voltage	$V_{IN} = 3.3\text{ V}$				0.5	V

## QUIESCENT CURRENT

$I_Q$	Current consumption	$V_{IN} = 3.3\text{ V}$ , EN = low, No load			0.02	1	$\mu\text{A}$
		$V_{IN} = 3.3\text{ V}$ , EN = high, No load			1.6	4	

7. Parameters are guaranteed for  $C_{LOAD}$  and  $R_{LOAD}$  connected to the OUT pin with respect to the ground  
 8. Guaranteed by design and characterization, not production tested.

# NCP439

## TIMINGS

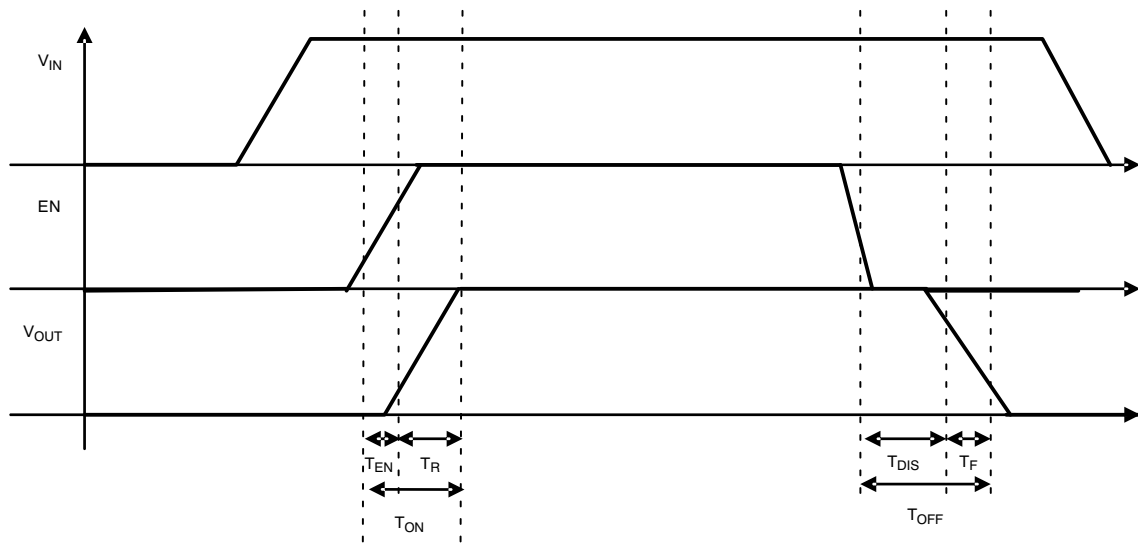

Figure 3. Enable, Rise and fall time

# NCP439

## TYPICAL CHARACTERISTICS

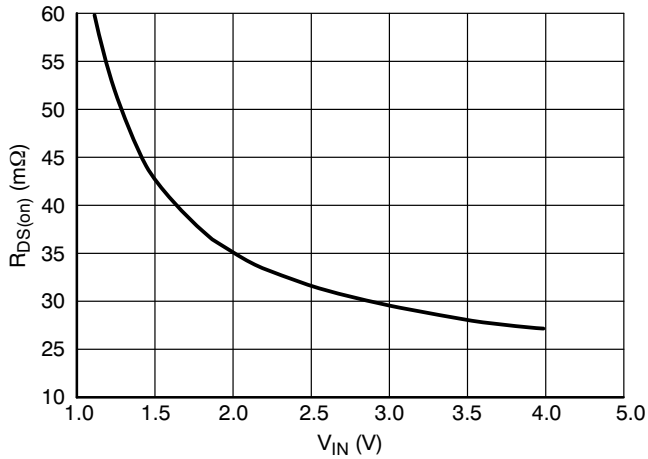

Figure 4. R<sub>DS(on)</sub> (mΩ) vs V<sub>IN</sub> (V), No Load

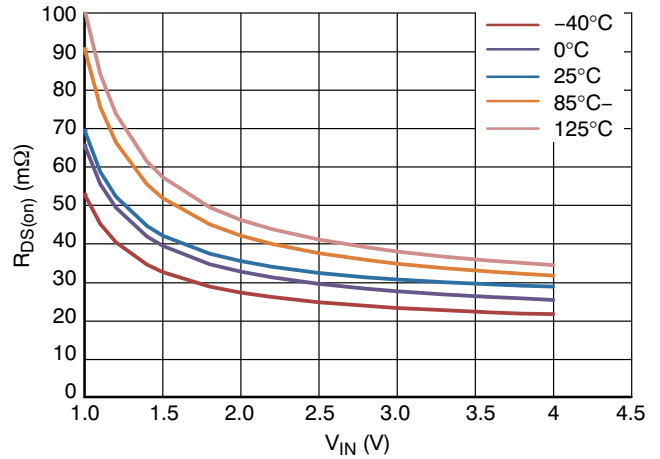

Figure 5. R<sub>DS(on)</sub> (mΩ) vs V<sub>IN</sub> (V) In Temperature (°C), No Load

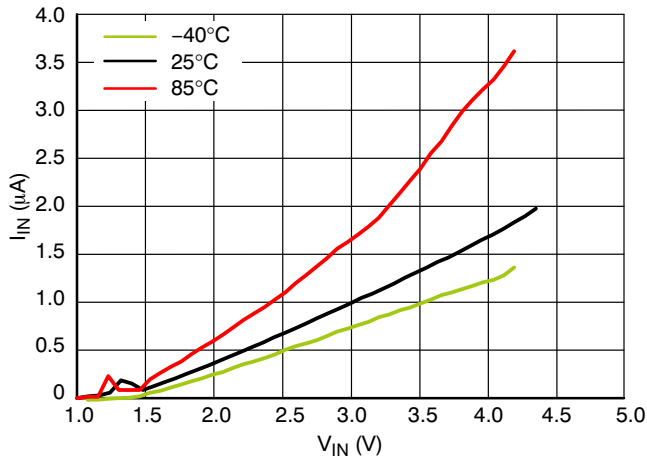

Figure 6. Quiescent Current (μA) vs V<sub>IN</sub> (V), In Temperature

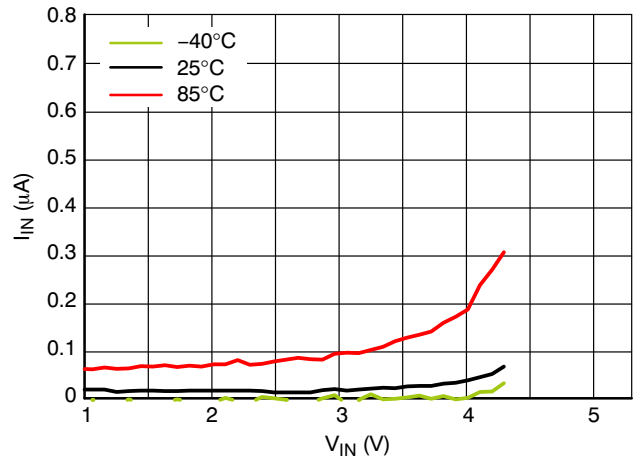

Figure 7. Standby Current (μA) vs V<sub>IN</sub> (V), In Temperature

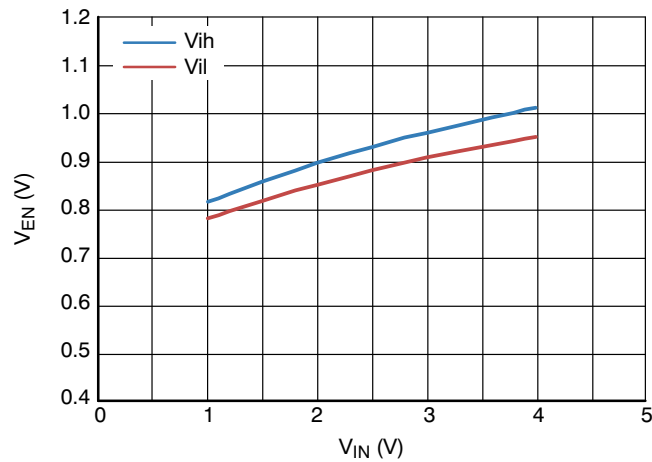

Figure 8. Enable Logic Threshold vs V<sub>IN</sub>

# NCP439

## FUNCTIONAL DESCRIPTION

### Overview

The NCP439 is high side P channel MOSFET power distribution switch designed to isolate ICs connected on the battery in order to save energy. The part can be turned on, with a range of battery from 1.0 V to 3.6 V.

### Enable input

Enable pin is an active high. The path is opened when EN pin is tied low (disable), forcing P MOS switch off.

The IN/OUT path is activated with a minimum of  $V_{IN}$  of 1.0 V and EN forced to high level.

### Auto Discharge

N-MOSFET is placed between the output pin and GND, in order to discharge the application capacitor connected on OUT pin.

The auto-discharge is activated when EN pin is set to low level (disable state).

The discharge path ( Pull down NMOS) stays activated as long as EN pin is set at low level and  $V_{IN} > 1.0$  V.

In order to limit the current across the internal discharge N-MOSFET, the typical value is set at 65  $\Omega$ .

### $C_{IN}$ and $C_{OUT}$ Capacitors

IN and OUT, 100 nF, at least, capacitors must be placed as close as possible the part for stability improvement.

## APPLICATION INFORMATION

### Power Dissipation

Main contributor in term of junction temperature is the power dissipation of the power MOSFET. Assuming this, the power dissipation and the junction temperature in normal mode can be calculated with the following equations:

$$P_D = R_{DS(on)} \times (I_{OUT})^2$$

$P_D$  = Power dissipation (W)  
 $R_{DS(on)}$  = Power MOSFET on resistance ( $\Omega$ )  
 $I_{OUT}$  = Output current (A)

$$T_J = P_D \times R_{\theta JA} + T_A$$

$T_J$  = Junction temperature ( $^{\circ}C$ )  
 $R_{\theta JA}$  = Package thermal resistance ( $^{\circ}C/W$ )  
 $T_A$  = Ambient temperature ( $^{\circ}C$ )

### PCB Recommendations

The NCP439 integrates an up to 2 A rated PMOS FET, and the PCB design rules must be respected to properly evacuate the heat out of the silicon. By increasing PCB area, especially around IN and OUT pins, the  $R_{\theta JA}$  of the package can be decreased, allowing higher power dissipation.

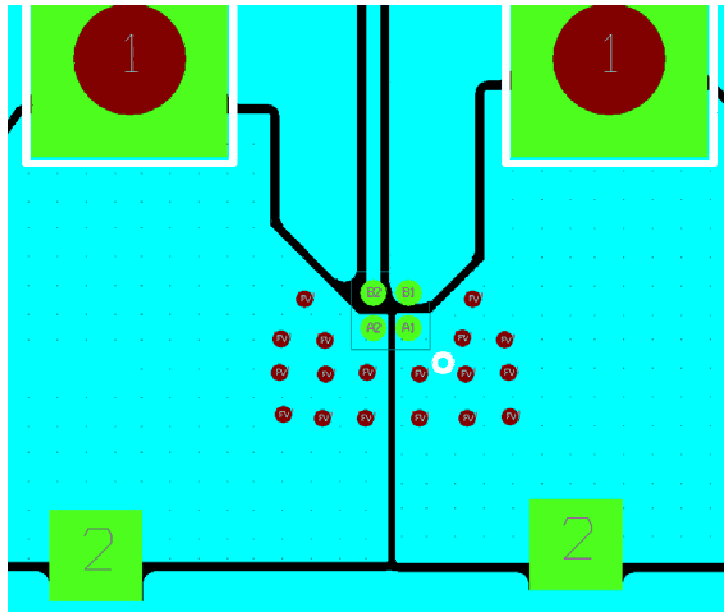

Figure 9. Routing Example 1 oz, 2 Layers, 100 $^{\circ}C/W$

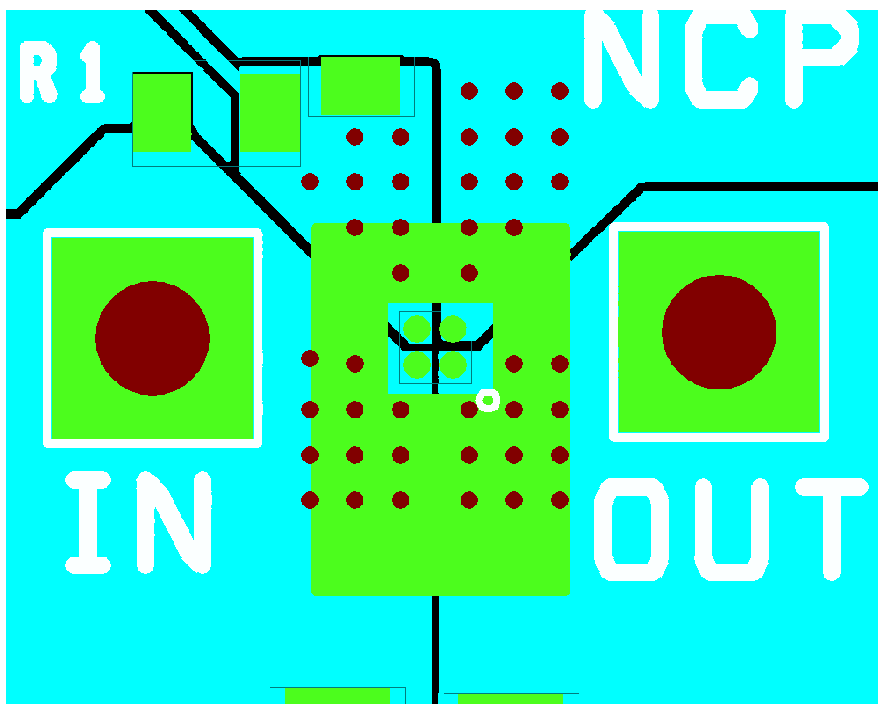

Figure 10. Routing Example 2 oz, 4 Layers, 60°C/W

**ORDERING INFORMATION**

Device	Auto Discharge	Marking	Package	Shipping†
NCP439FCT2G	Yes	AY	WLCSP 0.96 x 0.96 mm (Pb-Free)	3000 / Tape & Reel

†For information on tape and reel specifications, including part orientation and tape sizes, please refer to our Tape and Reel Packaging Specifications Brochure, BRD8011/D.



# NCP439

## PACKAGE DIMENSIONS

WLCSP4, 0.96x0.96  
CASE 567FG  
ISSUE O

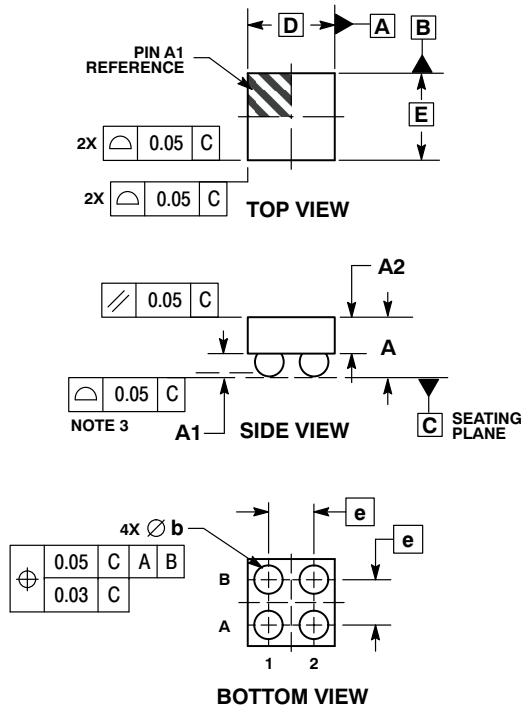

NOTES:

1. DIMENSIONING AND TOLERANCING PER ASME Y14.5M, 1994.
2. CONTROLLING DIMENSION: MILLIMETERS.
3. COPLANARITY APPLIES TO SPHERICAL CROWNS OF SOLDER BALLS.

MILLIMETERS		
DIM	MIN	MAX
A	0.54	0.63
A1	0.22	0.28
A2	0.33 REF	
b	0.29	0.34
D	0.96 BSC	
E	0.96 BSC	
e	0.50 BSC	

### RECOMMENDED SOLDERING FOOTPRINT\*

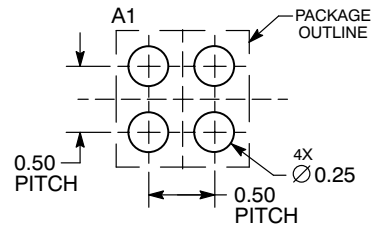

DIMENSIONS: MILLIMETERS

\*For additional information on our Pb-Free strategy and soldering details, please download the ON Semiconductor Soldering and Mounting Techniques Reference Manual, SOLDERRM/D.

ON Semiconductor and are registered trademarks of Semiconductor Components Industries, LLC (SCILLC). SCILLC owns the rights to a number of patents, trademarks, copyrights, trade secrets, and other intellectual property. A listing of SCILLC's product/patent coverage may be accessed at [www.onsemi.com/site/pdf/Patent-Marking.pdf](http://www.onsemi.com/site/pdf/Patent-Marking.pdf). SCILLC reserves the right to make changes without further notice to any products herein. SCILLC makes no warranty, representation or guarantee regarding the suitability of its products for any particular purpose, nor does SCILLC assume any liability arising out of the application or use of any product or circuit, and specifically disclaims any and all liability, including without limitation special, consequential or incidental damages. "Typical" parameters which may be provided in SCILLC data sheets and/or specifications can and do vary in different applications and actual performance may vary over time. All operating parameters, including "Typicals" must be validated for each customer application by customer's technical experts. SCILLC does not convey any license under its patent rights nor the rights of others. SCILLC products are not designed, intended, or authorized for use as components in systems intended for surgical implant into the body, or other applications intended to support or sustain life, or for any other application in which the failure of the SCILLC product could create a situation where personal injury or death may occur. Should Buyer purchase or use SCILLC products for any such unintended or unauthorized application, Buyer shall indemnify and hold SCILLC and its officers, employees, subsidiaries, affiliates, and distributors harmless against all claims, costs, damages, and expenses, and reasonable attorney fees arising out of, directly or indirectly, any claim of personal injury or death associated with such unintended or unauthorized use, even if such claim alleges that SCILLC was negligent regarding the design or manufacture of the part. SCILLC is an Equal Opportunity/Affirmative Action Employer. This literature is subject to all applicable copyright laws and is not for resale in any manner.

### PUBLICATION ORDERING INFORMATION

**LITERATURE FULFILLMENT:**

Literature Distribution Center for ON Semiconductor  
P.O. Box 5163, Denver, Colorado 80217 USA

Phone: 303-675-2175 or 800-344-3860 Toll Free USA/Canada

Fax: 303-675-2176 or 800-344-3867 Toll Free USA/Canada

Email: [orderlit@onsemi.com](mailto:orderlit@onsemi.com)

**N. American Technical Support:** 800-282-9855 Toll Free  
USA/Canada

**Europe, Middle East and Africa Technical Support:**

Phone: 421 33 790 2910

**Japan Customer Focus Center**

Phone: 81-3-5817-1050

**ON Semiconductor Website:** [www.onsemi.com](http://www.onsemi.com)

**Order Literature:** <http://www.onsemi.com/orderlit>

For additional information, please contact your local Sales Representative