



# ES1AF THRU ES1JF

## SURFACE MOUNT SUPER FAST RECTIFIER

Reverse Voltage - 50 to 600 Volts Forward Current - 1.0 Ampere

### SMAF

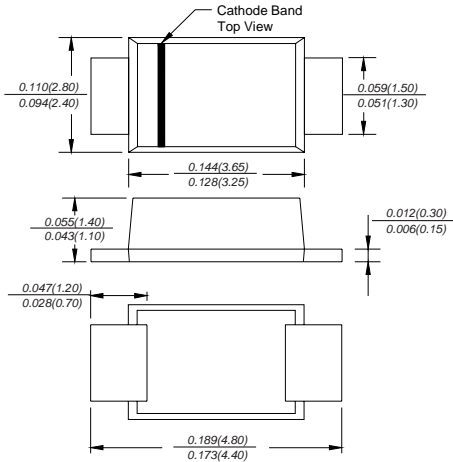

Dimensions in inches and (millimeters)

### FEATURES

- ◆ The plastic package carries Underwriters Laboratory Flammability Classification 94V-0
- ◆ For surface mounted applications
- ◆ Super fast switching for high efficiency
- ◆ Low reverse leakage
- ◆ Built-in strain relief, ideal for automated placement
- ◆ High forward surge current capability
- ◆ High temperature soldering guaranteed: 260°C/10 seconds at terminals
- ◆ Glass passivated chip junction

### MECHANICAL DATA

**Case:** JEDEC SMAF molded plastic body over passivated chip

**Terminals:** Solder plated, solderable per MIL-STD-750, Method 2026

**Polarity:** Color band denotes cathode end

**Mounting Position:** Any

**Weight:** 0.0018 ounce, 0.064 grams

### MAXIMUM RATINGS AND ELECTRICAL CHARACTERISTICS

Ratings at 25°C ambient temperature unless otherwise specified.

Single phase half-wave 60Hz, resistive or inductive load, for capacitive load current derate by 20%.

MDD Catalog Number	SYMBOLS	ES1AF	ES1BF	ES1CF	ES1DF	ES1EF	ES1GF	ES1JF	UNITS
Maximum repetitive peak reverse voltage	$V_{RRM}$	50	100	150	200	300	400	600	VOLTS
Maximum RMS voltage	$V_{RMS}$	35	70	105	140	210	280	420	VOLTS
Maximum DC blocking voltage	$V_{DC}$	50	100	150	200	300	400	600	VOLTS
Maximum average forward rectified current at $T_L=55^\circ\text{C}$	$I_{(AV)}$	1.0							Amp
Peak forward surge current 8.3ms single half sine-wave superimposed on rated load (JEDEC Method)	$I_{FSM}$	30.0							Amps
Maximum instantaneous forward voltage at 1.0A	$V_F$	0.95			1.25		1.7		Volts
Maximum DC reverse current at rated DC blocking voltage $T_A=25^\circ\text{C}$ $T_A=100^\circ\text{C}$	$I_R$	5.0 50.0							$\mu\text{A}$
Maximum reverse recovery time (NOTE 1)	$t_{rr}$	35							ns
Typical junction capacitance (NOTE 2)	$C_J$	15.0							pF
Typical thermal resistance (NOTE 3)	$R_{\theta JA}$	60.0							$^\circ\text{C/W}$
Operating junction and storage temperature range	$T_J, T_{STG}$	-50 to +150							$^\circ\text{C}$

**Note:** 1. Reverse recovery condition  $I_F=0.5\text{A}, I_R=1.0\text{A}, I_{rr}=0.25\text{A}$

2. Measured at 1MHz and applied reverse voltage of 4.0V D.C.

3. P.C.B. mounted with 0.2x0.2" (5.0x5.0mm) copper pad areas

# RATINGS AND CHARACTERISTIC CURVES ES1AF THRU ES1JF

AVERAGE FORWARD RECTIFIED CURRENT,  
AMPERES

FIG. 1- FORWARD CURRENT DERATING CURVE

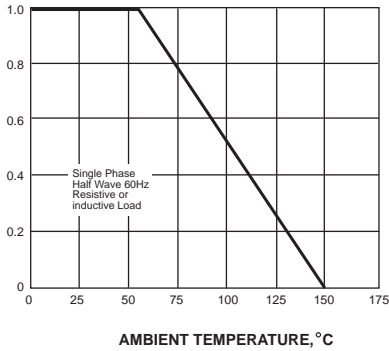

PEAK FORWARD SURGE CURRENT,  
AMPERES

FIG. 2-MAXIMUM NON-REPETITIVE PEAK FORWARD SURGE CURRENT

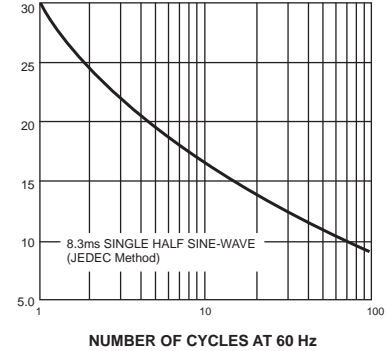

INSTANTANEOUS FORWARD CURRENT, AMPERES

FIG. 3-TYPICAL INSTANTANEOUS FORWARD CHARACTERISTICS

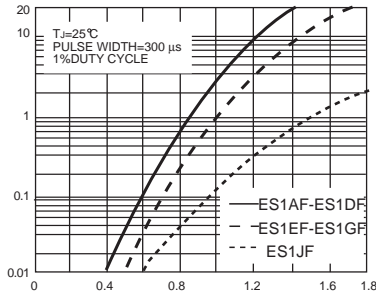

INSTANTANEOUS FORWARD VOLTAGE,  
VOLTS

INSTANTANEOUS REVERSE CURRENT,  
MICROAMPERES

FIG. 4-TYPICAL REVERSE CHARACTERISTICS

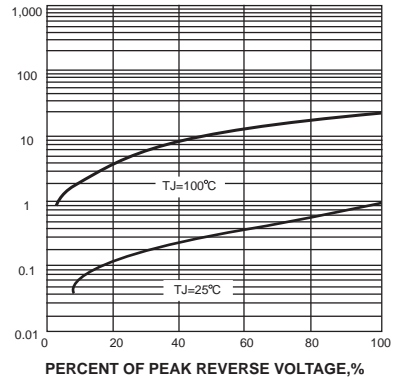

PERCENT OF PEAK REVERSE VOLTAGE, %

JUNCTION CAPACITANCE, pF

FIG. 5-TYPICAL JUNCTION CAPACITANCE

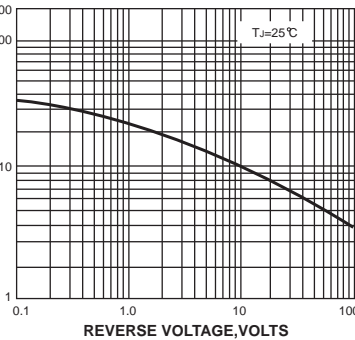

REVERSE VOLTAGE, VOLTS

TRANSIENT THERMAL IMPEDANCE,  
°C/W

FIG. 6-TYPICAL TRANSIENT THERMAL IMPEDANCE

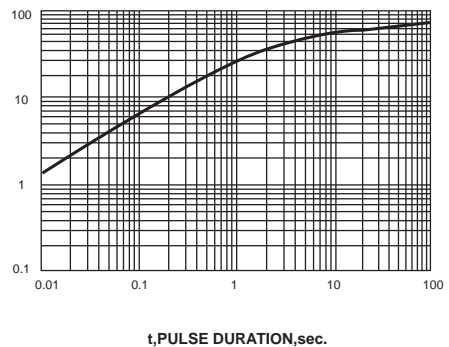

t, PULSE DURATION, sec.