

**SECONDARY SIDE SYNCHRONOUS RECTIFICATION SWITCHER**

NEW PRODUCT

**Description**

APR34309C is a secondary side Combo IC, which combines an N-Channel MOSFET and a driver circuit designed for synchronous rectification (SR) in DCM operation. It also integrates output voltage detect function for primary side control system.

The N-Channel MOSFET has been optimized for low gate charge, low  $R_{DS(ON)}$ , fast switching speed and body diode reverse recovery performance.

The synchronous rectification can effectively reduce the secondary side rectifier power dissipation and provide high performance solution. By sensing MOSFET drain-to-source voltage, APR34309C can output ideal drive signal with less external components. It can provide high performance solution for 5V output voltage application.

Same as AP4341, APR34309C detects the output voltage and provides a periodical signal when the output voltage is lower than a certain threshold. By fast response to secondary side voltage, APR34309C can effectively improve the transient performance of primary side control system.

The APR34309C is available in SO-8EP package.

**Features**

- Synchronous Rectification for DCM Operation Flyback
- Eliminate Resonant Ring Interference
- Fast Detector of Supply Voltages
- Fewest External Components
- **Totally Lead-free & Fully RoHS Compliant (Notes 1 & 2)**
- **Halogen and Antimony Free. "Green" Device (Note 3)**

Notes: 1. No purposely added lead. Fully EU Directive 2002/95/EC (RoHS) & 2011/65/EU (RoHS 2) compliant.  
 2. See [http://www.diodes.com/quality/lead\\_free.html](http://www.diodes.com/quality/lead_free.html) for more information about Diodes Incorporated's definitions of Halogen- and Antimony-free, "Green" and Lead-free.  
 3. Halogen- and Antimony-free "Green" products are defined as those which contain <900ppm bromine, <900ppm chlorine (<1500ppm total Br + Cl) and <1000ppm antimony compounds.

**Pin Assignments**

(Top View)

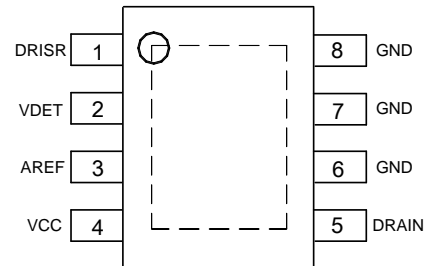

Note: The DRAIN pin of internal MOSFET is exposed PAD, which is at the bottom of IC (the dashed box). The secondary current should flow from GND(pin 6,7,8) to this exposed PAD.

SO-8EP

**Applications**

- Adapters/Chargers for Cell/Cordless Phones, ADSL Modems, MP3 and Other Portable Apparatus
- Standby and Auxiliary Power Supplies

**Typical Applications Circuit**

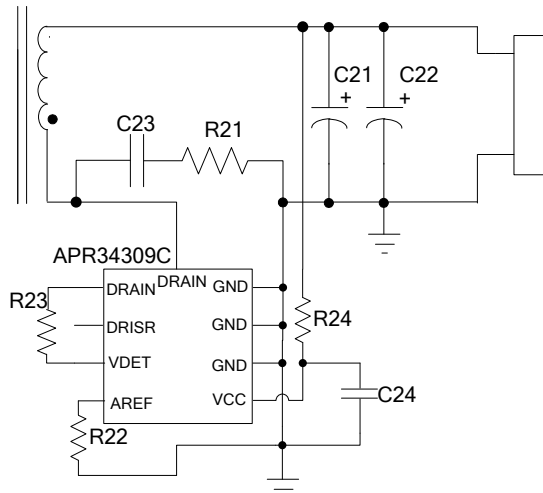

**Pin Descriptions**

Pin Number	Pin Name	Function
1	DRISR	Synchronous rectification MOSFET drive.
2	VDET	Synchronous rectification sense input and dynamic function output, connected to DRAIN through a resistor.
3	AREF	Program a voltage reference with a resistor from AREF to GND, to enable synchronous rectification MOSFET drive signal.
4	VCC	Power supply, connected with system output.
5	DRAIN	Drain pin of internal MOSFET. The Drain voltage signal can obtain from this pin.
6,7,8	GND	Source pin of internal MOSFET, connected to Ground.
Exposed PAD	DRAIN	Drain pin of internal MOSFET. The secondary current should flow from GND (pin 6.7.8) to this DRAIN pad.

NEW PRODUCT

**Functional Block Diagram**

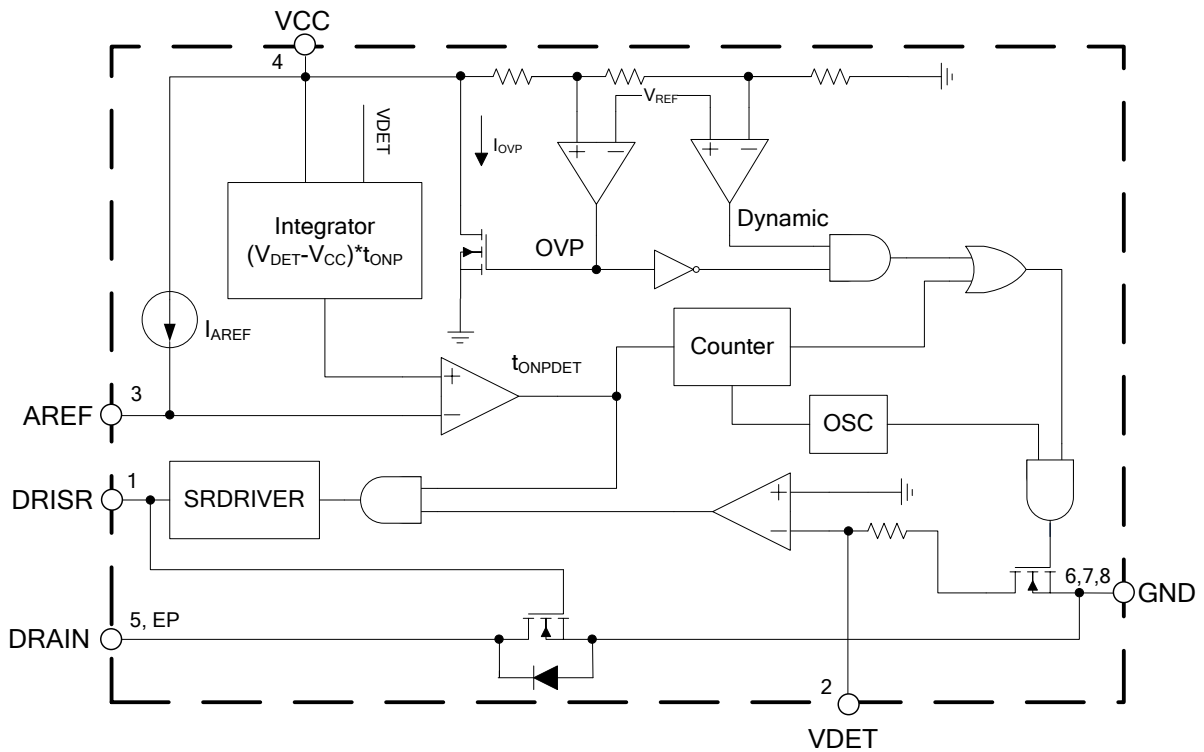

## Absolute Maximum Ratings (Note 4)

Symbol	Parameter	Value	Unit
$V_{CC}$	Supply Voltage	-0.3 to 7.5	V
$V_{DET}, V_{DRAIN}$	Voltage at VDET, DRAIN Pin	-2 to 50	V
$V_{AREF}, V_{DRISR}$	Voltage at AREF, DRISR Pin	-0.3 to 6	V
$I_D$	Continuous Drain Current	20	A
$I_{DM}$	Pulsed Drain Current	80	A
$P_D$	Power Dissipation at $T_A=+25^{\circ}C$	2.2	W
$\theta_{JA}$	Thermal Resistance (Junction to Ambient) (Note 5)	56	$^{\circ}C/W$
$\theta_{JC}$	Thermal Resistance (Junction to Case) (Note 5)	12	$^{\circ}C/W$
$T_J$	Operating Junction Temperature	+150	$^{\circ}C$
$T_{STG}$	Storage Temperature	-65 to +150	$^{\circ}C$
$T_{LEAD}$	Lead Temperature (Soldering, 10 sec)	+300	$^{\circ}C$
ESD	Charge Device Model	1000	V

- Notes: 4. Stresses greater than those listed under "Absolute Maximum Ratings" may cause permanent damage to the device. These are stress ratings only, and functional operation of the device at these or any other conditions beyond those indicated under "Recommended Operating Conditions" is not implied. Exposure to "Absolute Maximum Ratings" for extended periods may affect device reliability.  
5. FR-4 substrate PC board, 2oz copper, with 1 inch<sup>2</sup> pad layout.

## Recommended Operating Conditions

Symbol	Parameter	Min	Max	Unit
$V_{CC}$	Supply Voltage	3.3	6	V
$T_A$	Ambient Temperature	-40	+85	$^{\circ}C$

**Electrical Characteristics** (@T<sub>A</sub> = +25°C, V<sub>CC</sub>=5V, unless otherwise specified.)

Symbol	Parameter	Conditions	Min	Typ	Max	Unit
<b>Supply Voltage ( VCC Pin )</b>						
I <sub>STARTUP</sub>	Startup Current	V <sub>CC</sub> =V <sub>STARTUP</sub> -0.1V	–	100	150	μA
I <sub>OP</sub>	Operating Current	V <sub>DET</sub> pin floating V <sub>CC</sub> =V <sub>TRIGGER</sub> +20mV	40	100	150	μA
V <sub>STARTUP</sub>	Startup Voltage	–	2.6	3.1	3.4	V
–	UVLO	–	2.3	2.8	3.1	V
<b>Dynamic Output Section/Oscillator Section</b>						
V <sub>TRIGGER</sub>	Internal Trigger Voltage	–	5.1	5.15	5.2	V
–	Duty Cycle	–	4	15	18	%
t <sub>OSC</sub>	Oscillation Period	V <sub>CC</sub> =5V	18	30	37.5	μs
I <sub>TRIGGER</sub>	Internal Trigger Current	V <sub>CC</sub> =V <sub>TRIGGER</sub> , V <sub>CC</sub> /V <sub>DET</sub> pin is separately connected to a 20Ω resistor	30	60	80	mA
t <sub>DIS</sub>	Minimum Period	–	18	30	37.5	ms
V <sub>DIS</sub>	Discharge Voltage	–	5.13	5.3	5.38	V
I <sub>DIS</sub>	Discharge Current	V <sub>CC</sub> =V <sub>DIS</sub> +0.1V	1.5	3	4.5	mA
V <sub>DIS</sub> -V <sub>TRIGGER</sub>	Trigger Discharger Gap	–	30	110	–	mV
V <sub>OVP</sub>	Overshoot Voltage for Discharge	–	5.64	5.74	5.84	V
I <sub>OVP</sub>	Overshoot Current for Discharge	V <sub>CC</sub> =V <sub>OVP</sub> +0.1V, V <sub>CC</sub> pin is connected to a 20Ω resistor	40	–	100	mA
<b>Synchronous Voltage Detect</b>						
V <sub>THON</sub>	Gate Turn-on Threshold	–	0	–	1	V
V <sub>THOFF</sub>	Gate Turn-off Threshold	–	-13	-9	-5	mV
t <sub>DON</sub>	Turn-on Delay Time	From V <sub>THON</sub> to V <sub>DRISR</sub> =1V	–	70	130	ns
t <sub>DOFF</sub>	Turn-off Propagation Delay Time	From V <sub>THOFF</sub> to V <sub>DRISR</sub> =3V	–	100	150	ns
t <sub>RG</sub>	Gate Turn-on Rising Time	From 1V to 3V, C <sub>L</sub> =4.7nF	–	50	100	ns
t <sub>FG</sub>	Gate Turn-off Falling Time	From 3V to 1V, C <sub>L</sub> =4.7nF	–	50	100	ns
t <sub>LEB_S</sub>	Minimum On Time	(V <sub>DET</sub> -V <sub>CC</sub> )*t <sub>ONP</sub> = 25Vμs	0.9	1.8	2.7	μs
t <sub>LEB_L</sub>		(V <sub>DET</sub> -V <sub>CC</sub> )*t <sub>ONP</sub> = 50Vμs	–	–	6.5	
V <sub>DRISR_HIGH</sub>	Drive Output Voltage	V <sub>CC</sub> =5V	3.7	–	–	V
V <sub>S_MIN</sub>	SR Minimum Operating Voltage (Note 6)	–	–	–	4.5	V
t <sub>OVP_LAST</sub>	Added OVP Discharge Time	–	–	2.0	–	ms
Kqs	(Note 7)	(V <sub>DET</sub> -V <sub>CC</sub> )*t <sub>ONP</sub> = 25Vμs	0.325	–	0.625	mA*μs

Notes: 6. This item specifies the minimum SR operating voltage of V<sub>IN\_DC</sub>, V<sub>IN\_DC</sub> ≥ N<sub>PS</sub> \* V<sub>S\_MIN</sub>.

7. This item is used to specify the value of R<sub>AREF</sub>.

**Electrical Characteristics** (@T<sub>A</sub> = +25°C, unless otherwise specified. Cont.)

**MOSFET Static Characteristics**

Parameters	Symbol	Conditions	Min	Typ	Max	Unit
Drain to Source Breakdown Voltage	V <sub>DSS(BR)</sub>	V <sub>GS</sub> =0V, I <sub>D</sub> =0.25mA	62	–	100	V
Gate Threshold Voltage	V <sub>GS(TH)</sub>	V <sub>DS</sub> =V <sub>GS</sub> , I <sub>D</sub> =0.25mA	0.7	1.1	2	V
Zero Gate Voltage Drain Current	I <sub>DSS</sub>	V <sub>DS</sub> =50V, V <sub>GS</sub> =0V	–	–	80	nA
Gate to Source Leakage Current	I <sub>GSS</sub>	V <sub>GS</sub> =10V, V <sub>DS</sub> =0V	–	–	±7	μA
Drain to Source On-state Resistance	R <sub>DS(ON)</sub>	V <sub>GS</sub> =4.5V, I <sub>D</sub> =3A	–	9	–	mΩ

**MOSFET Dynamic Characteristics**

Parameters	Symbol	Conditions	Min	Typ	Max	Unit
Input Capacitance	C <sub>iss</sub>	V <sub>GS</sub> =0V, V <sub>DS</sub> =25V, f=1MHz	–	1316	–	pF
Output Capacitance	C <sub>oss</sub>		–	97	–	
Reverse Transfer Capacitance	C <sub>rss</sub>		–	85	–	
Gate to Source Charge	Q <sub>gs</sub>	V <sub>GS</sub> =0V to 10V, V <sub>DD</sub> =25V, I <sub>D</sub> =15A	–	3.2	–	nC
Gate to Drain Charge (Miller Charger)	Q <sub>gd</sub>		–	5.7	–	
Total Gate Charge	Q <sub>g</sub>	V <sub>GS</sub> =4.5V	–	15.2	–	
Gate Resistance	R <sub>g</sub>	–	–	0.85	–	Ω

**Performance Characteristics**

**Startup Voltage vs. Temperature**

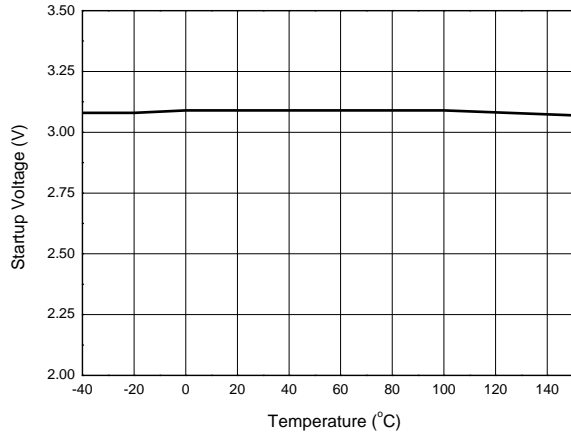

**UVLO vs. Temperature**

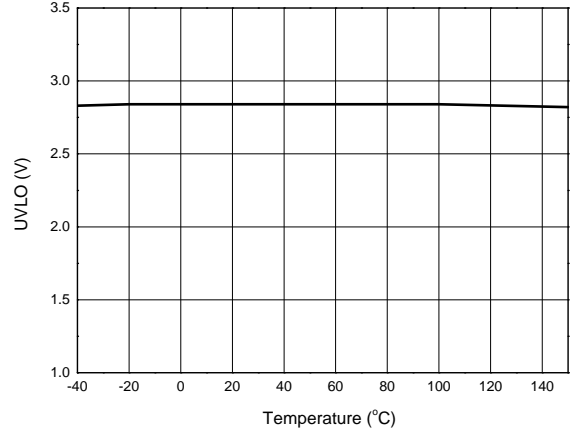

**Internal Trigger Voltage vs. Temperature**

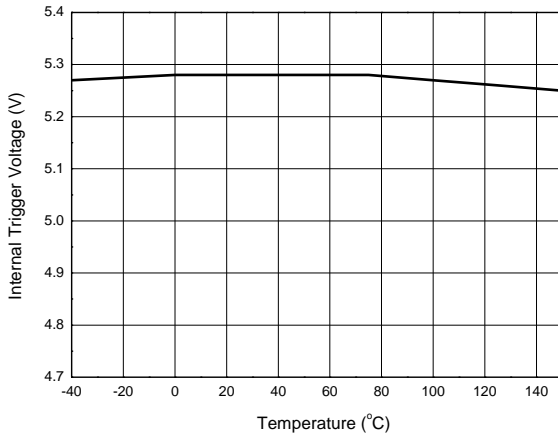

**Internal Trigger Current vs. Temperature**

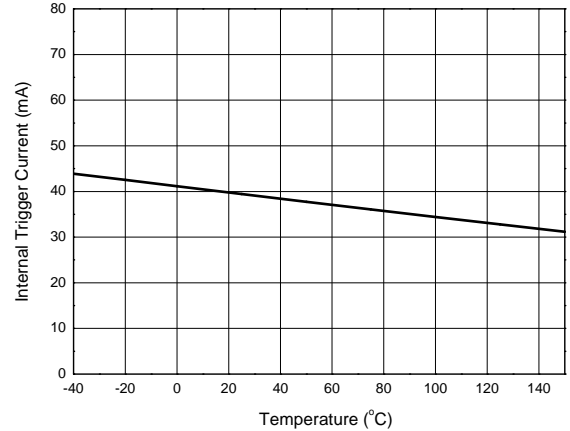

**Overshoot Voltage for Discharge vs. Temperature**

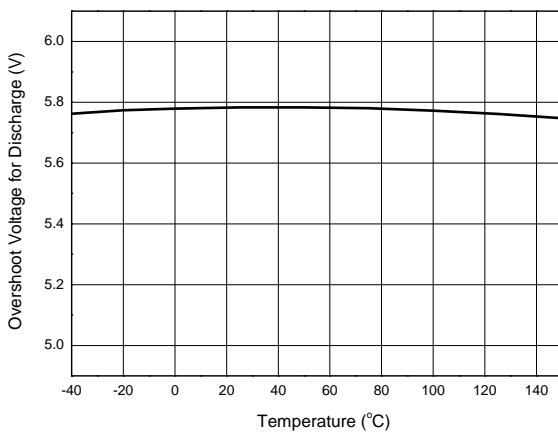

**Overshoot Current for Discharge vs. Temperature**

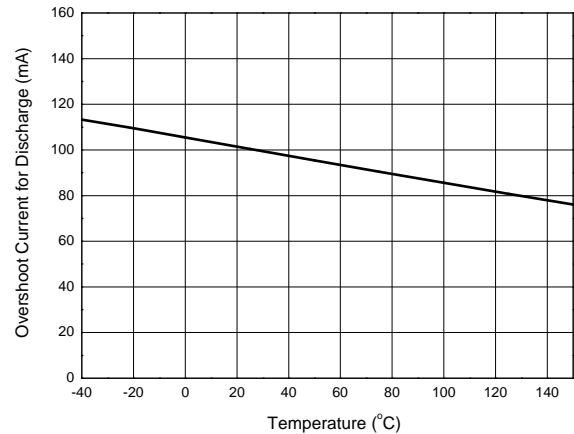

NEW PRODUCT

**Performance Characteristics (Cont.)**

NEW PRODUCT

**Gate Turn Off Threshold vs. Temperature**

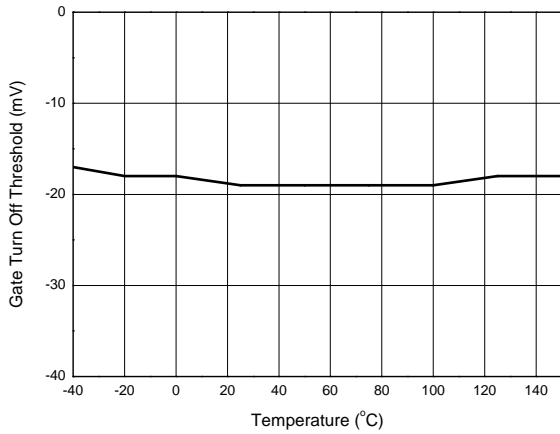

**Kqs (See Note 7) vs. Temperature**

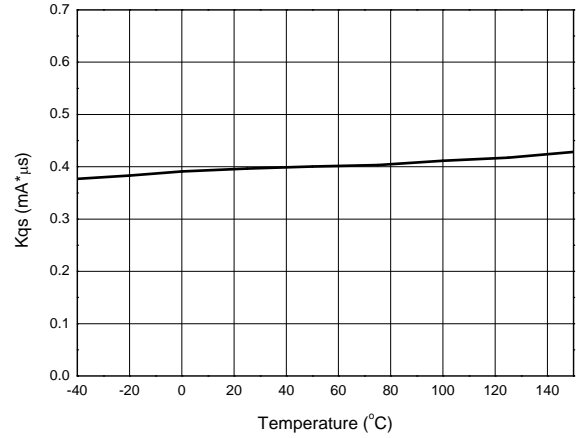

**Operating Current vs. Temperature**

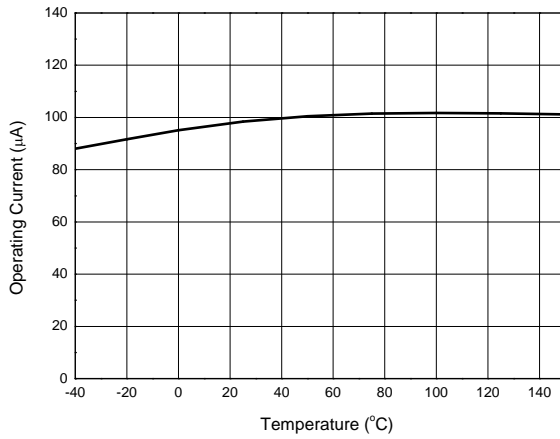

**Drain to Source On-state Resistance vs. Temperature**

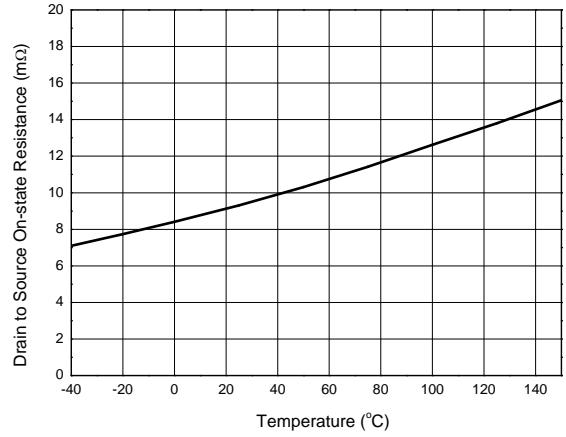

## Output Voltage Detect Function Description

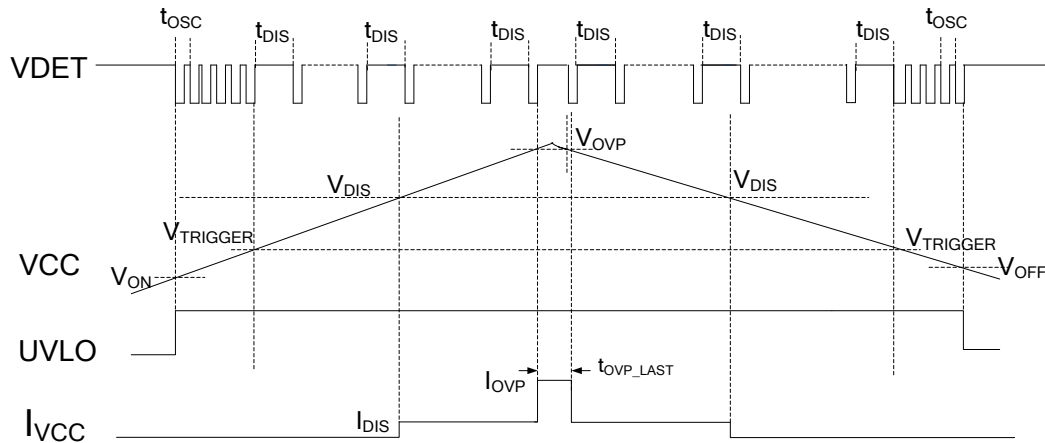

Figure 1. Typical Waveforms of APR34309C

When  $V_{CC}$  is beyond power-on voltage ( $V_{ON}$ ), the APR34309C starts up. The VDET pin asserts a periodical pulse and the oscillation period is  $t_{OSC}$ . When  $V_{CC}$  is beyond the trigger voltage ( $V_{TRIGGER}$ ), the periodical pulse at VDET pin is discontinued. When  $V_{CC}$  is beyond the discharge voltage ( $V_{DIS}$ ), the discharge circuit will be enabled, and a 3mA current ( $I_{DIS}$ ) will flow into VCC pin. When  $V_{CC}$  is higher than the overshoot voltage ( $V_{OVP}$ ), the APR34309C will enable a discharge circuit, the discharge current ( $I_{OVP}$ ) will last  $t_{OVP\_LAST}$  time. After the  $t_{OVP\_LAST}$  time, APR34309C will stop the discharge current and detect VCC voltage again. If  $V_{CC}$  is still higher than  $V_{OVP}$ , the  $t_{OVP\_LAST}$  time discharge current will be enabled again. Once the OVP discharge current is asserted, the periodical pulse at VDET pin will be disabled.

When the  $V_{CC}$  falls below the power-off voltage ( $V_{OFF}$ ), the APR34309C will shut down.

## Operation Description

### MOSFET Driver

The operation of the SR is described with timing diagram shown in Figure 2. APR34309C monitors the MOSFET drain-source voltage. When the drain voltage is lower than the turn-on threshold voltage  $V_{THON}$ , the IC outputs a positive drive voltage after a turn-on delay time ( $t_{DON}$ ). The MOSFET will turn on and the current will transfer from the body diode into the MOSFET's channel.

In the process of drain current decreasing linearly toward zero, the drain-source voltage rises synchronically. When it rises over the turn off threshold voltage  $V_{THOFF}$ , APR34309C pulls the drive signal down after a turn-off delay ( $t_{DOFF}$ ).

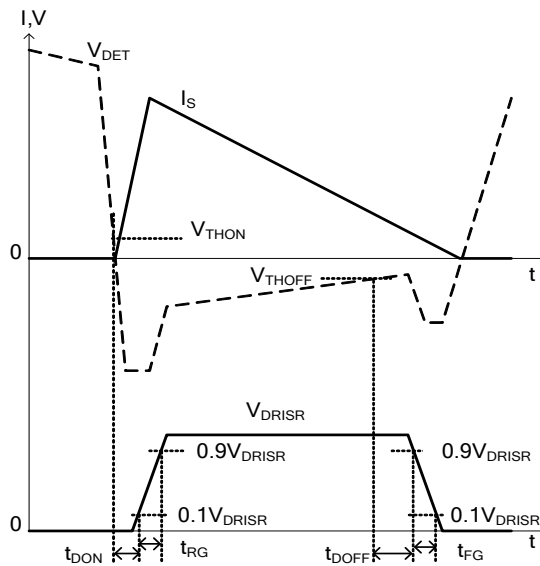

Figure 2. Typical Waveforms of APR34309C



**Operation Description (Cont.)**

**Minimum On Time**

When the controlled MOSFET gate is turned on, some ringing noise is generated. The minimum on-time timer blanks the  $V_{THOFF}$  comparator, keeping the controlled MOSFET on for at least the minimum on time. If  $V_{THOFF}$  falls below the threshold before minimum on time expires, the MOSFET will keep on until the end of the minimum on time.

The minimum on time is in direct proportion to the  $(V_{DET}-V_{CC}) * t_{ONP}$ . When  $(V_{DET}-V_{CC}) * t_{ONP} = 5V * 5\mu s$ , the minimum on time is about 1.8 $\mu s$ .

**The Value and Meaning of AREF Resistor**

As to DCM operation Flyback converter, after secondary rectifier stops conduction the primary MOSFET Drain-to-source ringing waveform is resulted from the resonant of primary inductance and equivalent switch device output capacitance. This ringing waveform probably leads to Synchronous Rectifier error conduction. To avoid this fault happening, APR34309C has a special function design by means of volt-second product detecting. From the sensed voltage of VDET pin to see, the volt-second product of voltage above  $V_{CC}$  at primary switch on time is much higher than the volt-second product of each cycle ringing voltage above  $V_{CC}$ . Therefore, before every time Synchronous Rectifier turning on, APR34309C judges if the detected volt-second product of VDET voltage above  $V_{CC}$  is higher than a threshold and then turn on synchronous Rectifier. The purpose of AREF resistor is to determine the volt-second product threshold. APR34309C has a parameter,  $K_{qs}$ , which converts  $R_{AREF}$  value to volt-second product,

$$Area2 = R_{AREF} * K_{qs}$$

In general, Area1 and Area3 value depend on system design and are always fixed after system design frozen. As to BCD PSR design, the Area1 value changes with primary peak current value and Area3 value generally keeps constant at all of conditions. So the AREF resistor design should consider the worst case, the minimum primary peak current condition. Since of system design parameter distribution, Area1 and Area3 have moderate tolerance. So Area2 should be designed between the middle of Area1 and Area3 to keep enough design margin.

$$Area3 < R_{AREF} * K_{qs} < Area1$$

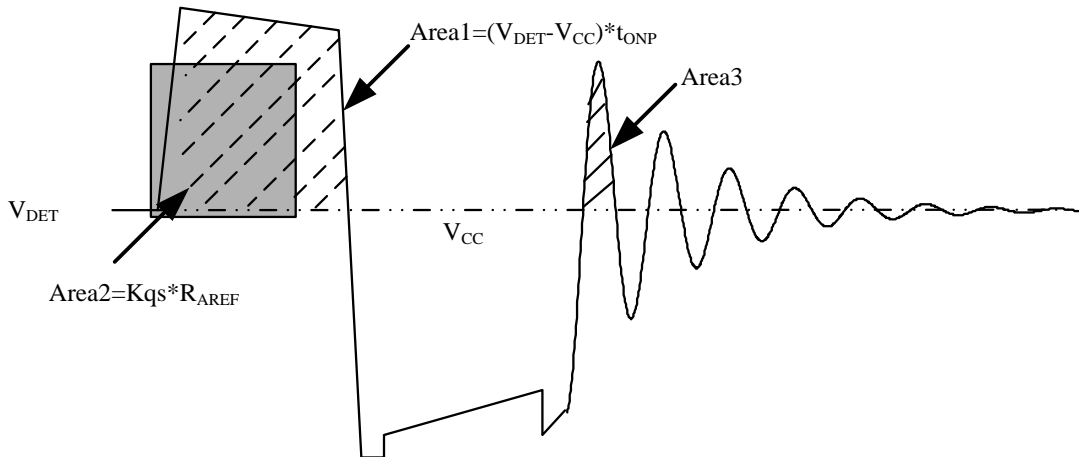

Figure 3. AREF Function

**SR Minimum Operating Voltage**

APR34309C sets a minimum SR operating voltage by comparing the difference between  $V_{DET}$  and output voltage ( $V_{CC}$ ). The value of  $V_{DET}-V_{CC}$  must be higher than its internal reference, then APR34309C will begin to integrate the area of  $(V_{DET}-V_{CC}) * t_{ONP}$ . If not, the area integrating will not begin and the SR driver will be disabled.

NEW PRODUCT

**Ordering Information**

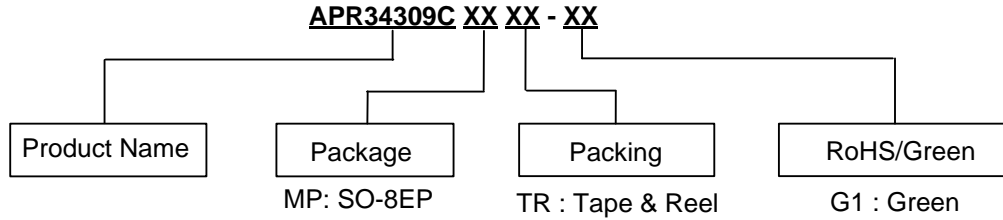

Package	Temperature Range	Part Number	Marking ID	Packing
SO-8EP	-40 to +85°C	APR34309CMPTR-G1	34309CMP-G1	4000/Tape & Reel

**Marking Information**

(Top View)

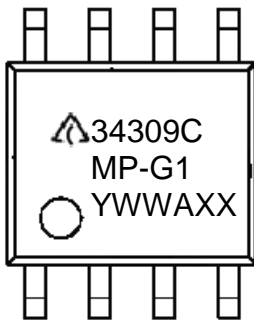

First and Second Lines: Logo and Marking ID  
 Third Line: Date Code  
 Y: Year  
 WW: Work Week of Molding  
 A: Assembly House Code  
 XX: 7<sup>th</sup> and 8<sup>th</sup> Digits of Batch No.

**Package Outline Dimensions** (All dimensions in mm(inch).)

(1) Package Type: SO-8EP

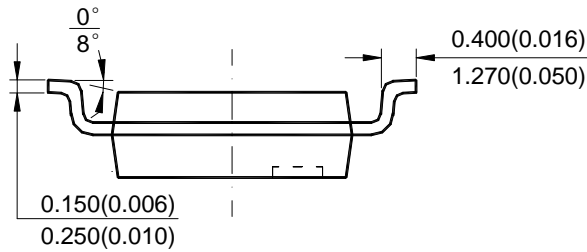
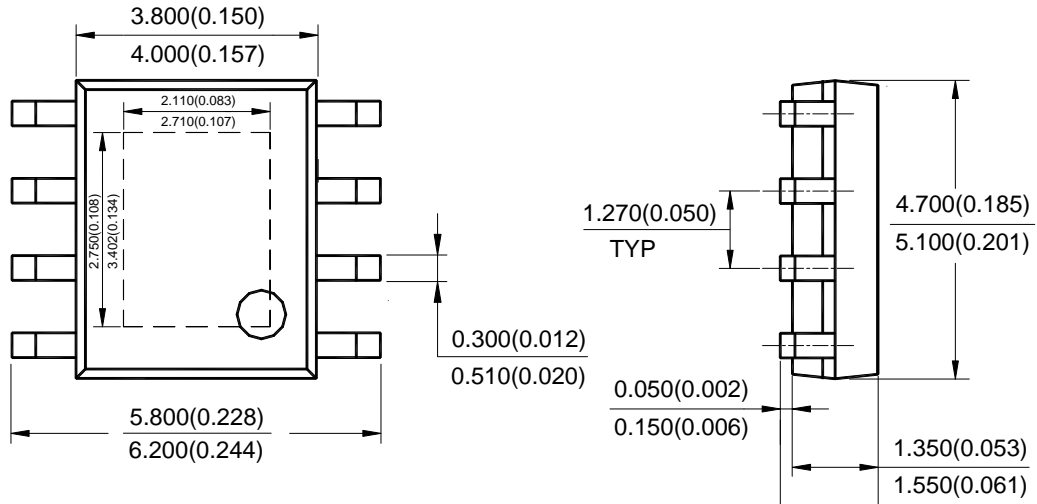

Note: Eject hole, oriented hole and mold mark is optional.

NEW PRODUCT

**Suggested Pad Layout**

(1) Package Type: SO-8EP

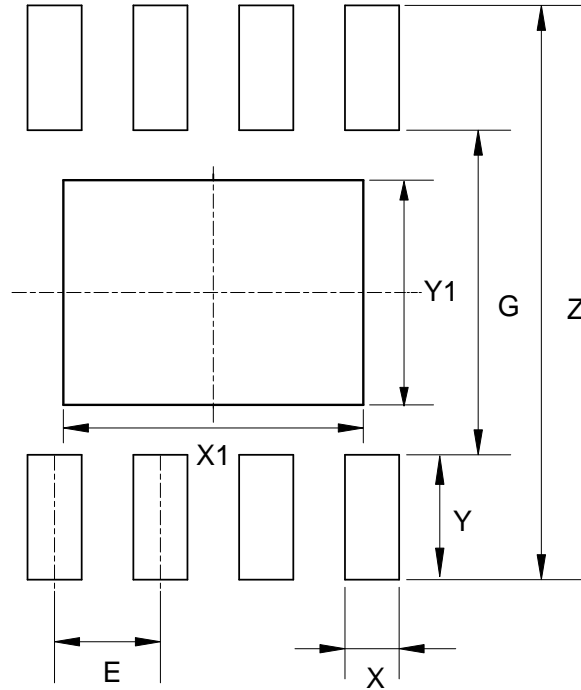

Dimensions	Z (mm)/(inch)	G (mm)/(inch)	X (mm)/(inch)	Y (mm)/(inch)	X1 (mm)/(inch)	Y1 (mm)/(inch)	E (mm)/(inch)
Value	6.900/0.272	3.900/0.154	0.650/0.026	1.500/0.059	3.600/0.142	2.700/0.106	1.270/0.050

NEW PRODUCT

#### IMPORTANT NOTICE

DIODES INCORPORATED MAKES NO WARRANTY OF ANY KIND, EXPRESS OR IMPLIED, WITH REGARDS TO THIS DOCUMENT, INCLUDING, BUT NOT LIMITED TO, THE IMPLIED WARRANTIES OF MERCHANTABILITY AND FITNESS FOR A PARTICULAR PURPOSE (AND THEIR EQUIVALENTS UNDER THE LAWS OF ANY JURISDICTION).

Diodes Incorporated and its subsidiaries reserve the right to make modifications, enhancements, improvements, corrections or other changes without further notice to this document and any product described herein. Diodes Incorporated does not assume any liability arising out of the application or use of this document or any product described herein; neither does Diodes Incorporated convey any license under its patent or trademark rights, nor the rights of others. Any Customer or user of this document or products described herein in such applications shall assume all risks of such use and will agree to hold Diodes Incorporated and all the companies whose products are represented on Diodes Incorporated website, harmless against all damages.

Diodes Incorporated does not warrant or accept any liability whatsoever in respect of any products purchased through unauthorized sales channel. Should Customers purchase or use Diodes Incorporated products for any unintended or unauthorized application, Customers shall indemnify and hold Diodes Incorporated and its representatives harmless against all claims, damages, expenses, and attorney fees arising out of, directly or indirectly, any claim of personal injury or death associated with such unintended or unauthorized application.

Products described herein may be covered by one or more United States, international or foreign patents pending. Product names and markings noted herein may also be covered by one or more United States, international or foreign trademarks.

This document is written in English but may be translated into multiple languages for reference. Only the English version of this document is the final and determinative format released by Diodes Incorporated.

#### LIFE SUPPORT

Diodes Incorporated products are specifically not authorized for use as critical components in life support devices or systems without the express written approval of the Chief Executive Officer of Diodes Incorporated. As used herein:

A. Life support devices or systems are devices or systems which:

1. are intended to implant into the body, or
2. support or sustain life and whose failure to perform when properly used in accordance with instructions for use provided in the labeling can be reasonably expected to result in significant injury to the user.

B. A critical component is any component in a life support device or system whose failure to perform can be reasonably expected to cause the failure of the life support device or to affect its safety or effectiveness.

Customers represent that they have all necessary expertise in the safety and regulatory ramifications of their life support devices or systems, and acknowledge and agree that they are solely responsible for all legal, regulatory and safety-related requirements concerning their products and any use of Diodes Incorporated products in such safety-critical, life support devices or systems, notwithstanding any devices- or systems-related information or support that may be provided by Diodes Incorporated. Further, Customers must fully indemnify Diodes Incorporated and its representatives against any damages arising out of the use of Diodes Incorporated products in such safety-critical, life support devices or systems.

Copyright © 2014, Diodes Incorporated

[www.diodes.com](http://www.diodes.com)