

## ■ FEATURES

- 110m $\Omega$  (5V Input) High-Side MOSFET Switch.
- 1A Continuous Load Current per Channel.
- 110 $\mu$ A Typical On-State Supply Current.
- 1 $\mu$ A Typical Off-State Supply Current.
- Current-Limit / Short Circuit Protection.
- Fault Flag with 3ms filter eliminates false assertions. (1518D)
- Thermal Shutdown Protection under Overcurrent Condition.
- Undervoltage Lockout Ensures that Switch is off at Start Up.
- Open-Drain Fault Flag.
- Slow Turn ON and Fast Turn OFF.
- Enable Active-High or Active-Low.

## ■ APPLICATIONS

- USB Power Management.
- Hot Plug-In Power Supplies.
- Battery-Charger Circuit.

## ■ DESCRIPTION

The AIC1518 is a dual high-side power switch for self-powered and bus-powered Universal Serial Bus (USB) applications. Both high-side switches are MOSFET with 110m $\Omega$   $R_{DS(ON)}$ , which meets USB voltage drop requirements for maximum transmission wire length.

Multi-purpose open-drain fault flag output indicates over-current limiting, thermal shutdown, or undervoltage lockout for each channel. Output current is typically limited to 1.25A, and the thermal shutdown functions of the power switches independently control their channel under overcurrent condition.

Guaranteed minimum output rise time limits inrush current during hot plug-in as well as minimizing EMI and prevents the voltage at upstream port from dropping excessively.

## ■ TYPICAL APPLICATION CIRCUIT

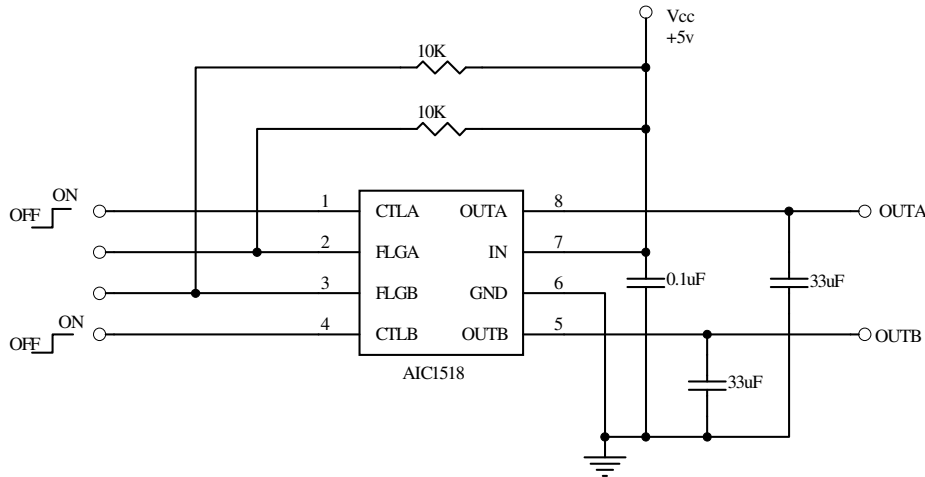

## ■ ORDERING INFORMATION

AIC1518X-XXXXX

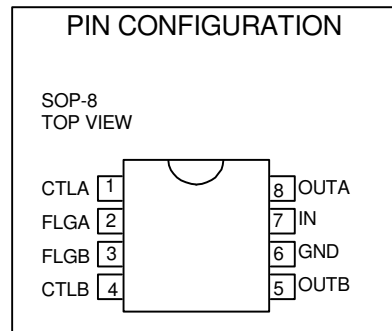
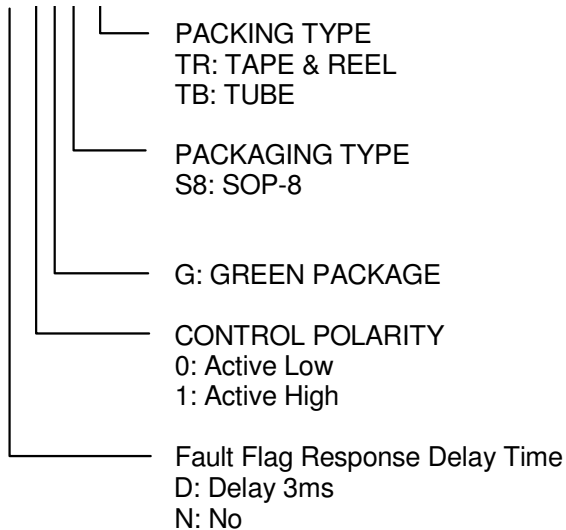

Example: AIC1518D-0GS8TR

→ Delay 3ms, Active Low Version, in SOP-8 Green  
Package & Taping & Reel Packing Type

AIC1518N-1GS8TR

→ No Delay, Active High Version, in SOP-8 Green  
Package & Taping & Reel Packing Type

**■ ABSOLUTE MAXIMUM RATINGS**

|   |               |
|---|---------------|
| Supply Voltage ( $V_{IN}$ ).....                                      | 7.0V          |
| Fault Flag Voltage ( $V_{FLG}$ ) .....                                | 7.0V          |
| Fault Flag Current ( $I_{FLG}$ ).....                                 | 50mA          |
| Control Input ( $V_{CTL}$ ).....                                      | -0.3V ~7V     |
| Operating Temperature Range.....                                      | -40°C~85°C    |
| Junction Temperature.....   | 150°C         |
| Storage Temperature Range.....  | -65°C ~ 150°C |
| Lead Temperature (Soldering, 10sec) .....                             | 260°C         |
| Thermal Resistance, $\theta_{JA}$ (Junction to Ambient)    SOP-8..... | 160°C/W       |
| (Assume no Ambient Airflow, no Heatsink)                              |               |
| Thermal Resistance, $\theta_{JC}$ (Junction to Case)    SOP-8.....    | 40°C /W       |

**Absolute Maximum Ratings are those values beyond which the life of a device may be impaired.**

**■ ELECTRICAL CHARACTERISTICS**

( $V_{IN}=5V$ ,  $T_A=25^{\circ}C$ , unless otherwise specified.) (Note 1)

| PARAMETERS                              | CONDITIONS   | MIN. | TYP.         | MAX.     | UNIT        |
|---|--|------|--------------|----------|-------------|
| Supply Voltage                          |  | 3.1  |              | 6.0      | V           |
| Supply Current                          | $V_{CTL} = \text{Logic "0"}$ , OUT=Open<br>$V_{CTL} = \text{Logic "1"}$ , OUT=Open |      | 0.75<br>110  | 5<br>160 | $\mu A$     |
| Control Input Voltage                   | $V_{CTL} = \text{Logic "0"}$<br>$V_{CTL} = \text{Logic "1"}$                       | 2.4  |              | 0.8      | V           |
| Control Input Current                   | $V_{CTL} = \text{Logic "0"}$<br>$V_{CTL} = \text{Logic "1"}$                       |      | 0.01<br>0.01 | 1<br>1   | $\mu A$     |
| Control Input Capacitance               |  |      | 1            |          | pF          |
| Output MOSFET Resistance                |  |      | 110          | 150      | m $\Omega$  |
| Output Turn-On Rise Delay               | $R_L = 10\Omega$ each Output   |      | 600          | 1000     | $\mu S$     |
| Output Turn-On Rise Time                | $R_L = 10\Omega$ each Output   |      | 1800         | 3000     | $\mu S$     |
| Output Turn-Off Delay                   | $R_L = 10\Omega$ each Output   |      | 0.8          | 20       | $\mu S$     |
| Output Turn-Off Fall Time               | $R_L = 10\Omega$ each Output   |      | 0.7          | 20       | $\mu S$     |
| Output Leakage Current                  |  |      |              | 10       | $\mu A$     |
| Current Limit Threshold                 |  | 1.05 | 1.25         | 1.45     | A           |
| Over Current Flag Response Delay(Note2) | Apply $V_{OUT} = 0V$ until FLG low   | 1.5  | 3            | 7        | ms          |
| Over Temperature Shutdown Threshold     | $T_J$ Increasing<br>$T_J$ Decreasing   |      | 135<br>125   |          | $^{\circ}C$ |
| Error Flag Output Resistance            | $V_{IN} = 5V$ , $I_L = 10\text{ mA}$<br>$V_{IN} = 3.3V$ , $I_L = 10\text{ mA}$     |      | 15<br>15     | 30<br>40 | $\Omega$    |
| Error Flag Off Current                  | $V_{FLG} = 5V$   |      | 0.01         | 1        | $\mu A$     |
| UVLO Threshold                          | $V_{IN}$ Increasing<br>$V_{IN}$ Decreasing   | 2.45 | 2.85<br>2.65 | 3.05     | V           |

Note 1: Specifications are production tested at  $T_A=25^{\circ}C$ . Specifications over the  $-40^{\circ}C$  to  $85^{\circ}C$  operating temperature range are assured by design, characterization and correlation with Statistical Quality Controls (SQC).

Note 2: This parameter belongs to AIC1518D-XXXXX.

**TYPICAL PERFORMANCE CHARACTERISTICS**

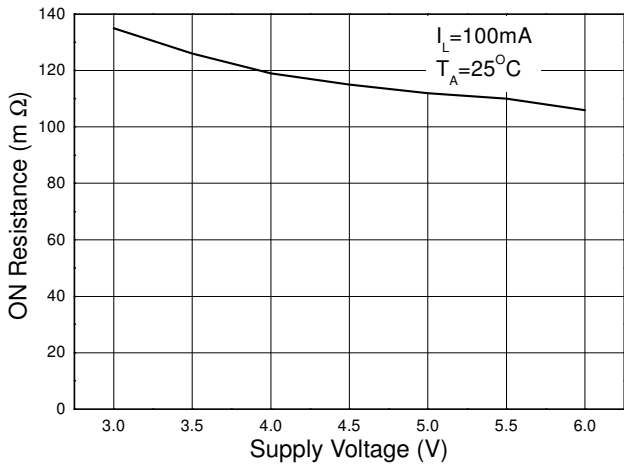

Fig. 1 ON Resistance vs. Supply Voltage

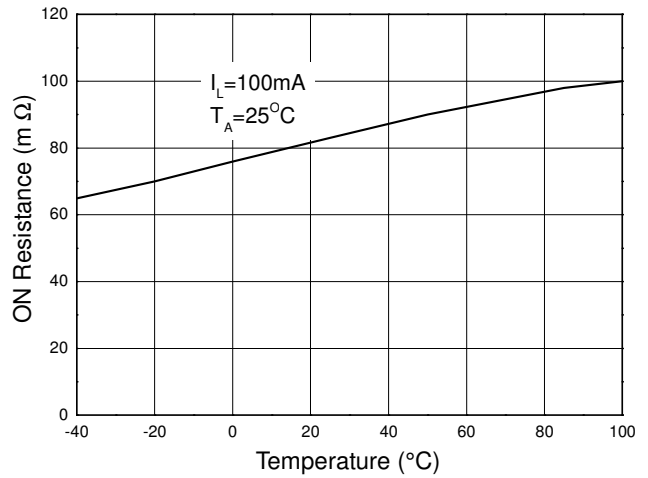

Fig. 2 ON Resistance vs. Temperature

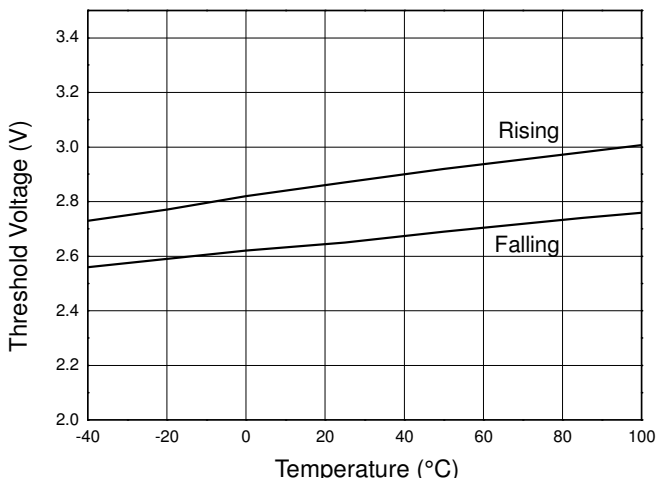

Fig. 3 UVLO Threshold Voltage vs. Temperature

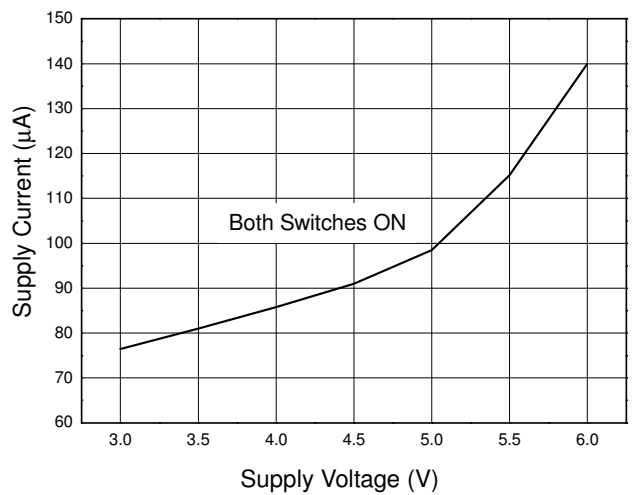

Fig. 4 ON-State Supply Current vs. Supply Voltage

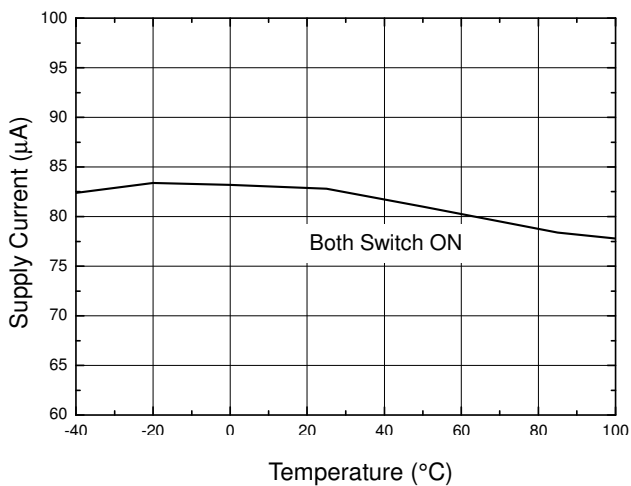

Fig. 5 ON State Current vs. Temperature

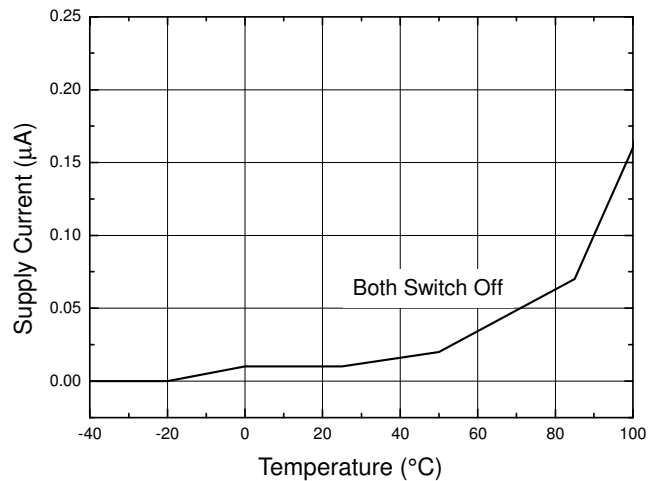

Fig. 6 OFF-State Current vs. Temperature

**TYPICAL PERFORMANCE CHARACTERISTICS (Continued)**

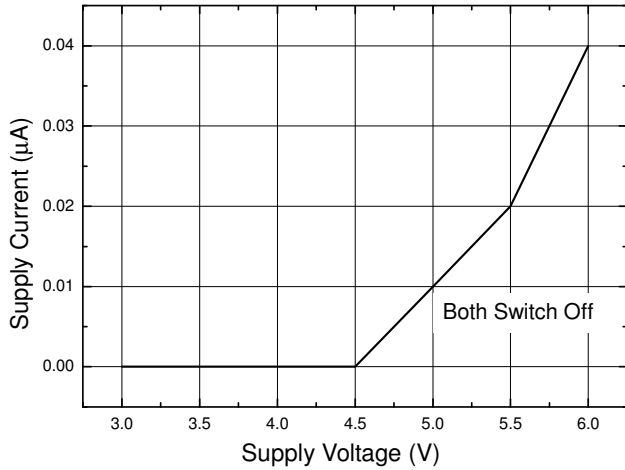

Fig. 7 OFF-State Current vs. Supply Voltage

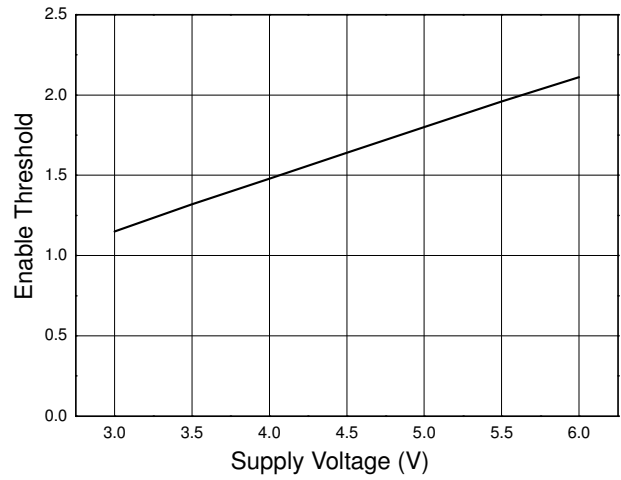

Fig. 8 Enable Threshold vs. Supply Voltage

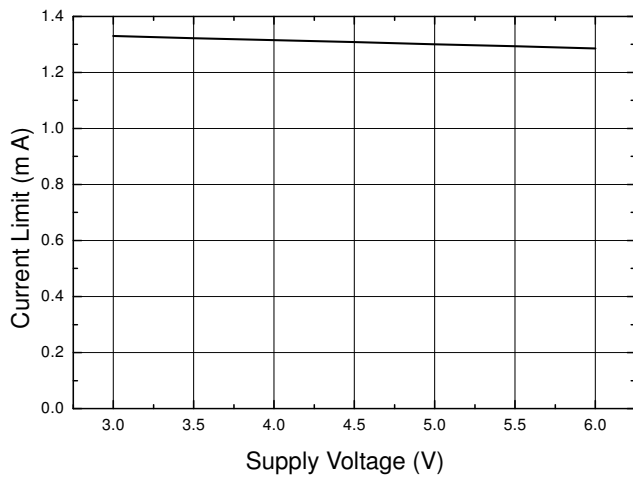

Fig. 9 Current Limit vs. Supply Voltage

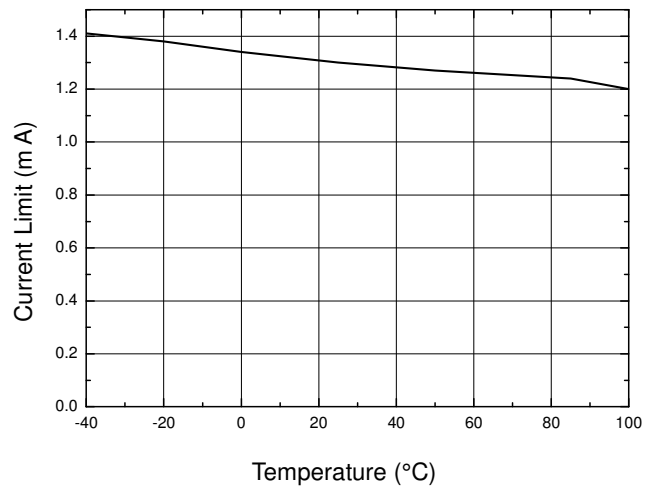

Fig. 10 Current Limit vs. Temperature

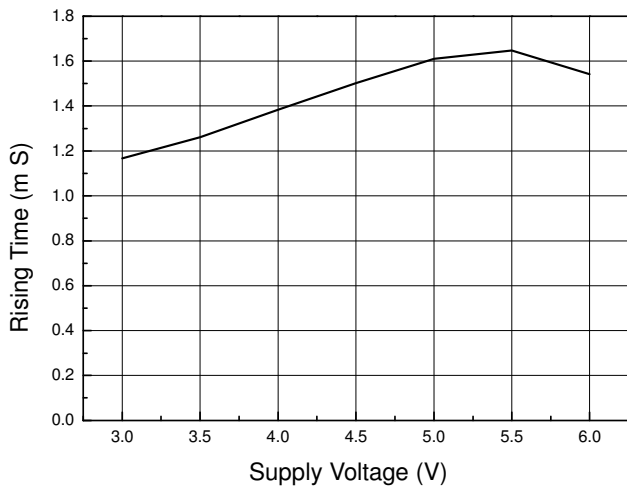

Fig. 11 Rising Time vs. Supply Voltage

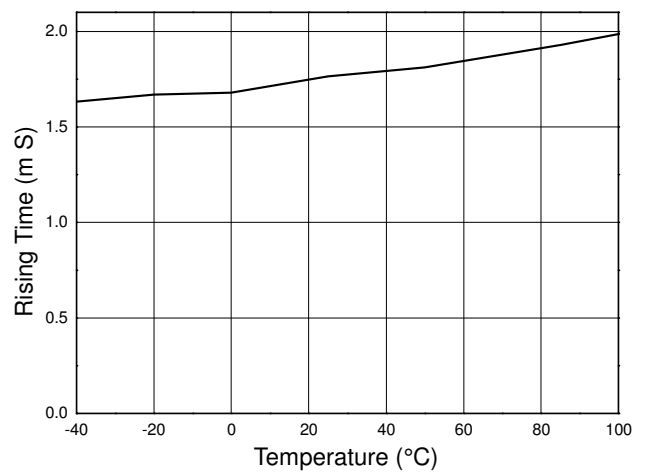

Fig. 12 Rising Time vs. Temperature

**TYPICAL PERFORMANCE CHARACTERISTICS (Continued)**

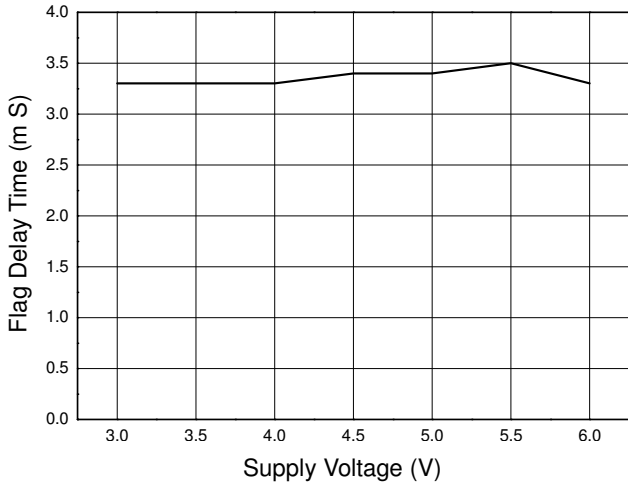

Fig. 13 Flag Delay Time vs. Supply Voltage

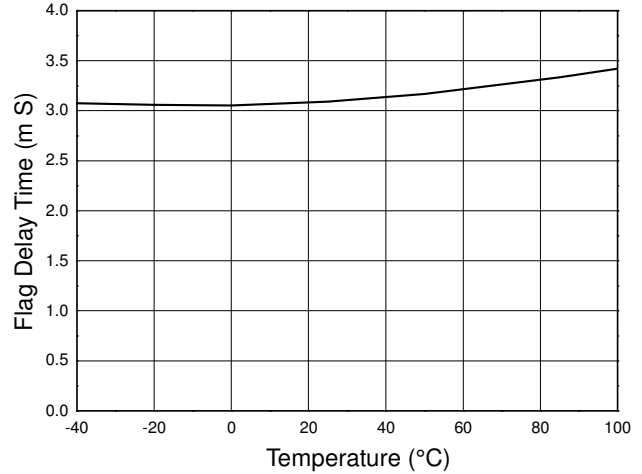

Fig. 14 Flag Delay Time vs. Temperature

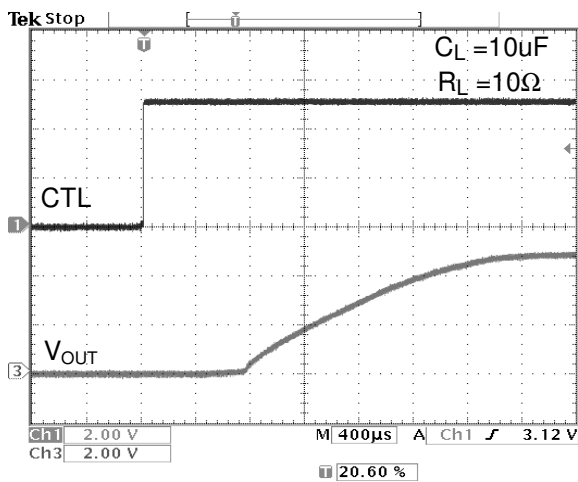

Fig. 15 Turn ON Time

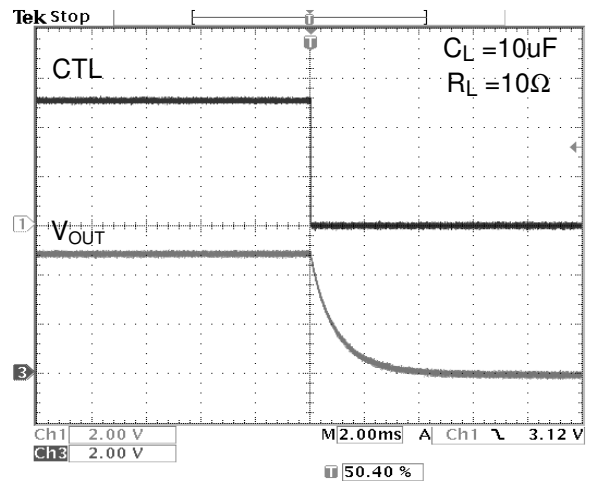

Fig. 16 Turn OFF Time

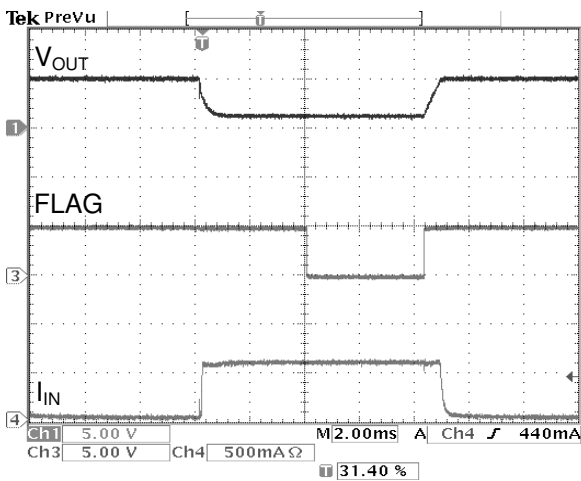

Fig. 17 Current Limit Event

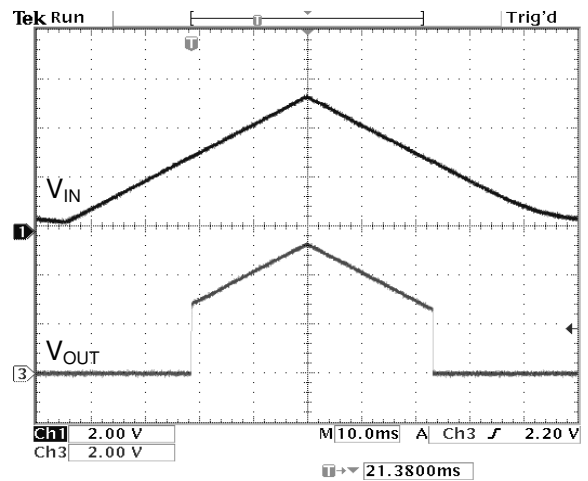
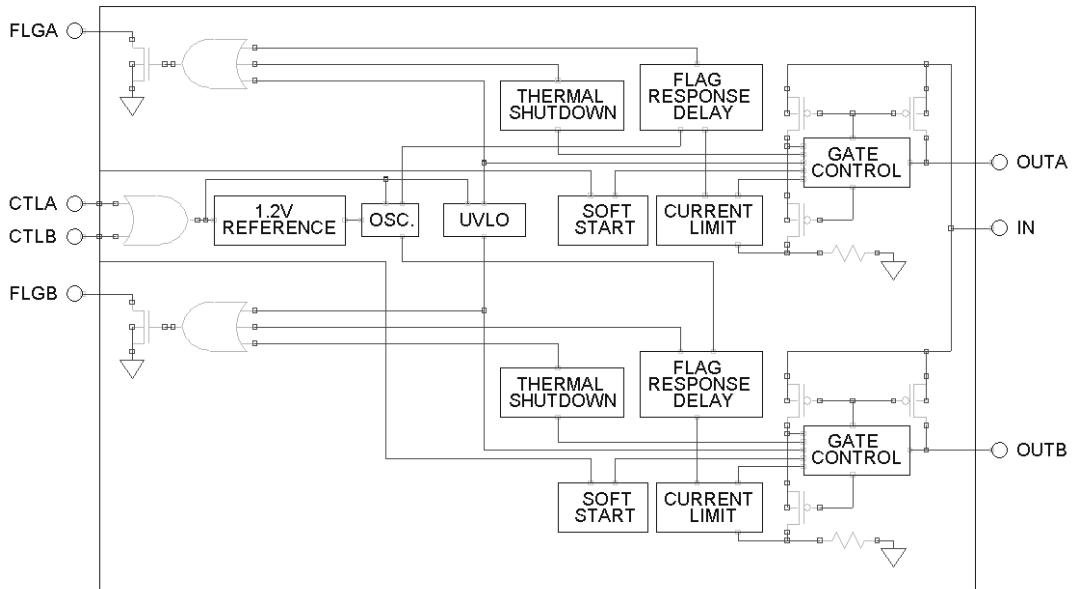

Fig. 18 UVLO Protection

## ■ BLOCK DIAGRAM



## ■ PIN DESCRIPTIONS

**PIN 1: CTLA** - Controls the turn-on/turn-off of channel A MOSFET with TTL as a control input. Active high for AIC1518-1 and active low for AIC1518-0.

**PIN 2: FLGA** - An active-low and open-drained fault flag output for channel A. FLGA is an indicator for current limit when CTLA is active. In normal mode operation (CTLA or/and CLTB is active), it also can indicate thermal shutdown or undervoltage.

**PIN 3: FLGB** - An active-low and open-drained fault flag output for channel B. FLGB is an indicator for current limit when CTLB is active. In normal mode operation (CTLB or/and CLTA is active), it also can indicate thermal shutdown or undervoltage.

**PIN 4: CTLB** - Controls the turn-on/turn-off of channel B MOSFET with TTL as a control input. Active High for AIC1518-1 and active low for AIC1518-0.

**PIN 5: OUTB** - Channel B MOSFET switch output.

**PIN 6: GND** - Chip power ground.

**PIN 7: IN** - Power supply input.

**PIN 8: OUTA** - Channel A MOSFET switch output.



## ■ APPLICATION INFORMATION

### ● Error Flag

An error Flag is an open-drained output of an N-channel MOSFET. FLG output is pulled low to signal the following fault conditions: input undervoltage, output current limit, and thermal shutdown. The Fault Flag response delay time is 3ms.

### ● Current Limit

The current limit threshold is preset internally. It protects the output MOSFET switches from damage resulting from undesirable short circuit conditions or excess inrush current, which is often encountered during hot plug-in. The low limit of the current limit threshold of the AIC1518 allows a minimum current of 1A through the MOSFET switches. The error flag signals when any current limit conditions occur.

### ● Thermal Shutdown

When temperature of AIC1518 exceeds 135°C for any reasons, the thermal shutdown function turns both MOSFET switches off and signals the error flag. A hysteresis of 10°C prevents the MOSFETs from turning back on until the chip temperature drops below 125°C. However, if thermal shutdown is triggered by chip temperature rise resulting from overcurrent fault condition of either one of the MOSFET switches, the thermal shutdown function will only turn off the switch that is in overcurrent condition and the other switch can still remain its normal operation. In other words, the thermal shutdown function of the two switches is independent of each other in the case of overcurrent fault.

### ● Supply Filtering

A 0.1μF to 1μF bypass capacitor from IN to GND, located near the device, is strongly recommended to control supply transients. Without a bypass capacitor, an output short may cause sufficient ringing on the input (from supply lead inductance) to damage internal control circuitry.

### ● Transient Requirements

USB supports dynamic attachment (hot plug-in) of peripherals. A current surge is caused by the input capacitance of downstream device. Ferrite beads are recommended in series with all power and ground connector pins. Ferrite beads reduce EMI and limit the inrush current during hot-attachment by filtering high-frequency signals.

### ● Short Circuit Transient

Bulk capacitance provides the short-term transient current needed during a hot-attachment event. A 33μF/16V tantalum or a 100μF/10V electrolytic capacitor mounted close to downstream connector each port should provide transient drop protection.

### ● Printed Circuit Layout

The power circuitry of USB printed circuit boards requires a customized layout to maximize thermal dissipation and to minimize voltage drop and EMI.

■ APPLICATION CIRCUIT

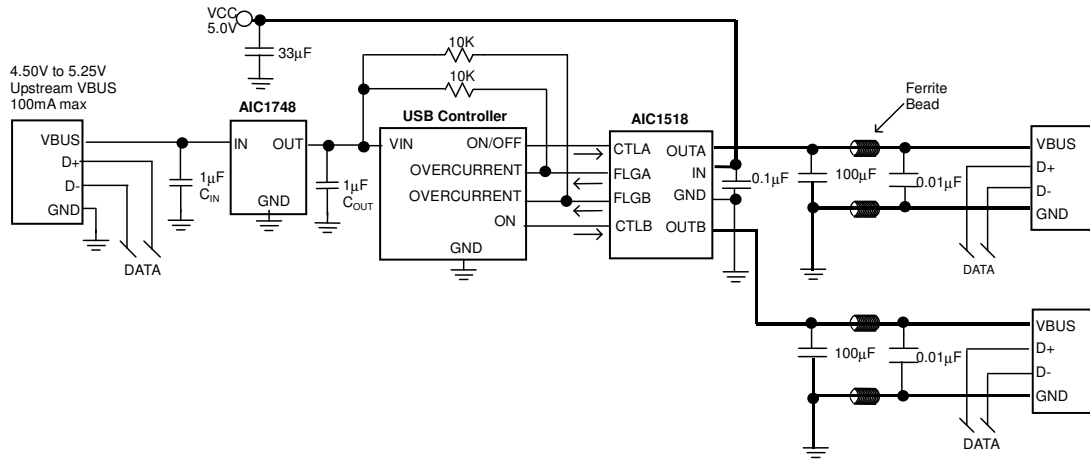
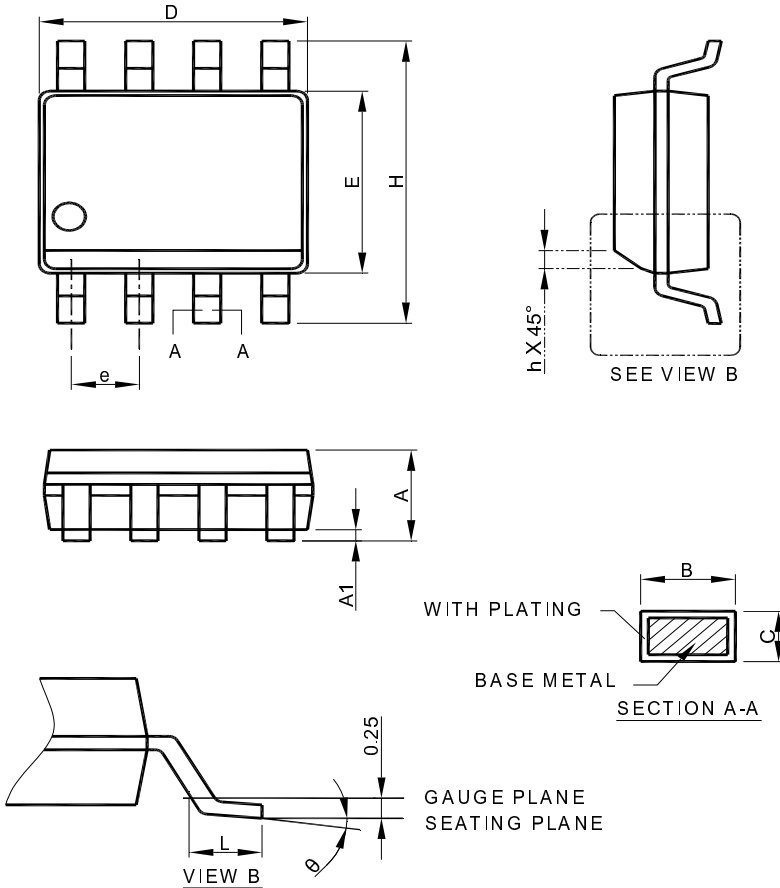

Fig. 19 Two-Port Self-Powered Hub

**PHYSICAL DIMENSIONS (unit: mm)**
**SOP-8**

| SYMBOL | SOP-8       |      |
|--------|-------------|------|
|        | MILLIMETERS |      |
|        | MN          | MAX  |
| A      | 1.35        | 1.75 |
| A1     | 0.10        | 0.25 |
| B      | 0.33        | 0.51 |
| C      | 0.19        | 0.25 |
| D      | 4.80        | 5.00 |
| E      | 3.80        | 4.00 |
| e      | 1.27 BSC    |      |
| H      | 5.80        | 6.20 |
| h      | 0.25        | 0.50 |
| L      | 0.40        | 1.27 |
| θ      | 0°          | 8°   |

- Note: 1. Refer to JEDEC MS-012AA.  
 2. Dimension "D" does not include mold flash, protrusions or gate burrs. Mold flash, protrusion or gate burrs shall not exceed 6 mil per side.  
 3. Dimension "E" does not include inter-lead flash or protrusions.  
 4. Controlling dimension is millimeter, converted inch dimensions are not necessarily exact.

**Note:**

Information provided by AIC is believed to be accurate and reliable. However, we cannot assume responsibility for use of any circuitry other than circuitry entirely embodied in an AIC product; nor for any infringement of patents or other rights of third parties that may result from its use. We reserve the right to change the circuitry and specifications without notice.

Life Support Policy: AIC does not authorize any AIC product for use in life support devices and/or systems. Life support devices or systems are devices or systems which, (i) are intended for surgical implant into the body or (ii) support or sustain life, and whose failure to perform, when properly used in accordance with instructions for use provided in the labeling, can be reasonably expected to result in a significant injury to the user.