

## 1.8V Nanopower Comparator with Internal 1.245V Reference

### FEATURES

- ◆ Second-source for MAX917
- ◆ Guaranteed to Operate Down to +1.8V
- ◆ Ultra-Low Supply Current: 750nA
- ◆ Internal 1.245V  $\pm 1.5\%$  Reference
- ◆ Input Voltage Range Extends 200mV Outside-the-Rails
- ◆ No Phase Reversal for Overdriven Inputs
- ◆ Push-pull Output
- ◆ Crowbar-Current-Free Switching
- ◆ Internal Hysteresis for Clean Switching
- ◆ 5-pin SOT23 and 8-pin SOIC Packaging

### APPLICATIONS

2-Cell Battery Monitoring/Management  
 Medical Instruments  
 Threshold Detectors/Discriminators  
 Sensing at Ground or Supply Line  
 Ultra-Low-Power Systems  
 Mobile Communications  
 Telemetry and Remote Systems

### DESCRIPTION

The TSM917 nanopower analog comparator is electrically and form-factor identical to the MAX917 analog comparator. Ideally suited for all 2-cell battery-management/monitoring applications, this 5-pin SOT23 analog comparator guarantees +1.8V operation, draws very little supply current, and has a robust input stage that can tolerate input voltages beyond its power supply. The TSM917 draws 750nA of supply current and includes an on-board 1.245V  $\pm 1.5\%$  reference.

The TSM917's push-push output drivers were designed to drive 8mA loads from one supply rail to the other supply rail. The TSM917 is also available in an 8-pin SOIC package.

### TYPICAL APPLICATION CIRCUIT

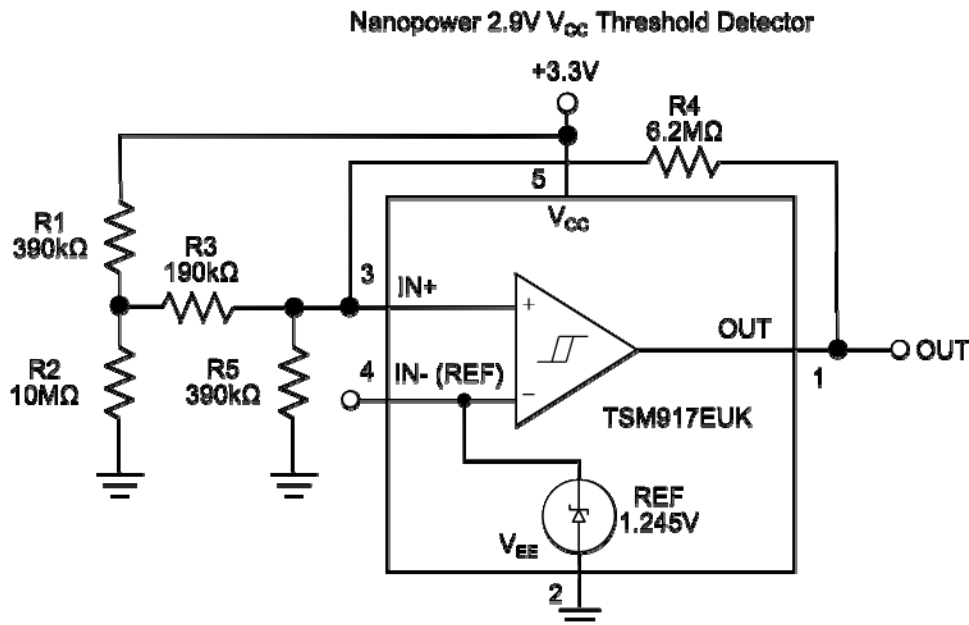

The Touchstone Semiconductor logo is a registered trademark of Touchstone Semiconductor, Incorporated.

## ABSOLUTE MAXIMUM RATINGS

Supply Voltage ( $V_{CC}$  to  $V_{EE}$ ) ..... +6V  
 Voltage Inputs ( $IN+$ ,  $IN-$ , REF) .... ( $V_{EE} - 0.3V$ ) to ( $V_{CC} + 0.3V$ )  
 Output Voltage  
 TSM917 ..... ( $V_{EE} - 0.3V$ ) to ( $V_{CC} + 0.3V$ )  
 Current Into Input Pins .....  $\pm 20mA$   
 Output Current .....  $\pm 50mA$   
 Output Short-Circuit Duration ..... 10s

Continuous Power Dissipation ( $T_A = +70^\circ C$ )  
 5-Pin SC70 (Derate 2.5mW/ $^\circ C$  above  $+70^\circ C$ ) ..... 200mW  
 8-Pin SOIC (Derate 5.88mW/ $^\circ C$  above  $+70^\circ C$ ) ..... 471mW  
 Operating Temperature Range .....  $-40^\circ C$  to  $+85^\circ C$   
 Junction Temperature .....  $+150^\circ C$   
 Storage Temperature Range .....  $-65^\circ C$  to  $+150^\circ C$   
 Lead Temperature (soldering, 10s) .....  $+300^\circ$

Electrical and thermal stresses beyond those listed under "Absolute Maximum Ratings" may cause permanent damage to the device. These are stress ratings only and functional operation of the device at these or any other condition beyond those indicated in the operational sections of the specifications is not implied. Exposure to any absolute maximum rating conditions for extended periods may affect device reliability and lifetime.

## PACKAGE/ORDERING INFORMATION

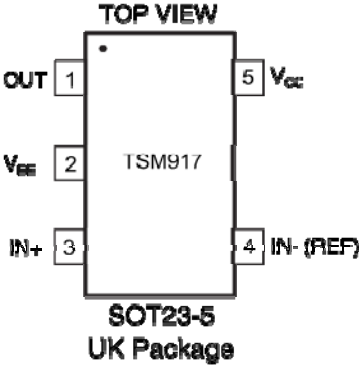
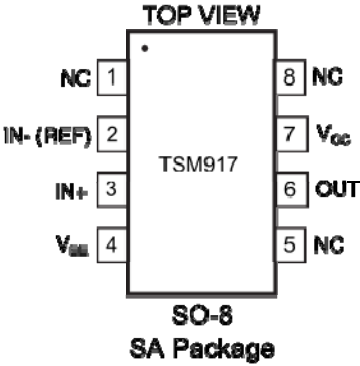
 <p style="text-align: center;"><b>SOT23-5 UK Package</b></p>				 <p style="text-align: center;"><b>SO-8 SA Package</b></p>			
ORDER NUMBER	PART MARKING	CARRIER	QUANTITY	ORDER NUMBER	PART MARKING	CARRIER	QUANTITY
TSM917EUK+T	TAAA	Tape & Reel	3000	TSM917ESA+	TS917E	Tube	97
				TSM917ESA+T		Tape & Reel	2500

**Lead-free Program:** Touchstone Semiconductor supplies only lead-free packaging.

Consult Touchstone Semiconductor for products specified with wider operating temperature ranges.

## ELECTRICAL CHARACTERISTICS

$V_{CC} = +5V$ ,  $V_{EE} = 0V$ ,  $V_{IN+} = V_{REF}$ ,  $T_A = -40^{\circ}C$  to  $+85^{\circ}C$ , unless otherwise noted. Typical values are at  $T_A = +25^{\circ}C$ . See Note 1.

PARAMETER	SYMBOL	CONDITIONS	MIN	TYP	MAX	UNITS
Supply Voltage Range	$V_{CC}$	Inferred from the PSRR test	$T_A = +25^{\circ}C$	1.8	5.5	V
Supply Current	$I_{CC}$	$V_{CC} = 1.6V$	$T_A = +25^{\circ}C$	0.75		$\mu A$
		$V_{CC} = 5V$	$T_A = +25^{\circ}C$	0.80	1.30	
			$T_A = T_{MIN}$ to $T_{MAX}$		1.60	
IN+ Voltage Range	$V_{IN+}$	Inferred from the output swing test	$V_{EE} - 0.2$		$V_{CC} + 0.2$	V
Input Offset Voltage	$V_{OS}$	(Note 2)	$T_A = +25^{\circ}C$	1	5	mV
			$T_A = T_{MIN}$ to $T_{MAX}$		10	
Input-Referred Hysteresis	$V_{HB}$	(Note 3)		4		mV
Input Bias Current	$I_B$	$T_A = +25^{\circ}C$		0.15	1	nA
		$T_A = T_{MIN}$ to $T_{MAX}$			2	
Power-Supply Rejection Ratio	PSRR	$V_{CC} = 1.8V$ to $5.5V$		0.1	1	mV/V
Output-Voltage Swing High	$V_{CC} - V_{OH}$	$V_{CC} = 5V$ , $I_{SOURCE} = 8mA$	$T_A = +25^{\circ}C$	190	400	mV
		$V_{CC} = 1.8V$ , $I_{SOURCE} = 1mA$	$T_A = T_{MIN}$ to $T_{MAX}$		500	
			$T_A = +25^{\circ}C$	55	200	
			$T_A = T_{MIN}$ to $T_{MAX}$		300	
Output-Voltage Swing Low	$V_{OL}$	$V_{CC} = 5V$ , $I_{SINK} = 8mA$	$T_A = +25^{\circ}C$	190	400	mV
		$V_{CC} = 1.8V$ , $I_{SINK} = 1mA$	$T_A = T_{MIN}$ to $T_{MAX}$		500	
			$T_A = +25^{\circ}C$	55	200	
			$T_A = T_{MIN}$ to $T_{MAX}$		300	
Output Short-Circuit Current	$I_{SC}$	Sourcing, $V_O = V_{EE}$	$V_{CC} = 5V$	95		mA
			$V_{CC} = 1.8V$	8		
		Sinking, $V_O = V_{CC}$	$V_{CC} = 5V$	98		
			$V_{CC} = 1.8V$	10		
High-to-Low Propagation Delay (Note 4)	$t_{PD-}$	$V_{CC} = 1.8V$		17		$\mu s$
		$V_{CC} = 5V$		22		
Low-to-High Propagation Delay (Note 4)	$t_{PD+}$		$V_{CC} = 1.8V$	30		$\mu s$
			$V_{CC} = 5V$	95		
Rise Time	$t_{RISE}$	$C_L = 15pF$		6		$\mu s$
Fall Time	$t_{FALL}$	$C_L = 15pF$		4		$\mu s$
Power-Up Time	$t_{ON}$			1.2		ms
Reference Voltage	$V_{REF}$	$T_A = +25^{\circ}C$	1.227	1.245	1.263	V
		$T_A = T_{MIN}$ to $T_{MAX}$	1.200		1.290	
Reference Voltage Temperature Coefficient	$TCV_{REF}$			95		ppm/ $^{\circ}C$
Reference Output Voltage Noise	$e_n$	$BW = 10Hz$ to $100kHz$		600		$\mu V_{RMS}$
		$BW = 10Hz$ to $100kHz$ , $C_{REF} = 1nF$		215		
Reference Line Regulation	$\Delta V_{REF} / \Delta V_{CC}$	$V_{CC} = 1.8V$ to $5.5V$		0.1		mV/V
Reference Load Regulation	$\Delta V_{REF} / \Delta I_{OUT}$	$\Delta I_{OUT} = 10nA$		$\pm 0.2$		mV/nA

**Note 1:** All specifications are 100% tested at  $T_A = +25^{\circ}C$ . Specification limits over temperature ( $T_A = T_{MIN}$  to  $T_{MAX}$ ) are guaranteed by design, not production tested.

**Note 2:**  $V_{OS}$  is defined as the center of the hysteresis band at the input.

**Note 3:** The hysteresis-related trip points are defined by the edges of the hysteresis band, measured with respect to the center of the hysteresis band (i.e.,  $V_{OS}$ ) (See Figure 2).

**Note 4:** Specified with an input overdrive ( $V_{OVERDRIVE}$ ) of 100mV, and load capacitance of  $C_L = 15pF$ .  $V_{OVERDRIVE}$  is defined above and beyond the offset voltage and hysteresis of the comparator input. For the TSM917, reference voltage error should also be added.

## TYPICAL PERFORMANCE CHARACTERISTICS

$V_{CC} = +5V$ ;  $V_{EE} = 0V$ ;  $C_L = 15pF$ ;  $V_{OVERDRIVE} = 100mV$ ;  $T_A = +25^\circ C$ , unless otherwise noted.

**Supply Current vs Supply Voltage and Temperature**

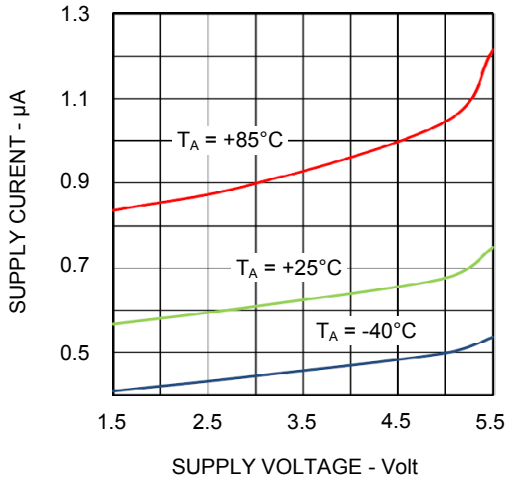

**Supply Current vs Temperature**

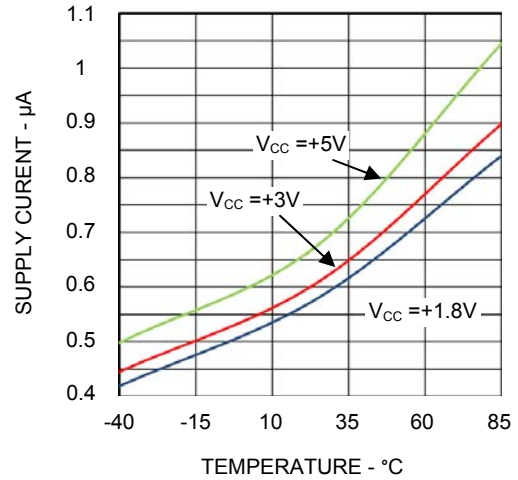

**Supply Current vs Output Transition Frequency**

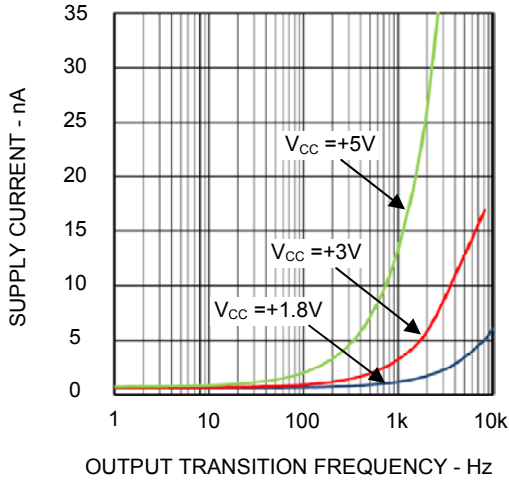

**Output Voltage Low vs. Sink Current**

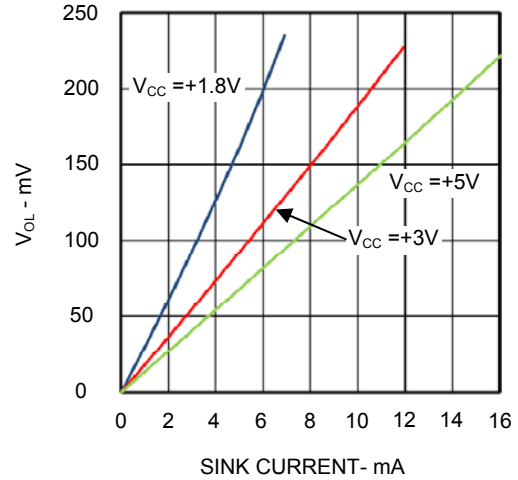

**Output Voltage Low vs. Sink Current and Temperature**

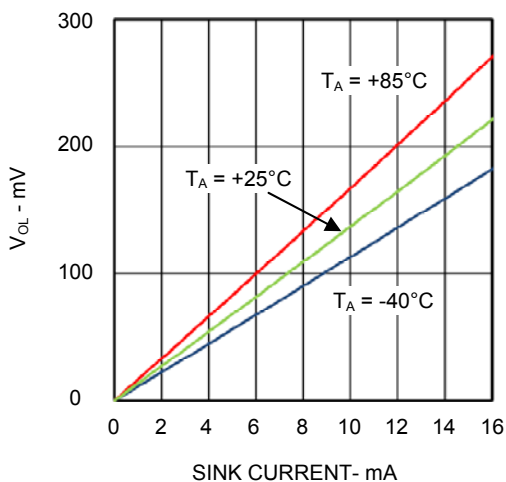

**Output Voltage High vs Source Current**

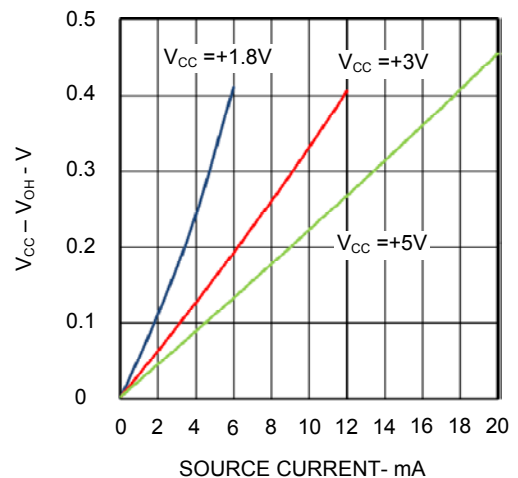

## TYPICAL PERFORMANCE CHARACTERISTICS

$V_{CC} = +5V$ ;  $V_{EE} = 0V$ ;  $C_L = 15pF$ ;  $V_{OVERDRIVE} = 100mV$ ;  $T_A = +25^\circ C$ , unless otherwise noted.

**Output Voltage High vs Source Current and Temperature**

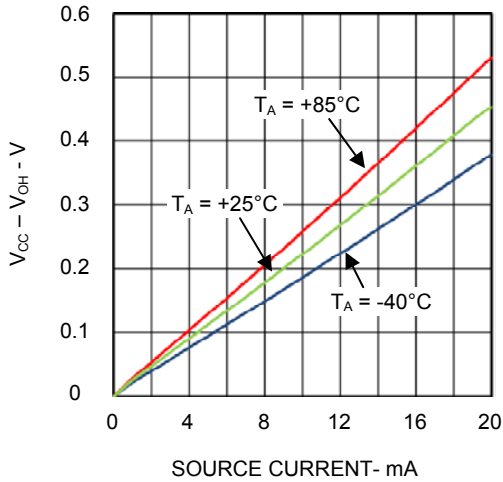

**Short-Circuit Sink Current vs Temperature**

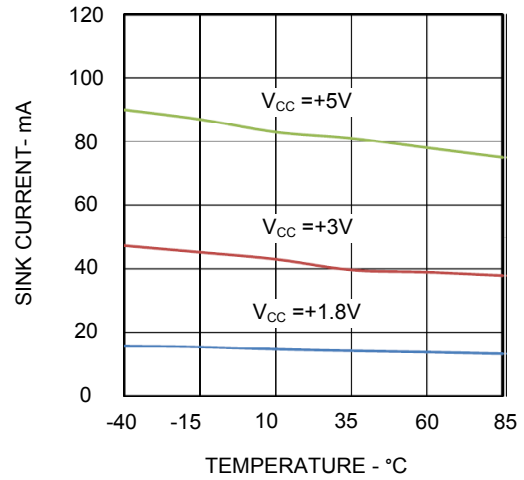

**Short-Circuit Source Current vs Temperature**

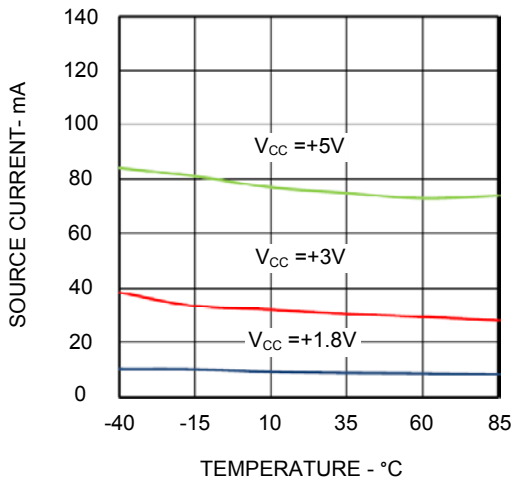

**Offset Voltage vs Temperature**

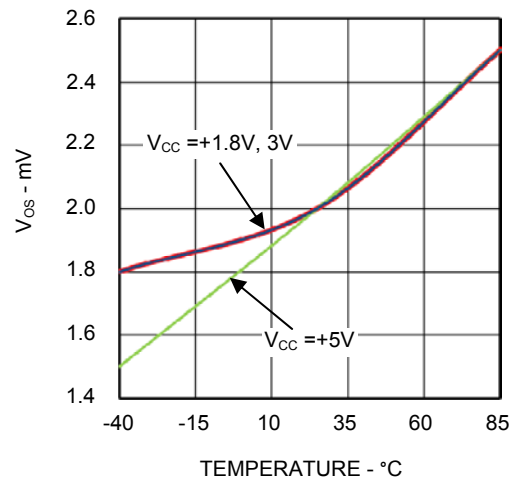

**Hysteresis Voltage vs Temperature**

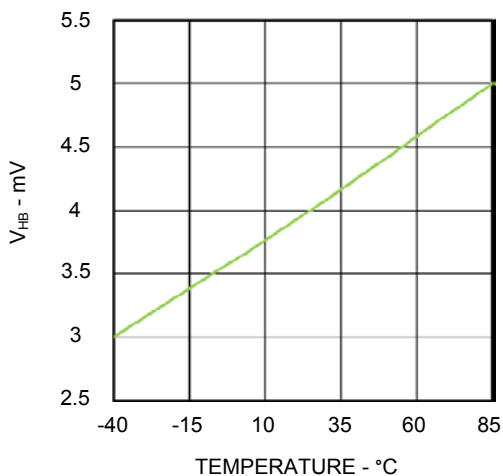

**Reference Voltage vs Temperature**

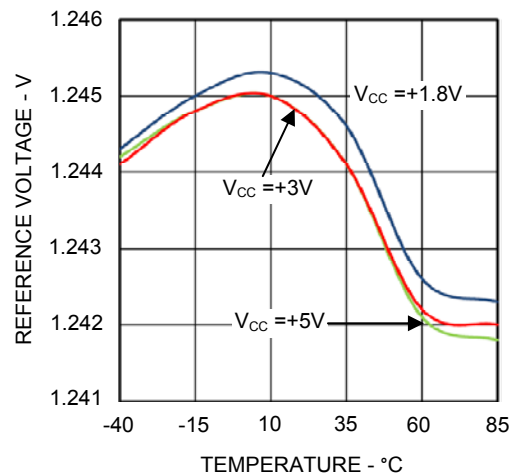

## TYPICAL PERFORMANCE CHARACTERISTICS

$V_{CC} = +5V$ ;  $V_{EE} = 0V$ ;  $C_L = 15pF$ ;  $V_{OVERDRIVE} = 100mV$ ;  $T_A = +25^\circ C$ , unless otherwise noted.

Reference Voltage vs Supply Voltage

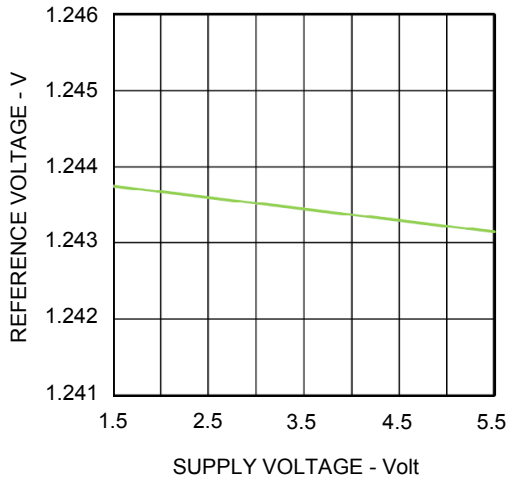

Reference Voltage vs Reference Source Current

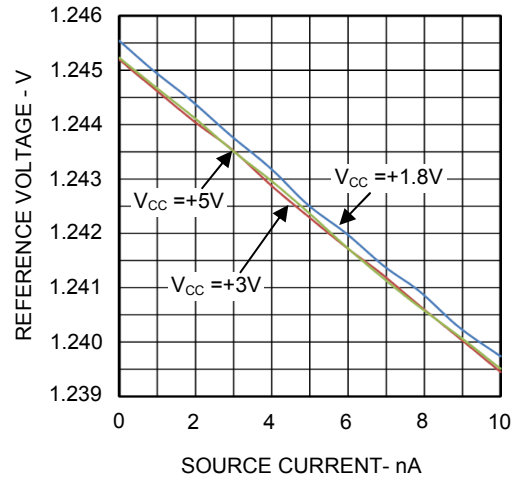

Reference Voltage vs Reference Sink Current

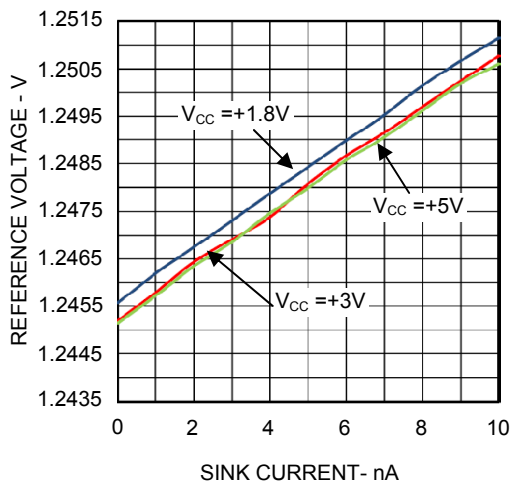

Propagation Delay ( $t_{PD}$ ) vs Temperature

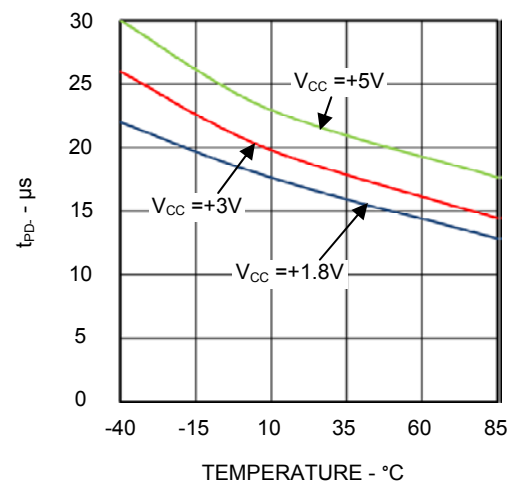

Propagation Delay ( $t_{PD+}$ ) vs Temperature

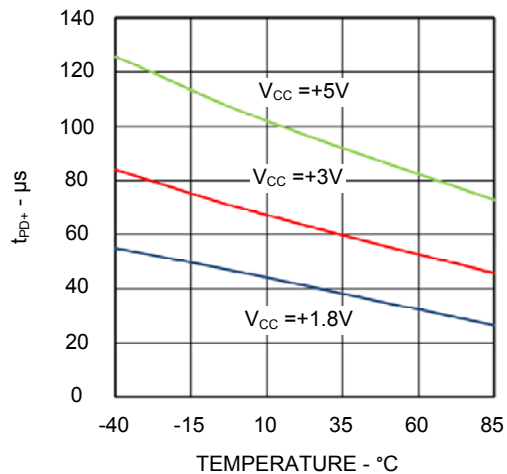

Propagation Delay ( $t_{PD}$ ) vs Capacitive Load

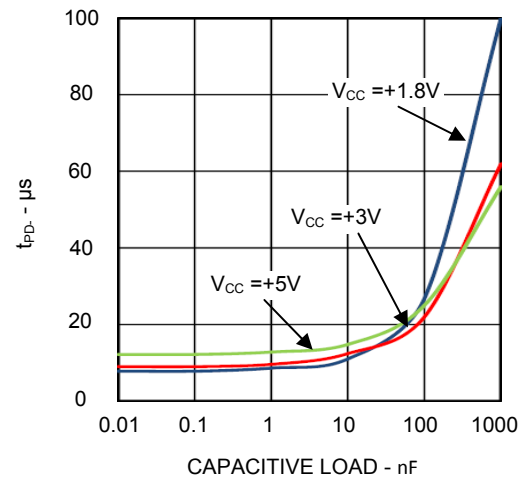

## TYPICAL PERFORMANCE CHARACTERISTICS

$V_{CC} = +5V$ ;  $V_{EE} = 0V$ ;  $C_L = 15pF$ ;  $V_{OVERDRIVE} = 100mV$ ;  $T_A = +25^{\circ}C$ , unless otherwise noted.

Propagation Delay ( $t_{PD+}$ ) vs Capacitive Load

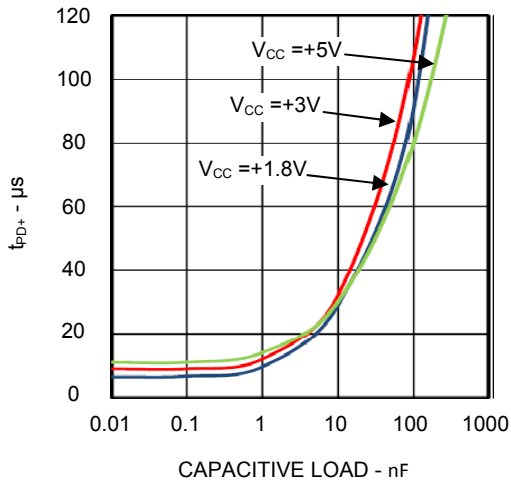

Propagation Delay ( $t_{PD+}$ ) vs Input Overdrive

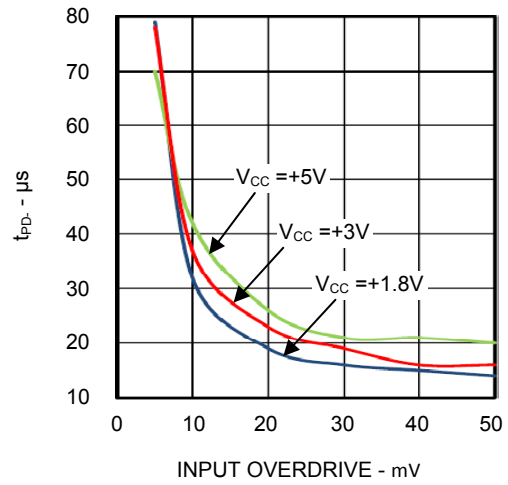

Propagation Delay ( $t_{PD+}$ ) vs Input Overdrive

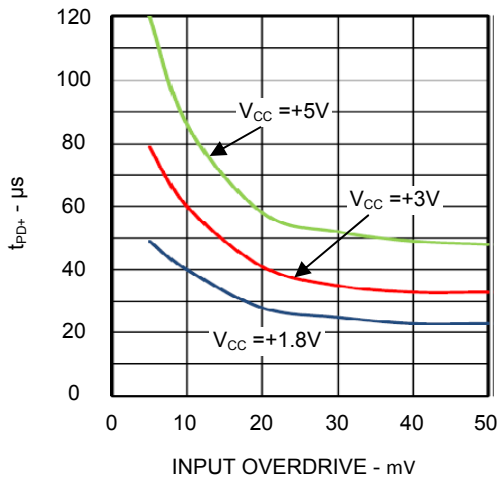

Propagation Delay ( $t_{PD+}$ ) at  $V_{CC} = +5V$

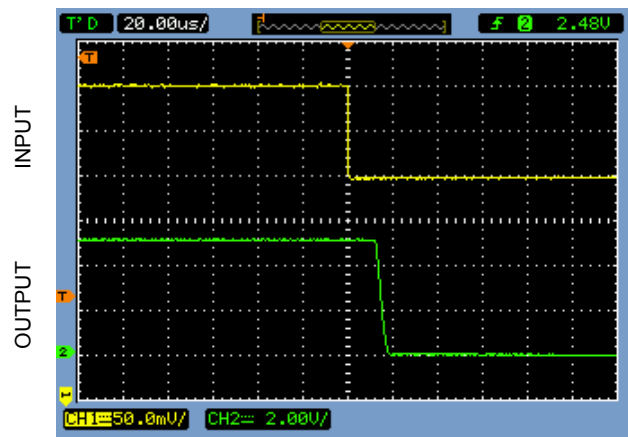

20  $\mu s$ /DIV

Propagation Delay ( $t_{PD+}$ ) at  $V_{CC} = +5V$

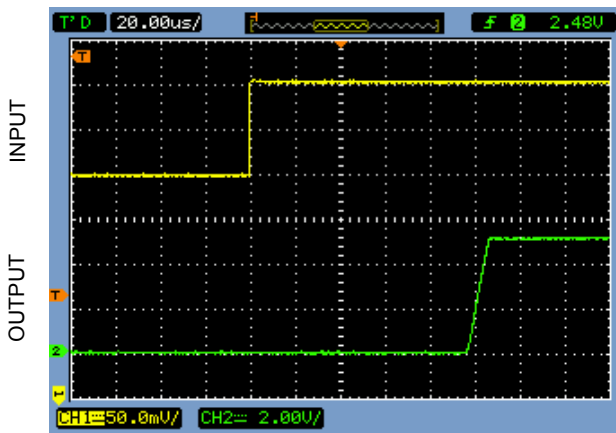

20  $\mu s$ /DIV

Propagation Delay ( $t_{PD+}$ ) at  $V_{CC} = +3V$

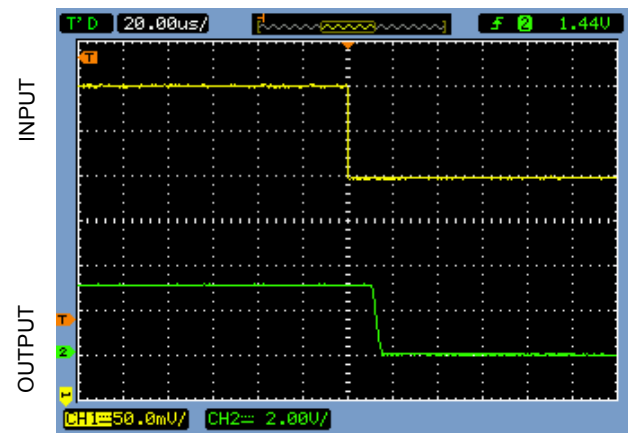

20  $\mu s$ /DIV

## TYPICAL PERFORMANCE CHARACTERISTICS

$V_{CC} = +5V$ ;  $V_{EE} = 0V$ ;  $C_L = 15pF$ ;  $V_{OVERDRIVE} = 100mV$ ;  $T_A = +25^{\circ}C$ , unless otherwise noted.

Propagation Delay ( $t_{PD+}$ ) at  $V_{CC} = +3V$

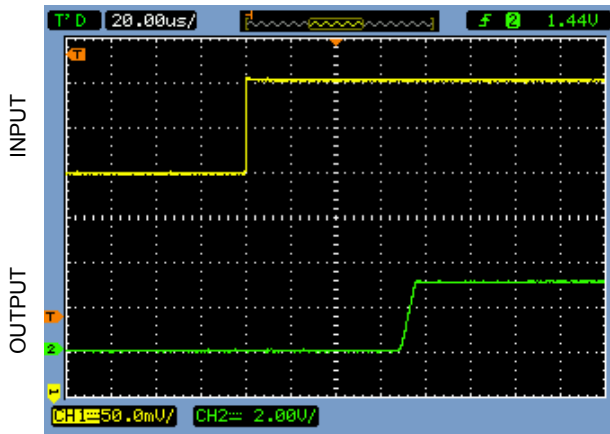

20 $\mu$ s/DIV

Propagation Delay ( $t_{PD-}$ ) at  $V_{CC} = +1.8V$

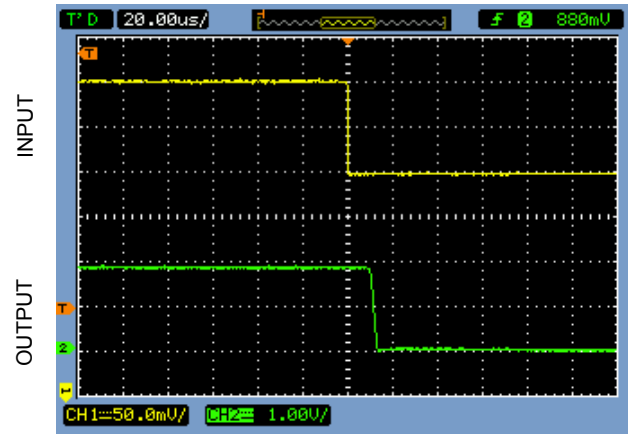

20 $\mu$ s/DIV

Propagation Delay ( $t_{PD+}$ ) at  $V_{CC} = +1.8V$

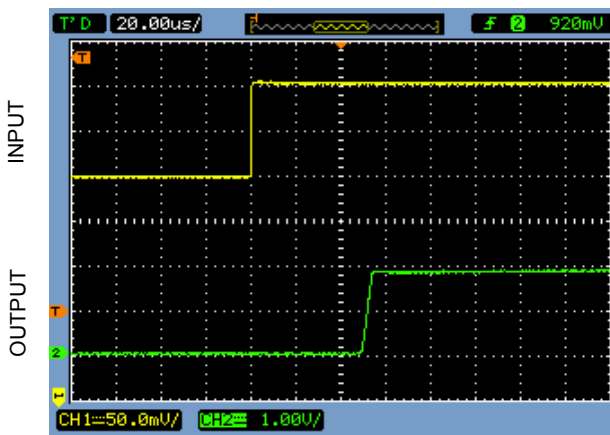

20 $\mu$ s/DIV

10kHz Transient Response at  $V_{CC} = +1.8V$

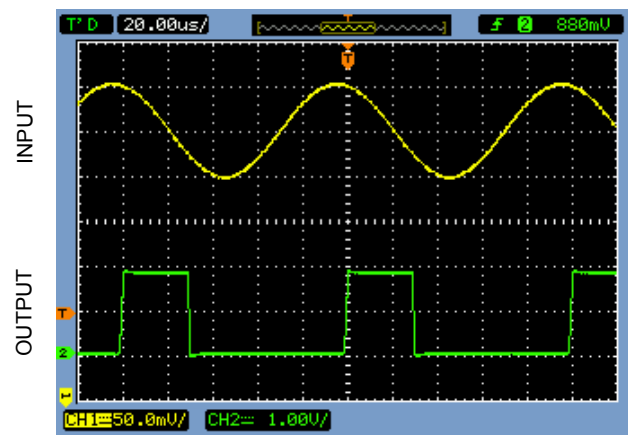

20 $\mu$ s/DIV

1kHz Transient Response at  $V_{CC} = +5V$

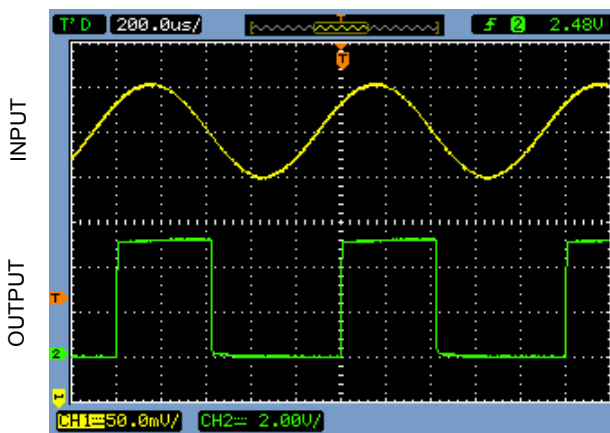

200 $\mu$ s/DIV

Power-Up/Power-Down Transient Response

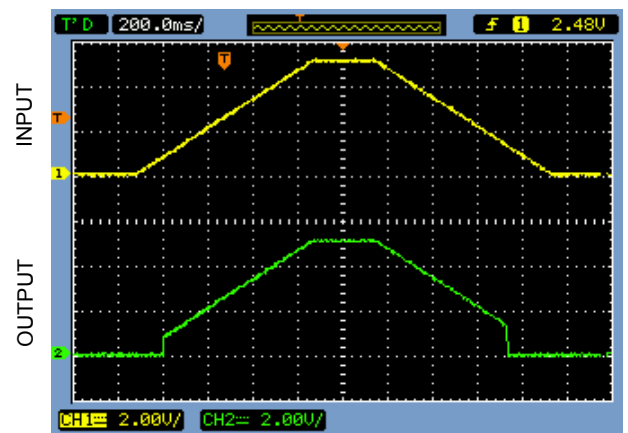

0.2s/DIV



## PIN FUNCTIONS

TSM917		NAME	FUNCTION
5-pin SOT23	8-pin SOIC		
1	6	OUT	Comparator Output
2	4	VEE	Negative Supply Voltage
3	3	IN+	Comparator Noninverting Input
4	2	REF	1.245V Reference Output and Comparator Inverting Input
5	7	VCC	Positive Supply Voltage
—	—	IN-	Comparator Inverting Input
—	1, 5, 8	NC	No Connection. Not internally connected.

## BLOCK DIAGRAMS

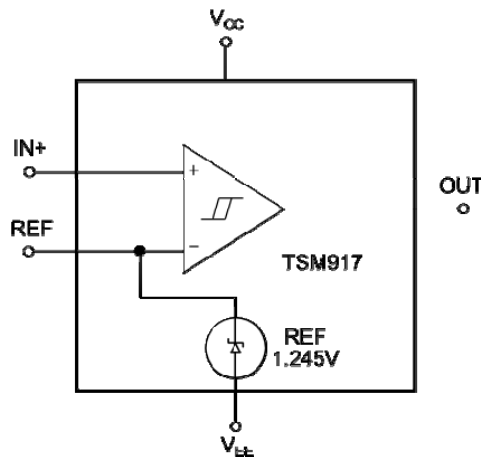

## DESCRIPTION OF OPERATION

Guaranteed to operate from +1.8V supplies, the TSM917 analog comparator only draws 750nA supply current, features a robust input stage that can tolerate input voltages 200mV beyond the power supply rails, and includes an on-board +1.245V  $\pm 1.5\%$  voltage reference. To insure clean output switching behavior, the TSM917 features 4mV internal hysteresis. The TSM917's push-pull output drivers were designed to minimize supply-current surges while driving  $\pm 8\text{mA}$  loads with rail-to-rail output swings.

### Input Stage Circuitry

The robust design of the analog comparator's input stage can accommodate any differential input voltage from  $V_{EE} - 0.2\text{V}$  to  $V_{CC} + 0.2\text{V}$ . Input bias currents are typically  $\pm 0.15\text{nA}$  so long as the applied input voltage remains between the supply rails. ESD protection diodes - connected internally to the supply rails - protect comparator inputs against overvoltage conditions. However, if the applied input voltage exceeds either or both supply rails, an increase in input current can occur when these ESD protection diodes start to conduct.

## Output Stage Circuitry

Many conventional analog comparators can draw orders of magnitude higher supply current when switching. Because of this behavior, additional power supply bypass capacitance may be required to provide additional charge storage during switching. The design of the TSM917's rail-to-rail output stage implements a technique that virtually eliminates supply-current surges when output transitions occur. As shown on Page 4 of the Typical Operating Characteristics, the supply-current change as a function of output transition frequency exhibited by this analog comparator family is very small. Material benefits of this attribute to battery-power applications are the increase in operating time and in reducing the size of power-supply filter capacitors.

### TSM917's Internal +1.245V $V_{REF}$

The TSM917's internal +1.245V voltage reference exhibits a typical temperature coefficient of 95ppm/°C over the full -40°C to +85°C temperature range. An equivalent circuit for the reference section is illustrated in Figure 1. Since the output impedance of the voltage reference is typically 200kΩ, its output

can be bypassed with a low-leakage capacitor and is stable for any capacitive load. An external buffer –

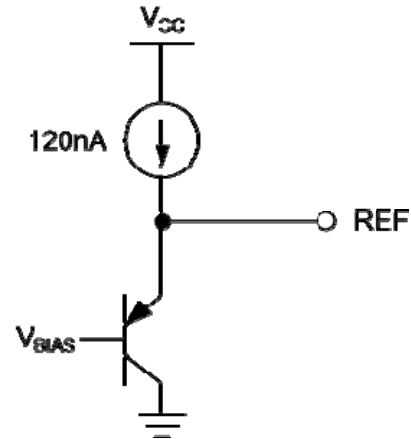

**Figure 1:** TSM917's Internal  $V_{REF}$  Output Equivalent Circuit

such as the TS1001 – can be used to buffer the voltage reference output for higher output current drive or to reduce reference output impedance.

## APPLICATIONS INFORMATION

### Low-Voltage, Low-Power Operation

Because it was designed specifically for any low-power, battery-operated application, the TSM917 analog comparator is an excellent choice. Under nominal conditions, approximate operating times for this analog comparator is illustrated in Table 1 for a number of battery types and their corresponding charge capacities.

### Internal Hysteresis

As a result of circuit noise or unintended parasitic feedback, many analog comparators often break into

oscillation within their linear region of operation especially when the applied differential input voltage approaches 0V (zero volt). Externally-introduced hysteresis is a well-established technique to stabilizing analog comparator behavior and requires external components. As shown in Figure 2, adding comparator hysteresis creates two trip points:  $V_{THR}$  (for the rising input voltage) and  $V_{THF}$  (for the falling input voltage). The hysteresis band ( $V_{HB}$ ) is defined as the voltage difference between the two trip points. When a comparator's input voltages are equal, hysteresis effectively forces one comparator input to

**Table 1: Battery Applications using the TSM917**

BATTERY TYPE	RECHARGEABLE	$V_{FRESH}$ (V)	$V_{END-OF-LIFE}$ (V)	CAPACITY, AA SIZE (mA-h)	TSM917 OPERATING TIME (hrs)
Alkaline (2 Cells)	No	3.0	1.8	2000	$2.5 \times 10^6$
Nickel-Cadmium (2 Cells)	Yes	2.4	1.8	750	937,500
Lithium-Ion (1 Cell)	Yes	3.5	2.7	1000	$1.25 \times 10^6$
Nickel-Metal- Hydride (2 Cells)	Yes	2.4	1.8	1000	$1.25 \times 10^6$

move quickly past the other input, moving the input out of the region where oscillation occurs. Figure 2 illustrates the case in which an IN- input is a fixed voltage and an IN+ is varied. If the input signals were reversed, the figure would be the same with an inverted output. To save cost and external pcb area, an internal 4mV hysteresis circuit was added to the TSM917.

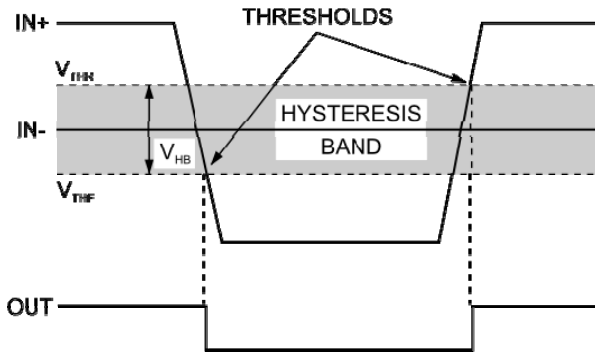

**Figure 2:** TSM917's Threshold Hysteresis Band

### Adding Hysteresis to the TSM917

The TSM917 exhibits an internal hysteresis band ( $V_{HB}$ ) of 4mV. Additional hysteresis can be generated with three external resistors using positive feedbacks as shown in Figure 3. Unfortunately, this method also reduces the hysteresis response time. The design procedure below can be used to calculate resistor values.

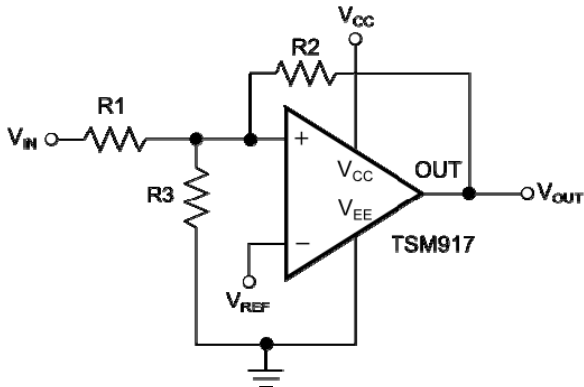

**Figure 3:** Using Three Resistors Introduces Additional Hysteresis in the TSM917.

- 1) Setting R2. As the leakage current at the IN pin is under 2nA, the current through R2 should be at least 0.2µA to minimize offset voltage errors caused by the input leakage current. The current through R2 at the trip

point is  $(V_{REF} - V_{OUT})/R2$ .

In solving for R2, there are two formulas – one each for the two possible output states:

$$R2 = V_{REF}/I_{R2}$$

or

$$R2 = (V_{CC} - V_{REF})/I_{R2}$$

From the results of the two formulae, the smaller of the two resulting resistor values is chosen. For example, when using the TSM917 ( $V_{REF} = 1.245V$ ) at a  $V_{CC} = 3.3V$  and if  $I_{R2} = 0.2\mu A$  is chosen, then the formulae above produce two resistor values: 6.23MΩ and 10.24MΩ - the 6.2MΩ standard value for R2 is selected.

- 2) Next, the desired hysteresis band ( $V_{HYSB}$ ) is set. In this example,  $V_{HYSB}$  is set to 100mV.
- 3) Resistor R1 is calculated according to the following equation:

$$R1 = R2 \times (V_{HB}/V_{CC})$$

and substituting the values selected in 1) and 2) above yields:

$$R1 = 6.2M\Omega \times (100mV/3.3V) = 187.88k\Omega$$

The 187kΩ standard value for R1 is selected.

- 4) The trip point for  $V_{IN}$  rising ( $V_{THR}$ ) is chosen such that  $V_{THR} > V_{REF} \times (R1 + R2)/R2$  (where  $V_{THF}$  is the trip point for  $V_{IN}$  falling). This is the threshold voltage at which the comparator switches its output from low to high as  $V_{IN}$  rises above the trip point. In this example,  $V_{THR}$  is set to 3V.
- 5) With the  $V_{THR}$  from Step 4 above, resistor R3 is then computed as follows:

$$R3 = 1/[V_{THR}/(V_{REF} \times R1) - (1/R1) - (1/R2)]$$

$$R3 = 1/[3V/(1.245V \times 187k\Omega) - (1/187k\Omega) - (1/6.2M\Omega)] = 135.56k\Omega$$

In this example, a 137kΩ, 1% standard value resistor is selected for R3.

- 6) The trip voltages and hysteresis band should be verified as follows:

$$\text{For } V_{IN} \text{ rising: } V_{THR} = V_{REF} \times R1 \times [(1/R1) + (1/R2) + (1/R3)] = 3V$$

$$\text{For } V_{IN} \text{ falling: } V_{THF} = V_{THR} - (R1 \times V_{CC}/R2) = 2.9V$$

$$\text{and Hysteresis Band} = V_{THR} - V_{THF} = 100mV$$

## PC Board Layout and Power-Supply Bypassing

While power-supply bypass capacitors are not typically required, it is always good engineering practice to use 0.1uF bypass capacitors close to the device's power supply pins when the power supply impedance is high, the power supply leads are long, or there is excessive noise on the power supply traces. To reduce stray capacitance, it is also good engineering practice to make signal trace lengths as short as possible. Also recommended are a ground plane and surface mount resistors and capacitors.

## PACKAGE OUTLINE DRAWING

### 5-Pin SOT23 Package Outline Drawing

(N.B., Drawings are not to scale)

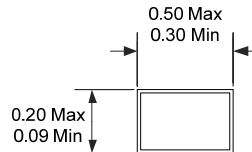
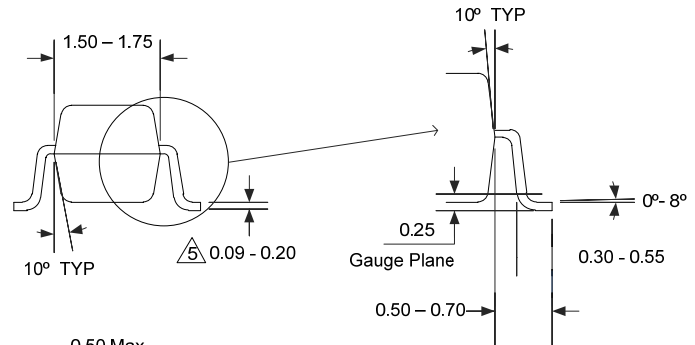
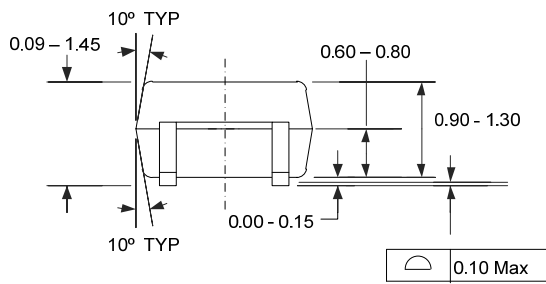
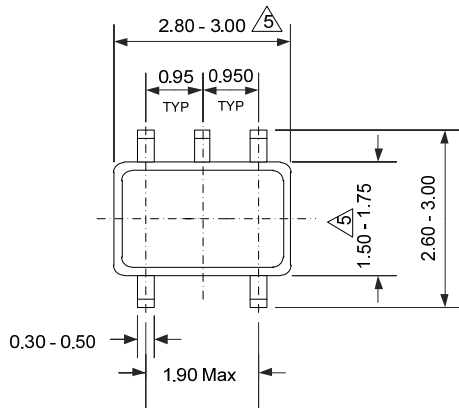

#### NOTES:

1. Dimensions and tolerances are as per ANSI Y14.5M, 1982.
2. Package surface to be matte finish VDI 11~13.
3. Die is facing up mold and facing down for trim/form, ie, reverse trim/form.
4. The foot length measuring is based on the gauge plane method.
5. Dimensions are exclusive of mold flash and gate burr.
6. Dimensions are exclusive of solder plating.
7. All dimensions are in mm.
8. This part is compliant with EIAJ spec. and JEDEC MO-178 AA
9. Lead span/stand off height/coplanarity are considered as special characteristic.

## PACKAGE OUTLINE DRAWING

### 8-Pin SOIC Package Outline Drawing

(N.B., Drawings are not to scale)

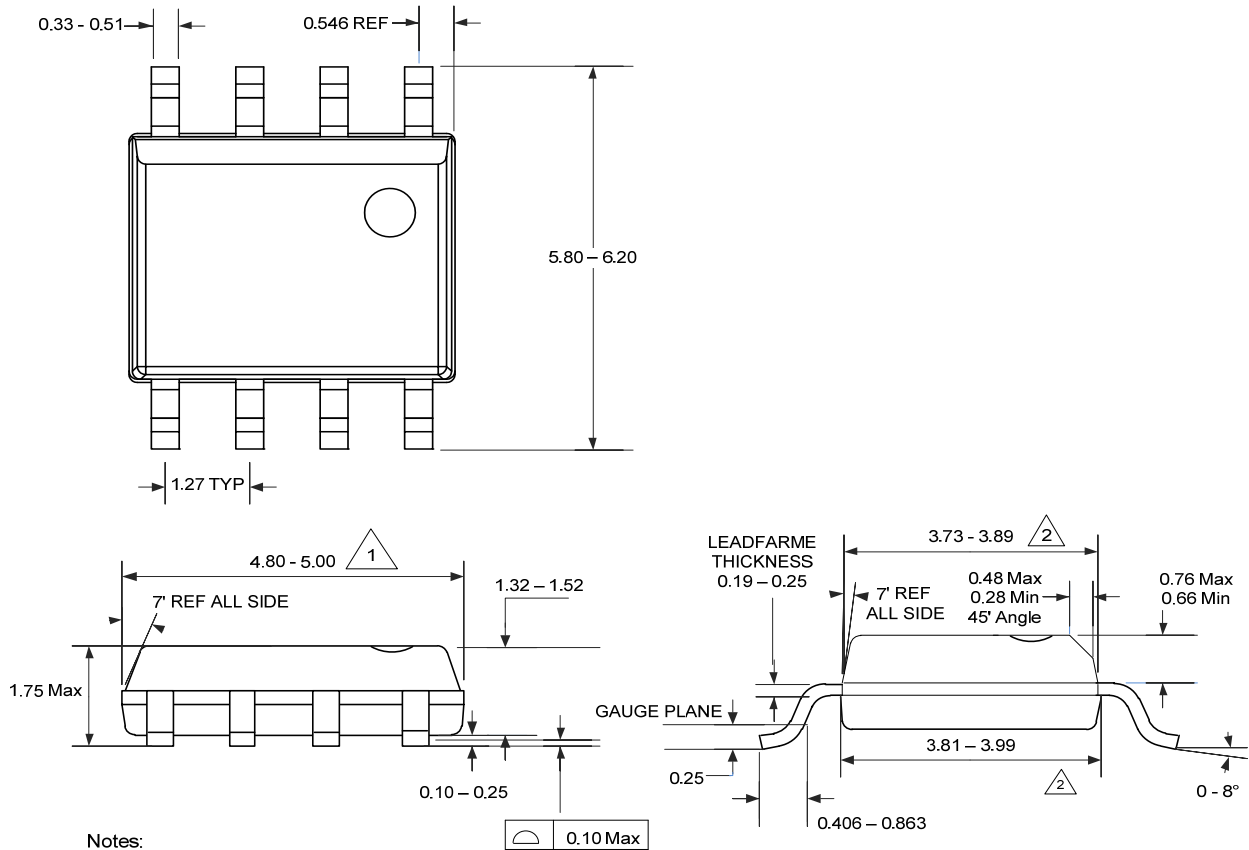

**Notes:**

- 1 Does not include mold flash, protrusions or gate burns. Mold flash, protrusions or gate burrs shall not exceed 0.15 mm per side.
- 2 Does not include inter-lead flash or protrusions. Inter-lead flash or protrusions shall not exceed 0.25 mm per side.
- 3. Lead span/stand off height/coplanarity are considered as special characteristic (s).
- 4. Controlling dimensions are in mm.
- 5. This part is compliant with JEDEC specification MS-012
- 6. Lead span/stand off height/coplanarity are considered as Special characteristic.

Information furnished by Touchstone Semiconductor is believed to be accurate and reliable. However, Touchstone Semiconductor does not assume any responsibility for its use nor for any infringements of patents or other rights of third parties that may result from its use, and all information provided by Touchstone Semiconductor and its suppliers is provided on an AS IS basis, WITHOUT WARRANTY OF ANY KIND. Touchstone Semiconductor reserves the right to change product specifications and product descriptions at any time without any advance notice. No license is granted by implication or otherwise under any patent or patent rights of Touchstone Semiconductor. Touchstone Semiconductor assumes no liability for applications assistance or customer product design. Customers are responsible for their products and applications using Touchstone Semiconductor components. To minimize the risk associated with customer products and applications, customers should provide adequate design and operating safeguards. Trademarks and registered trademarks are the property of their