

PLEASE CHECK WWW.MOLEX.COM FOR LATEST PART INFORMATION

Part Number: [0432238176](#)
Status: **Active**
Overview: [modular_plugs_jacks](#)
Description: Modular Jack, Right Angle, Low Profile, 8/8, 8 Ports

Documents:

[3D Model](#) [Product Specification PS-43223-001 \(PDF\)](#)
[Drawing \(PDF\)](#) [RoHS Certificate of Compliance \(PDF\)](#)

Agency Certification

CSA LR19980
 UL E107635

General

Product Family Modular Jacks/Plugs
 Series [43223](#)
 Comments Flush Mount|Flangeless|External Shield
 Component Type PCB Jack
 Magnetic No
 Overview [modular_plugs_jacks](#)
 Performance Category 3, 4
 Power over Ethernet (PoE) N/A
 Product Name RJ45

Physical

Boot Color N/A
 Color - Resin Black
 Durability (mating cycles max) 500
 Flammability 94V-0
 Inverted / Top Latch No
 Lightpipes/LEDs None
 Material - Metal Phosphor Bronze
 Material - Plating Mating Gold
 Material - Plating Termination Tin
 Material - Resin High Temperature Thermoplastic
 Orientation Right Angle (Side Entry)
 PCB Locator Yes
 PCB Retention Yes
 PCB Thickness Recommended (in) 0.062 In
 PCB Thickness Recommended (mm) 1.57 mm
 Packaging Type Tray
 Pitch - Mating Interface (in) 0.040 In
 Pitch - Mating Interface (mm) 1.02 mm
 Pitch - Term. Interface (in) 0.050 In
 Pitch - Term. Interface (mm) 1.27 mm
 Plating min: Mating (µin) 50
 Plating min: Mating (µm) 1.25
 Plating min: Termination (µin) 100
 Plating min: Termination (µm) 2.5
 Ports 8
 Positions / Loaded Contacts 8/8
 Surface Mount Compatible (SMC) No
 Temperature Range - Operating -40°C to +85°C
 Termination Interface: Style Through Hole
 Waterproof / Dustproof No
 Wire/Cable Type N/A



Series

image - Reference only

EU RoHS

**ELV and RoHS
 Compliant**
REACH SVHC
 Not Reviewed
**Halogen-Free
 Status**
Not Reviewed

China RoHS



**Need more information on product
 environmental compliance?**

Email productcompliance@molex.com
 For a multiple part number RoHS Certificate of
 Compliance, [click here](#)

Please visit the [Contact Us](#) section for any
 non-product compliance questions.

Search Parts in this Series

[43223Series](#)

Mates With

FCC 68 Plugs

Electrical

Current - Maximum per Contact	1.5A
Shielded	No
Voltage - Maximum	150V AC (RMS)

Solder Process Data

Duration at Max. Process Temperature (seconds)	5
Lead-free Process Capability	Wave Capable (TH only)
Max. Cycles at Max. Process Temperature	1
Process Temperature max. C	260

Material Info

Old Part Number	A432238176
-----------------	------------

Reference - Drawing Numbers

Product Specification	PS-43223-001
Test Summary	TS-43223-001

This document was generated on 06/07/2010

PLEASE CHECK WWW.MOLEX.COM FOR LATEST PART INFORMATION

- NOTES:
- MATERIAL:
 - HOUSING: GLASS FILLED NYLON, UL94V-0, COLOR: BLACK
 - INSULATOR: GLASS FILLED NYLON, UL94V-0, COLOR: BLACK
 - TERMINALS: PHOSPHOR BRONZE: .012/(0.30) THICK
 - FINISH:
 - TERMINALS:
 - SELECT GOLD IN CONTACT AREA: 50 MICROINCHES MIN.,
 - *SELECT TIN IN PC TAIL AREA: 100 MICROINCHES MIN.,
 - WITH OVERALL NICKEL UNDERPLATE: 50 MICROINCHES MIN.
 - *THE PRIMARY SHIPPING CARTON WILL BE LABELED 'COMPLIANT TO RoHS DIRECTIVE 2002/95/EC AND ELV ANNEX II OF DIRECTIVE 2000/53/EC'. CARTONS WITHOUT THIS LABEL MAY CONTAIN PRODUCT WITH TIN-LEAD IN THE PC TAIL AREA.
 - PRODUCT SPECIFICATION AND PROCESSING PARAMETERS: PS-43223-001.
 - ASSEMBLIES TO BE PACKAGED IN TRAYS, UNLESS OTHERWISE SPECIFIED.
 - SEE SHEETS 7-9 FOR P.C. BOARD LAYOUTS.
 - SEE SHEET 3 FOR THE SHIELDED JACK ASSEMBLY.
 - FOR 6 CIRCUIT JACKS CENTERLINE TO CENTERLINE SPACING IS .448/(11.38), FOR 8 CIRCUIT JACKS CENTERLINE TO CENTERLINE SPACING IS .550/(13.97).
 - ALL UNTOLERANCED DIMENSIONS ARE SHOWN FOR REFERENCE ONLY.

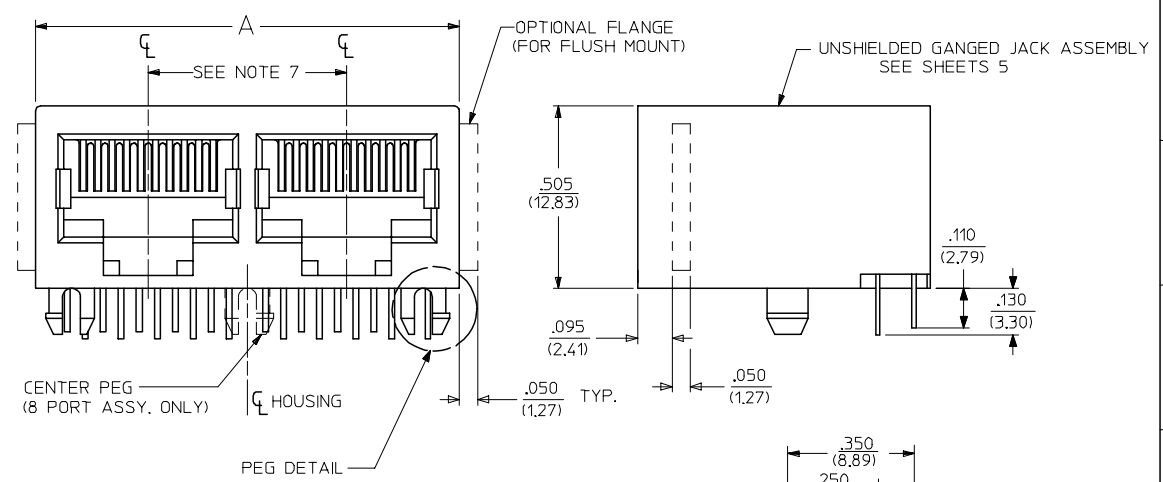

2 PORT 8 LOADED 10 JACK W/ SNAP-FIT PEGS SHOWN

6 CIRCUIT HOUSING

CIRCUIT SIZE	NO. OF PORTS	DIM. A	DIM. C	DIM. D
6	2	.985 (25.02)	.250 (6.35)	.848 (21.54)
4	2	.985 (25.02)	.150 (3.81)	.848 (21.54)
2	2	.985 (25.02)	.050 (1.27)	.848 (21.54)
6	3	1.433 (36.40)	.250 (6.35)	1.296 (32.92)
4	3	1.433 (36.40)	.150 (3.81)	1.296 (32.92)
2	3	1.433 (36.40)	.050 (1.27)	1.296 (32.92)
6	4	1.881 (47.78)	.250 (6.35)	1.744 (44.30)
4	4	1.881 (47.78)	.150 (3.81)	1.744 (44.30)
2	4	1.881 (47.78)	.050 (1.27)	1.744 (44.30)
6	5	2.329 (59.16)	.250 (6.35)	2.192 (55.68)
4	5	2.329 (59.16)	.150 (3.81)	2.192 (55.68)
2	5	2.329 (59.16)	.050 (1.27)	2.192 (55.68)
6	6	2.777 (70.54)	.250 (6.35)	2.640 (67.06)
4	6	2.777 (70.54)	.150 (3.81)	2.640 (67.06)
2	6	2.777 (70.54)	.050 (1.27)	2.640 (67.06)
6	8	3.673 (93.29)	.250 (6.35)	3.536 (89.81)
4	8	3.673 (93.29)	.150 (3.81)	3.536 (89.81)
2	8	3.673 (93.29)	.050 (1.27)	3.536 (89.81)

8 CIRCUIT HOUSING

CIRCUIT SIZE	NO. OF PORTS	DIM. A	DIM. C	DIM. D
10	2	1.200 (30.48)	.450 (11.43)	1.000 (25.40)
8	2	1.200 (30.48)	.350 (8.89)	1.000 (25.40)
6	2	1.200 (30.48)	.250 (6.35)	1.000 (25.40)
10	3	1.750 (44.45)	.450 (11.43)	1.550 (39.37)
8	3	1.750 (44.45)	.350 (8.89)	1.550 (39.37)
6	3	1.750 (44.45)	.250 (6.35)	1.550 (39.37)
4	3	1.750 (44.45)	.150 (3.81)	1.550 (39.37)
10	4	2.300 (58.42)	.450 (11.43)	2.100 (53.34)
8	4	2.300 (58.42)	.350 (8.89)	2.100 (53.34)
4	4	2.300 (58.42)	.150 (3.81)	2.100 (53.34)
4	5	2.850 (72.39)	.150 (3.81)	2.650 (67.31)
10	5	2.850 (72.39)	.450 (11.43)	2.650 (67.31)
8	5	2.850 (72.39)	.350 (8.89)	2.650 (67.31)
10	6	3.400 (86.36)	.450 (11.43)	3.200 (81.28)
8	6	3.400 (86.36)	.350 (8.89)	3.200 (81.28)
10	8	4.500 (114.30)	.450 (11.43)	4.300 (109.22)
8	8	4.500 (114.30)	.350 (8.89)	4.300 (109.22)

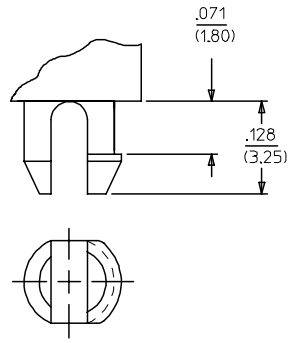

PEG DETAIL
SCALE: 8:1

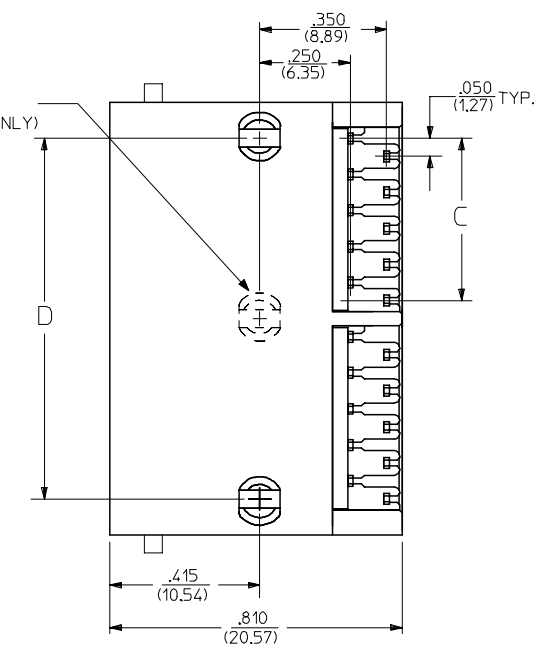

9	J1
8	J1
7	J1
6	H
5	H
4	J
3	J
2	J
1	J1
SH	REV

ADD PCB THICKNESS EC NO: UCP/2005-2739 DRW/LLSCHMIDT 2005/06/20 CHKD:ELHAG 2005/06/22 APPR:FSMITH 2005/06/23 J1	QUALITY SYMBOLS ▽ = 0 ▽ = 0	GENERAL TOLERANCES (UNLESS SPECIFIED) mm INCH 4 PLACES ± --- ± --- 3 PLACES ± --- ± --- 2 PLACES ± --- ± --- 1 PLACE ± --- ± --- ANGULAR ±1/2° DRAFT WHERE APPLICABLE MUST REMAIN WITHIN DIMENSIONS	SCALE 4:1 DESIGN UNITS INCH DIMENSION STYLE IN/MM DRAWN BY JTR DATE 10/18/1993 CHECKED BY JTR DATE 10/18/1993 APPROVED BY RAS DATE 10/18/1993	THIRD ANGLE PROJECTION REVISE ON CAD ONLY TITLE LOW PROFILE GANGED, RIGHT ANGLE MODULAR JACK ASSEMBLY MOLEX MOLEX INCORPORATED MATERIAL NO. SEE SHEET 5 DOCUMENT NO. SDA-43223 SHEET NO. 1 OF 9
	THIS DRAWING CONTAINS INFORMATION THAT IS PROPRIETARY TO MOLEX INCORPORATED AND SHOULD NOT BE USED WITHOUT WRITTEN PERMISSION			
	THIS DRAWING CONTAINS INFORMATION THAT IS PROPRIETARY TO MOLEX INCORPORATED AND SHOULD NOT BE USED WITHOUT WRITTEN PERMISSION			
	THIS DRAWING CONTAINS INFORMATION THAT IS PROPRIETARY TO MOLEX INCORPORATED AND SHOULD NOT BE USED WITHOUT WRITTEN PERMISSION			

FLUSH MOUNT (UNSHIELDED)

FLANGELESS (UNSHIELDED)

ASSEMBLY NUMBER	CONNECTOR SIZE	NUMBER OF CIRCUITS	NUMBER OF PORTS	PACKAGING STYLE	PACKAGING SPECIFICATION
43223-6001	6	6	2	TRAY	PK-43249-004
43223-6004	6	6	3	↑	↑
43223-6007	6	6	4		
43223-6010	6	6	5		
43223-6013	6	6	6		
43223-6019	6	6	8		
43223-6022	6	4	2		
43223-6025	6	4	3		
43223-6028	6	4	4		
43223-6031	6	4	5		
43223-6034	6	4	6		
43223-6040	6	4	8		
43223-6043	6	2	2		
43223-6046	6	2	3		
43223-6049	6	2	4		
43223-6052	6	2	5		
43223-6055	6	2	6		
43223-6058	6	2	8	TRAY	PK-43249-004

ASSEMBLY NUMBER	CONNECTOR SIZE	NUMBER OF CIRCUITS	NUMBER OF PORTS	PACKAGING STYLE	PACKAGING SPECIFICATION
43223-6101	6	6	2	TRAY	PK-43249-004
43223-6104	6	6	3	↑	↑
43223-6107	6	6	4		
43223-6110	6	6	5		
43223-6113	6	6	6		
43223-6119	6	6	8		
43223-6122	6	4	2		
43223-6125	6	4	3		
43223-6128	6	4	4		
43223-6131	6	4	5		
43223-6134	6	4	6		
43223-6140	6	4	8		
43223-6143	6	2	2		
43223-6146	6	2	3		
43223-6149	6	2	4		
43223-6152	6	2	5		
43223-6155	6	2	6		
43223-6158	6	2	8	TRAY	PK-43249-004

43223-8001	8	10	2	TRAY	PK-43249-004
43223-8004	8	10	3	↑	↑
43223-8007	8	10	4		
43223-8010	8	10	5		
43223-8013	8	10	6		
43223-8019	8	10	8		
43223-8022	8	8	2		
43223-8025	8	8	3		
43223-8028	8	8	4		
43223-8031	8	8	5		
43223-8034	8	8	6		
43223-8040	8	8	8		
43223-8041	8	4	5	↓	↓
43223-8042	8	6	3	TRAY	PK-43249-004

43223-8101	8	10	2	TRAY	PK-43249-004
43223-8104	8	10	3	↑	↑
43223-8107	8	10	4		
43223-8110	8	10	5		
43223-8113	8	10	6		
43223-8119	8	10	8		
43223-8122	8	8	2		
43223-8131	8	8	3		
43223-8140	8	8	4		
43223-8149	8	8	5		
43223-8158	8	8	6		
43223-8176	8	8	8	TRAY	PK-43249-004

43223-8191	8	6	2	TUBE	PK-43249-005
43223-8192	8	4	4	TUBE	PK-43249-005
43223-8193	8	4	3	TUBE	PK-43249-005
43223-8195	8	8	2	TUBE	PK-43249-005
43223-8196	8	8	3	TUBE	PK-43249-005
43223-8197	8	8	4	TUBE	PK-43249-005

FLANGELESS (SHIELDED)

ASSEMBLY NUMBER	DIMENSION "B"	CONNECTOR SIZE	NUMBER OF CIRCUITS	NUMBER OF PORTS	NUMBER OF REAR SHIELD GROUND TABS	PACKAGING STYLE	PACKAGING SPECIFICATION
43223-8128	.180	8	8	2	1	TRAY	PK-44150-004
43223-8146	.180	8	8	4	3	↑	↑
43223-8164	.180	8	8	6	5		
43223-8182	.180	8	8	8	7		
43223-8185	.180	8	8	8	1		
43223-8188	.180	8	8	4	1	↓	↓
43223-8194	.180	8	2	8	7	TRAY	PK-44150-004

43223-8301	.145	8	8	2	1	TRAY	PK-44150-004
43223-8302	.145	8	8	4	3	↑	↑
43223-8303	.145	8	8	6	5		
43223-8304	.145	8	8	8	7		
43223-8305	.145	8	8	8	1		
43223-8306	.145	8	8	4	1	↓	↓
43223-8307	.145	8	2	8	7	TRAY	PK-44150-004

SNAP FIT PEG VERSIONS

SEE SHEET ONE EC NO: UCP/004-0870 DRWN:LSCHMDT 2004/01/02 CHKD:LSCHMDT 2004/01/02 APPR:FSMITH 2004/01/09	QUALITY SYMBOLS	GENERAL TOLERANCES (UNLESS SPECIFIED)	SCALE 4:1	DESIGN UNITS INCH	THIRD ANGLE PROJECTION	REVISE ON CAD ONLY
	▽ = 0 ▽ = 0	mm	INCH	DIMENSION STYLE		TITLE
		4 PLACES ± .0004	± .0004	IN/MM		LOW PROFILE RIGHT ANGLE GANGED MODULAR JACK ASSEMBLY
		3 PLACES ± .0008	± .0008	DRAWN BY JTR	DATE 10/12/1993	
2 PLACES ± .0016	± .0016	CHECKED BY JTR		DATE 10/12/1993	MOLEX INCORPORATED	
1 PLACE ± .0032	± .0032	APPROVED BY RAS		DATE 10/12/1993		
DRAFT WHERE APPLICABLE MUST REMAIN WITHIN DIMENSIONS		THIS DRAWING CONTAINS INFORMATION THAT IS PROPRIETARY TO MOLEX INCORPORATED AND SHOULD NOT BE USED WITHOUT WRITTEN PERMISSION		MATERIAL NO. SEE CHART	DOCUMENT NO. SDA-43223	SHEET NO. 5 OF 9

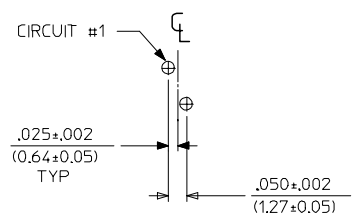

8 LOADED 2 DETAIL
SCALE: 4/1

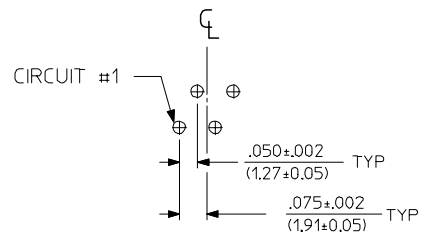

8 LOADED 4 DETAIL
SCALE: 4/1

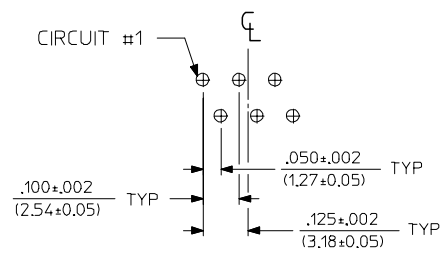

8 LOADED 6 DETAIL
SCALE: 4/1

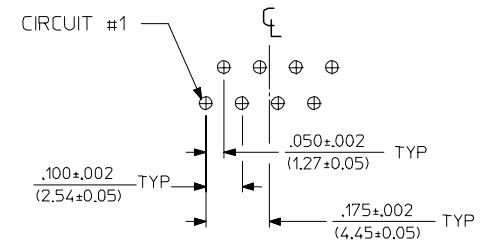

8 LOADED 8 DETAIL
SCALE: 4/1

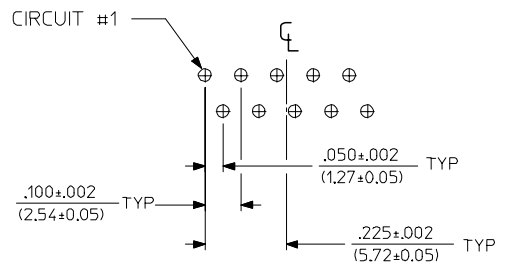

8 LOADED 10 DETAIL
SCALE: 4/1

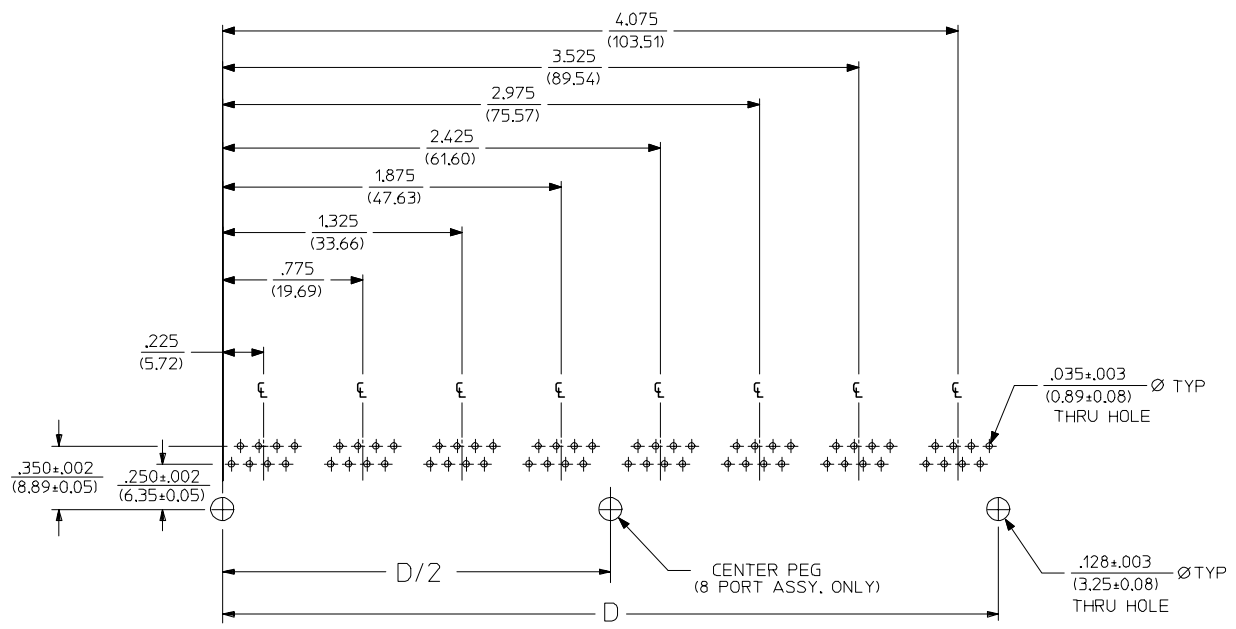

SUGGESTED P.C. BOARD LAYOUT
COMPONENT SIDE OF BOARD
8 PORT, 8 LOADED 8
(SNAP-FIT & PRESS-FIT VERSIONS)

NOTES:
1. RECOMMENDED PCB THICKNESS: .062±.005/(1.57±0.13)

NUMBER OF PORTS	DIM. D
2	1,000 (25.40)
3	1,550 (39.37)
4	2,100 (53.34)
5	2,650 (67.31)
6	3,200 (81.28)
8	4,300 (109.32)

ADD PCB THICKNESS EC NO: UCP2005-7739 DRW: NLSCHMIDT 2005/06/20 CHKD: ELHAG 2005/06/22 APPR: FSMITH 2005/06/23	QUALITY SYMBOLS	GENERAL TOLERANCES (UNLESS SPECIFIED)	SCALE 2:1	DESIGN UNITS INCH	THIRD ANGLE PROJECTION	REVISE ON CAD ONLY	
	DESCRIPTION J1	4 PLACES ± --- ± --- 3 PLACES ± --- ± .005 2 PLACES ± 0.13 ± .01 1 PLACE ± 0.25 ± --- ANGULAR ±1/2°	DIMENSION STYLE IN/MM		TITLE		
		DRAFT WHERE APPLICABLE MUST REMAIN WITHIN DIMENSIONS		DRAWN BY JTR	DATE 10/12/1993	LOW PROFILE RIGHT ANGLE GANGED MODULAR JACK ASSEMBLY	
		THIS DRAWING CONTAINS INFORMATION THAT IS PROPRIETARY TO MOLEX INCORPORATED AND SHOULD NOT BE USED WITHOUT WRITTEN PERMISSION		CHECKED BY JTR	DATE 10/12/1993	MOLEX MOLEX INCORPORATED	
		APPROVED BY RAS	DATE 10/12/1993	MATERIAL NO. SEE SHT 5,6	DOCUMENT NO. SDA-43223	SHEET NO. 8 OF 9	