



### Features

- WCDMA Power at 2140MHz = 20dBm with -60dBc ACPR
- Gain = 13dB at 2140MHz
- P1dB = 32.5dBm at 2140MHz
- Externally Matched
- Power-down capability
- Class 1C HBM ESD Rating
- On-chip Input Power Detector

### Applications

- 2G, 3G, and 4G Air Interfaces
- Driver Amplifier for Commercial Wireless Infrastructure
- Picocell, Femtocell Power Amplifier
- WCDMA, LTE, TD-SCDMA, GSM

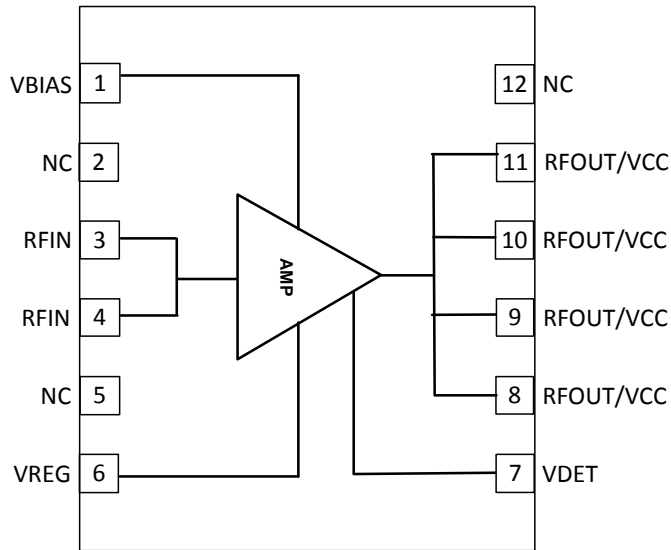

Functional Block Diagram

### Product Description

The RFPA2235 is a single-stage InGaP HBT power amplifier. It exhibits excellent back-off characteristics making it ideal for ultra-linear driver amplifier applications. The RFPA2235 can also be optimized for use as a small-cell PA output stage. External matching and bias control allows the RFPA2235 to be utilized across various radio platforms within 700MHz to 2700MHz. The PA2235 offers a robust Class 1C (>1000V) HBM ESD rating in a compact 4mm x 5mm DFN package.

### Ordering Information

RFPA2235SR	7" Reel with 100 pieces
RFPA2235SQ	Sample bag with 25 pieces
RFPA2235TR13	13" Reel with 2500 pieces
RFPA2235PCK-410	728MHz to 768MHz PCBA with 5-piece sample bag
RFPA2235PCK-411	2110MHz to 2170MHz PCBA with 5-piece sample bag
RFPA2235PCK-412	2580MHz to 2690MHz PCBA with 5-piece sample bag

## Absolute Maximum Ratings

Parameter	Rating	Unit
Supply Voltage ( $V_{CC}$ and $V_{BIAS}$ )	7.0	V
Collector Current	1500	mA
CW Input Power, 50Ω	33	dBm
Modulated (WCDMA) Input Power, 6:1 Output VSWR	18	dBm
Operating Junction Temperature ( $T_J$ )	165	°C
Operating Temperature Range ( $T_L$ )	-40 to +85	°C
Storage Temperature	-40 to +150	°C
ESD Rating: Human Body Model (HBM)	Class 1C	
Moisture Sensitivity Level	MSL1	



**Caution!** ESD sensitive device.

Exceeding any one or a combination of the Absolute Maximum Rating conditions may cause permanent damage to the device. Extended application of Absolute Maximum Rating conditions to the device may reduce device reliability. Specified typical performance or functional operation of the device under Absolute Maximum Rating conditions is not implied.

The information in this publication is believed to be accurate and reliable. However, no responsibility is assumed by RF Micro Devices, Inc. ("RFMD") for its use, nor for any infringement of patents, or other rights of third parties, resulting from its use. No license is granted by implication or otherwise under any patent or patent rights of RFMD. RFMD reserves the right to change component circuitry, recommended application circuitry and specifications at any time without prior notice.



RFMD Green: RoHS compliant per EU Directive 2002/95/EC, halogen free per IEC 61249-2-21, < 1000ppm each of antimony trioxide in polymeric materials and red phosphorus as a flame retardant, and <2% antimony in solder.

- Notes: 1. The maximum ratings must all be met simultaneously.  
 2.  $P_{DISS} = P_{DC} + P_{RFIN} - P_{RFOUT}$   
 3.  $T_J = T_L + P_{DISS} * R_{TH}$

Parameter	Specification			Unit	Condition
	Min.	Typ.	Max.		
<b>728MHz to 768MHz</b>					$V_{CC} = 5.0V$ , Temp = 25 °C, Optimized for -60dBc ACPR power
Frequency		748		MHz	
Input Power ( $P_{IN}$ )			15	dBm	Max Recommended Continuous CW Input Power, $V_{CC}=5.0V$ , Load VSWR=2:1
Gain (S21)	14.2	15.7	17.2	dB	
ACPR		-60.5	-55	dBc	RF Output Power = 18dBm, WCDMA 3GPP 3.5, test model 1, 64 DPCH
P1dB		32		dBm	
OIP3		45		dBm	15dBm per tone, 1MHz Spacing. Optimized for best ACPR.
Input Return Loss (S11)		18		dB	
Output Return Loss (S22)		10		dB	
Noise Figure		8		dB	
<b>2.11GHz to 2.17GHz</b>					$V_{CC} = 5.0V$ , Temp = 25 °C, Optimized for -60dBc ACPR power
Frequency		2.14		GHz	
Input Power ( $P_{IN}$ )			16	dBm	Max Recommended Continuous CW Input Power, $V_{CC}=5.0V$ , Load VSWR=2:1
Gain (S21)	11.5	13	15.5	dB	
ACPR		-61	-55	dBc	RF Output Power = 20dBm, WCDMA 3GPP 3.5, test model 1, 64 DPCH
P1dB		32.8		dBm	
OIP3		47		dBm	15dBm per tone, 1MHz Spacing. Optimized for best ACPR.
Input Return Loss (S11)		18		dB	
Output Return Loss (S22)		15		dB	
Noise Figure		5		dB	

Parameter	Specification			Unit	Condition
	Min.	Typ.	Max.		
<b>2.58GHz to 2.69GHz</b>					$V_{CC} = 5.0V$ , Temp = 25°C, Optimized for -60dBc ACPR power
Frequency		2.64		GHz	
Input Power ( $P_{IN}$ )			17	dBm	Max Recommended Continuous CW Input Power, $V_{CC}=5.0V$ , Load VSWR=2:1
Gain (S21)	10.7	12.2	13.7	dB	
ACPR		-60	-55	dBm	RF Output Power = 19dBm, WCDMA 3GPP 3.5, test model 1, 64 DPCH
P1dB		31		dBm	
OIP3		44		dBm	15dBm per tone, 1MHz Spacing. Optimized for best ACPR.
Input Return Loss (S11)		18		dB	
Output Return Loss (S22)		10		dB	
Noise Figure		5.4		dB	
<b>Power Supply</b>					$V_{CC} = 5.0V$ , Bias Conditions
Collector Current (Quiescent)	400	455	525	mA	At $V_{CC} = 5.0V$ , Temp = 25°C, optimized for max PAE at rated linear power
Collector Voltage ( $V_{CC}$ )	4.75	5	5.25	V	
$V_{BIAS}$	4.75	5	5.25	V	$V_{BIAS} = V_{CC}$ under normal operating condition
$V_{REG}$	5	5	5	V	Normal operating condition
Collector Leakage Current (shutdown)			100	$\mu A$	$V_{CC} = V_{BIAS} = 5V$ , $V_{REG} = 0V$
Thermal Resistance ( $R_{TH}$ )		14		°C/W	Junction-to-backside of package

## Typical Performance

( $V_{CC}=V_{BIAS}=V_{REG}=5V$ , 728MHz to 768MHz Application Circuit)

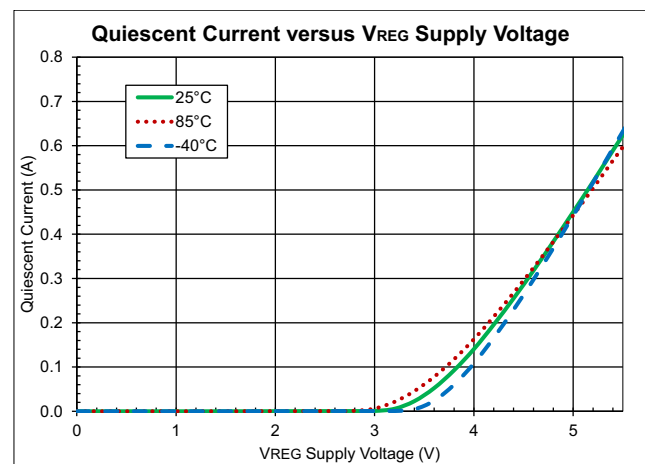
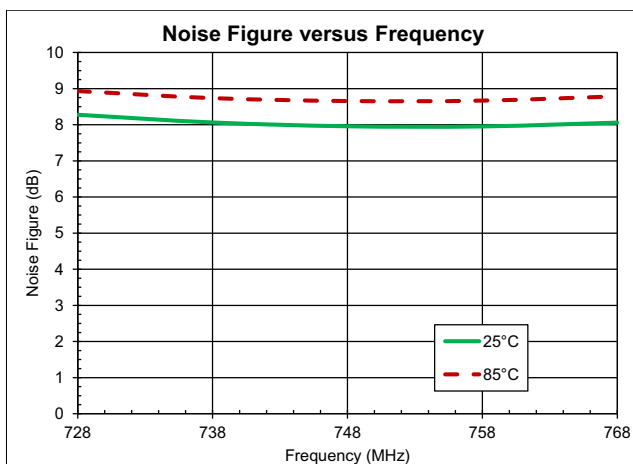
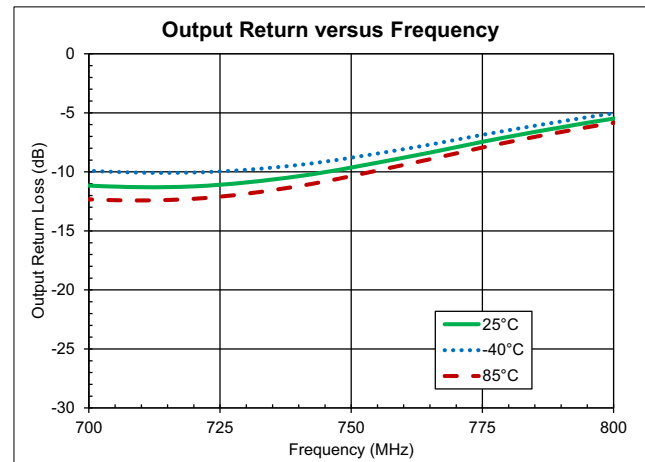
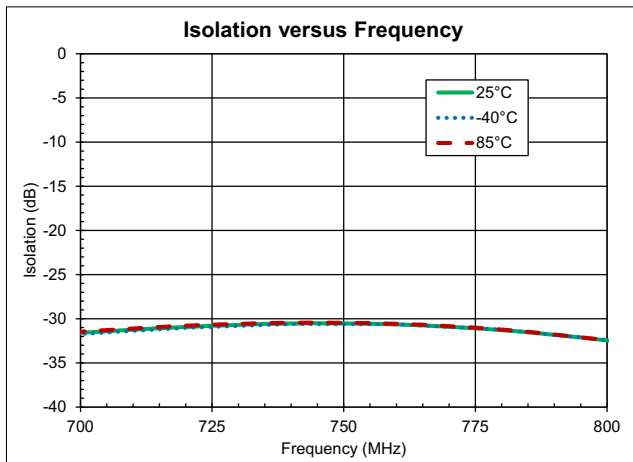
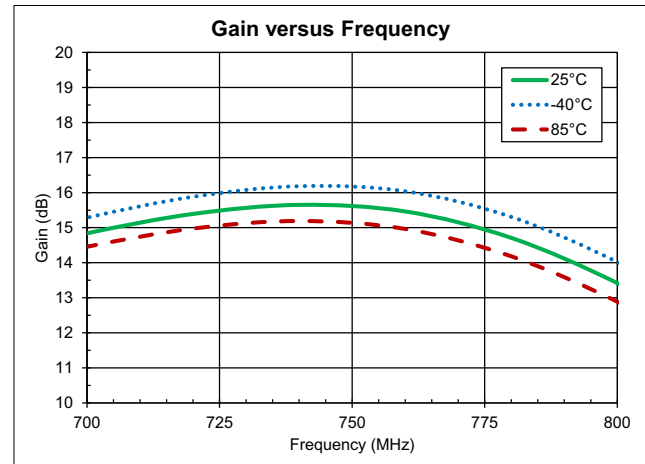
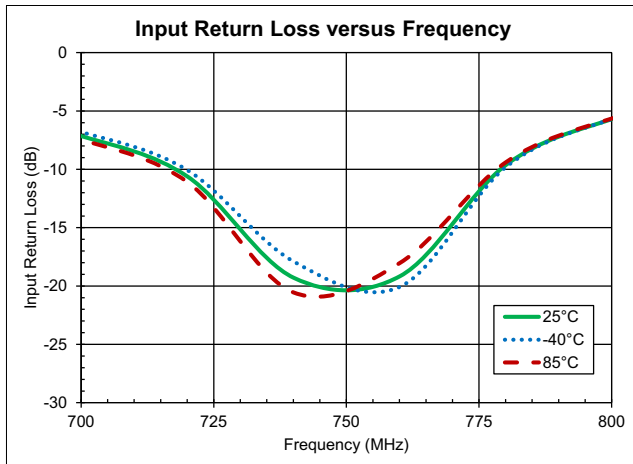

### Typical Performance

( $V_{CC}=V_{BIAS}=V_{REG}=5V$ , 728MHz to 768MHz Application Circuit)

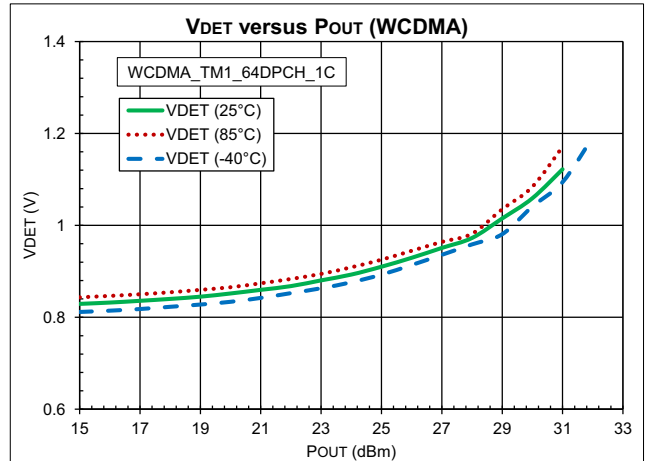
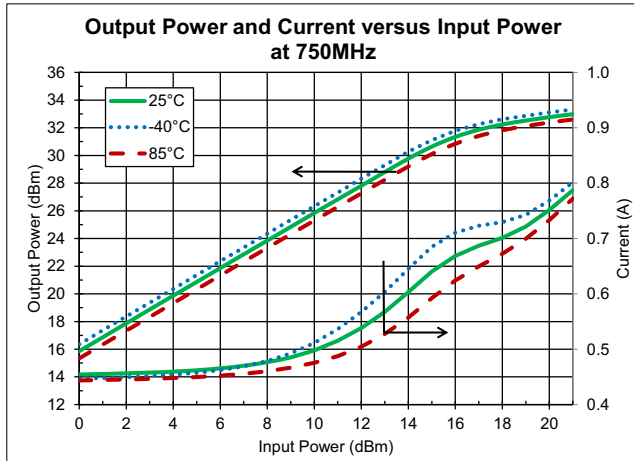
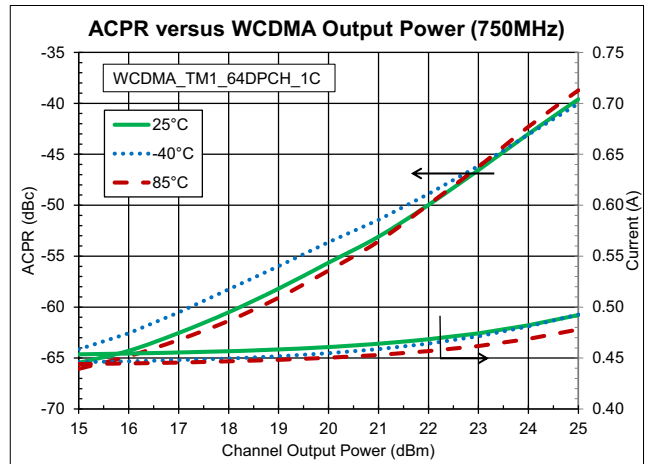
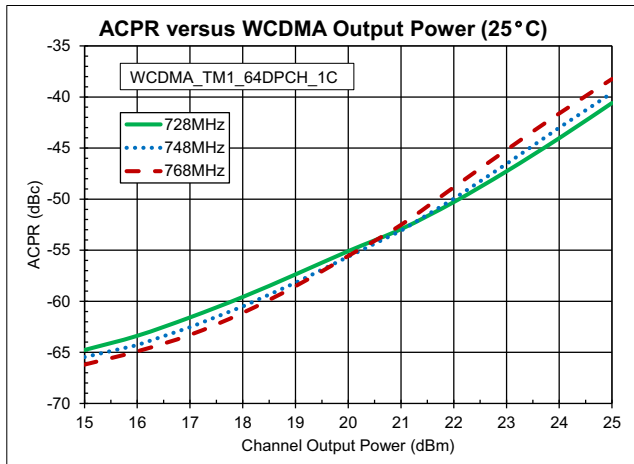

## Typical Performance

( $V_{CC}=V_{BIAS}=V_{REG}=5V$ , 728MHz to 768MHz Application Circuit)

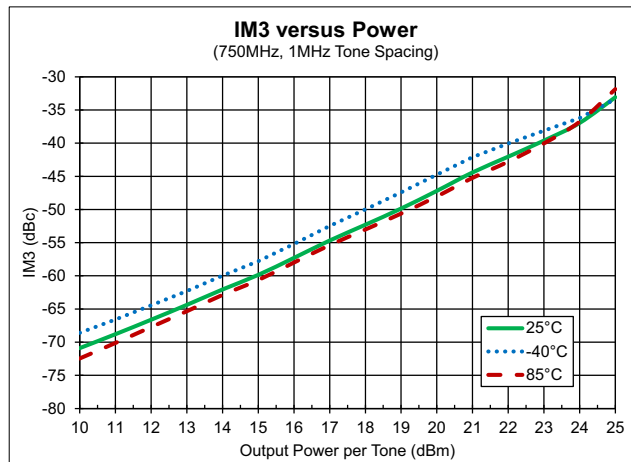
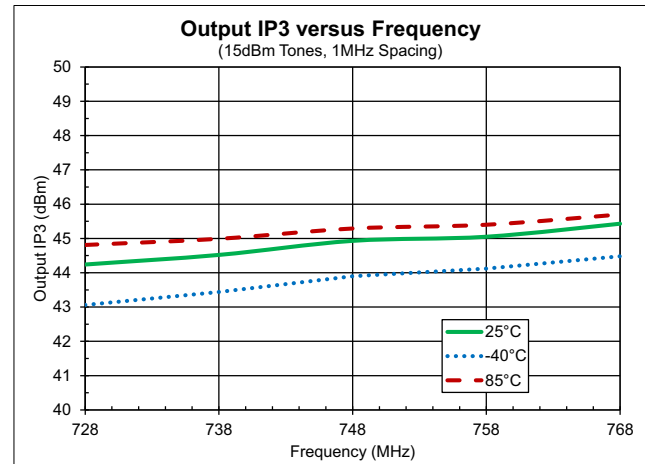
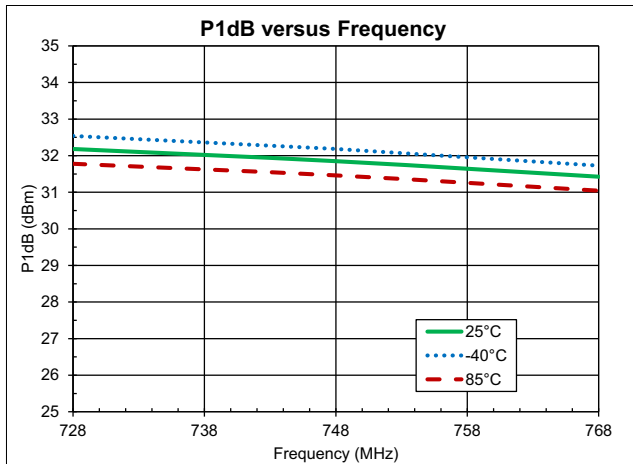

## Evaluation Board Schematic (728MHz to 768MHz Application Circuit)

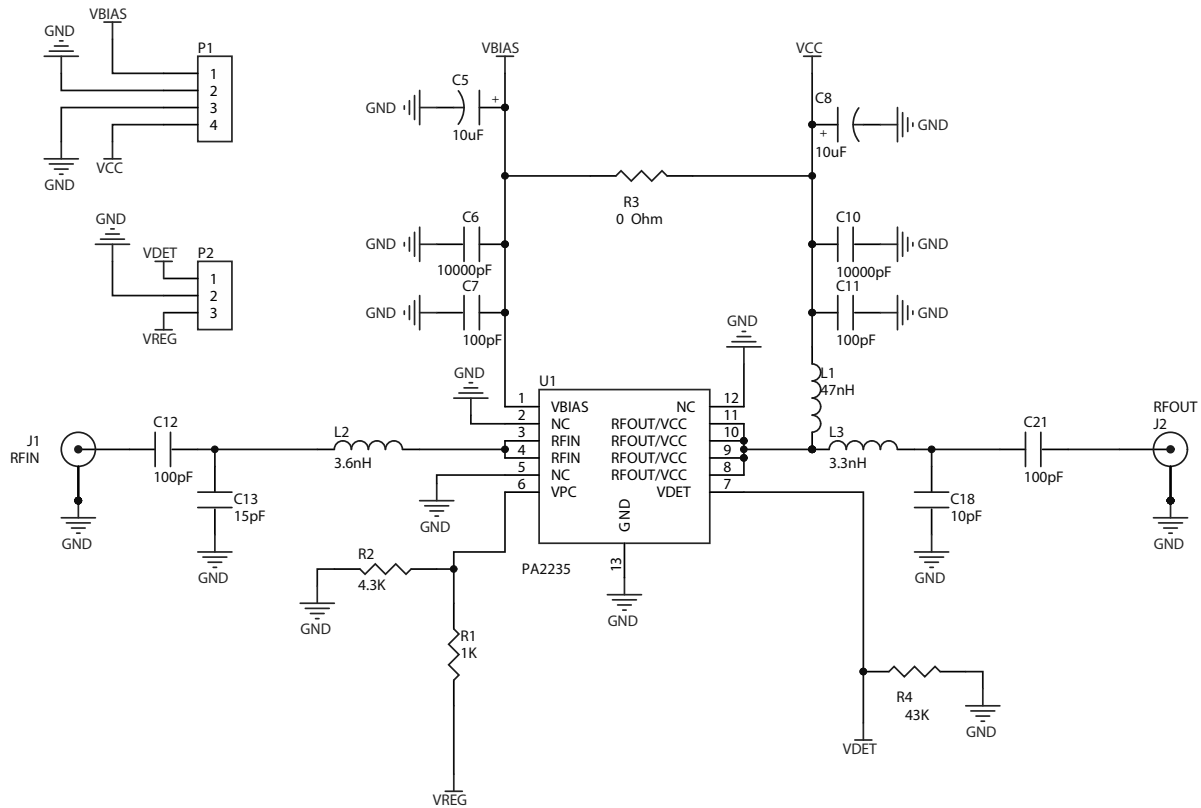

## Evaluation Board Build of Materials (BOM) (728MHz to 768MHz Application Circuit)

Description	Reference Designator	Manufacturer	Manufacturer's P/N
400-2700MHz, 2W, 5V High Gain Linear PA	U1	RFMD	PA2235
CAP, 10µF, 10%, 10V, TANT-A	C5, C8	AVX Corporation	TAJA106K010R
CAP, 10000pF, 10%, 16V, X7R, 0402	C6, C10	Taiyo Yuden (USA), Inc.	RM EMK105BJ103KV-F
CAP, 100pF, 5%, 50V, COG, 0402	C7, C11-C12, C21	Murata Electronics	GRM1555C1H101JA01D
CAP, 15pF, 2%, 50V, HI-Q, 0402	C13	Johanson Technology	500R07S150GV4TD
CAP, 10pF, 2%, 50V, HI-Q, 0402	C18	Johanson Technology	500R07S100GV4TD
CONN, SMA, END LNCH, RND PIN, 0.039"	J1-J2	Gigalane Co., Ltd.	PSF-S01-002
IND, 47nH, 5%, W/W, 0603	L1	Coilcraft, Inc.	0603HC-47NXJLW
IND, 3.6nH, 5%, W/W, 0402	L2	Coilcraft, Inc.	0402CS-3N6XJLW
IND, 3.3nH, 5%, W/W, 0402	L3	Coilcraft, Inc.	0402CS-3N3XJLY
CONN, HDR, ST, PLRZD, 4-PIN, 0.100"	P1	ITW Pancon	MPSS100-4-C
CONN, HDR, ST, PLRZD, 3-PIN, 0.100"	P2	ITW Pancon	MPSS100-3-C
RES, 1K, 5%, 1/16W, 0402	R1	Kamaya, Inc	RMC1/16S-102JTH
4.3KΩ, 5%, 1/16W, 0402, LEAD FREE	R2	KOA Speer Electronics, Inc.	RK73B1ETTP432J
RES, 0Ω, 0402	R3	Kamaya, Inc	RMC1/16SJPTH
RES, 43K, 5%, 1/16W, 0402	R4	Kamaya, Inc	RMC1/16S-433JTH

## Evaluation Board Assembly Drawing (728MHz to 768MHz Application Circuit)

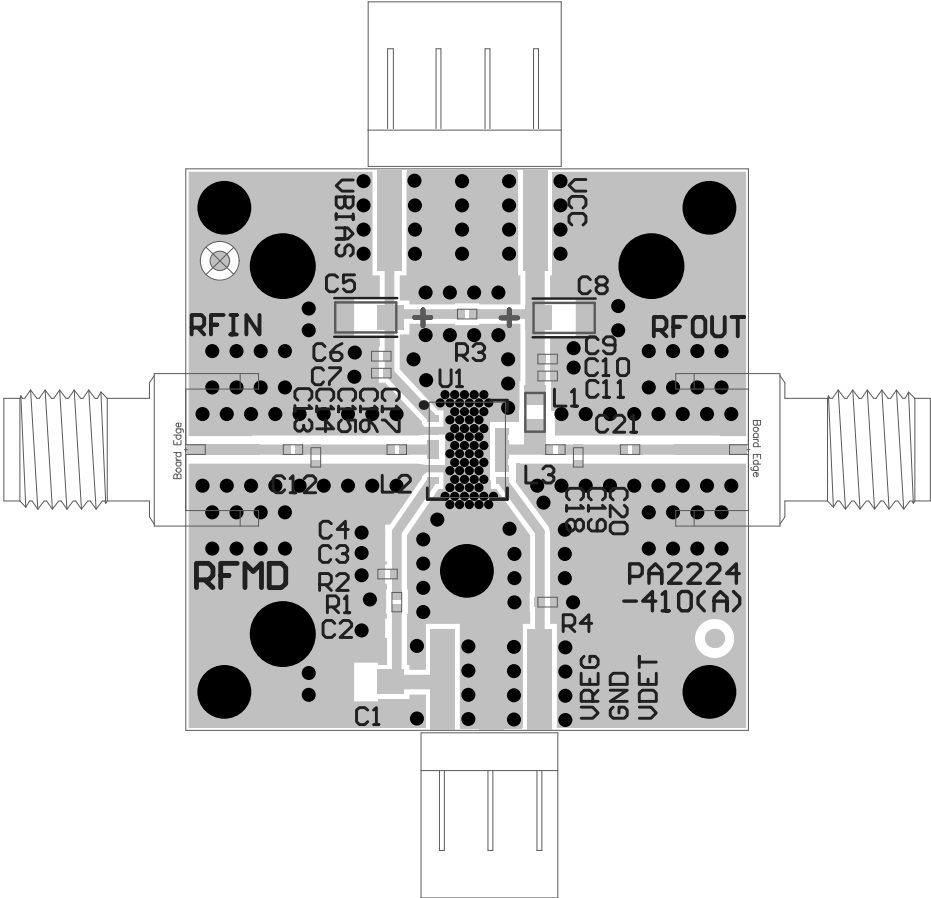



**Typical Performance**

( $V_{CC}=V_{BIAS}=V_{REG}=5V$ , 2.11GHz to 2.17GHz Application Circuit)

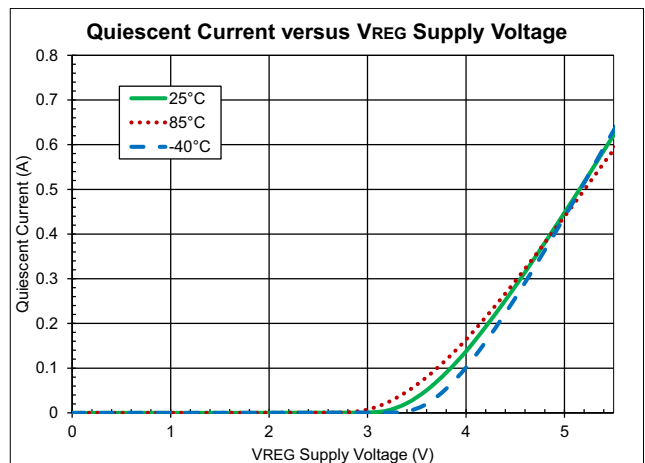
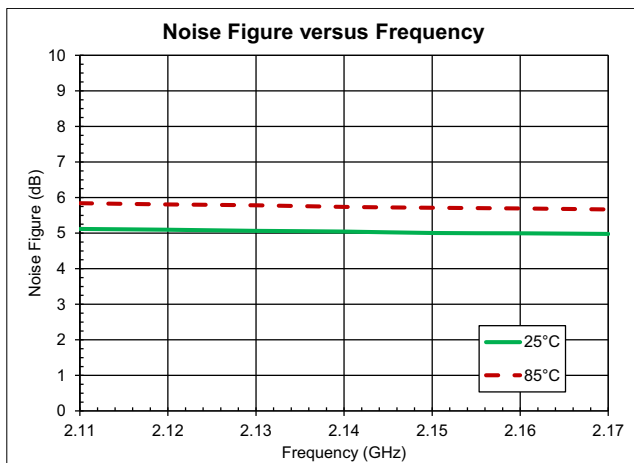
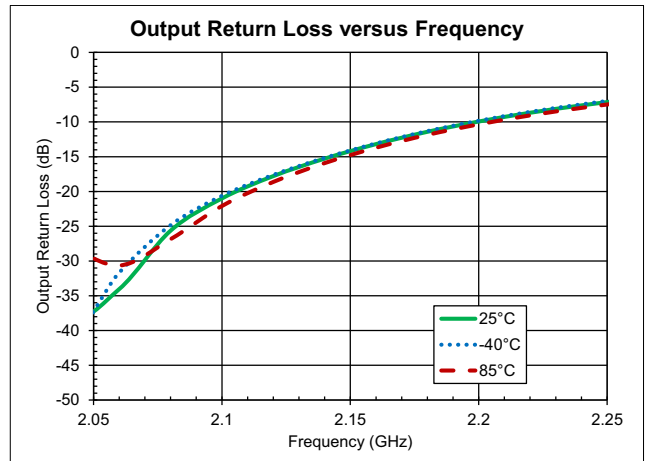
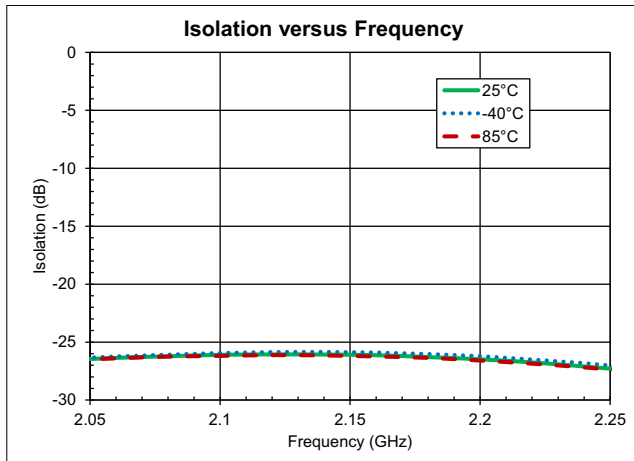
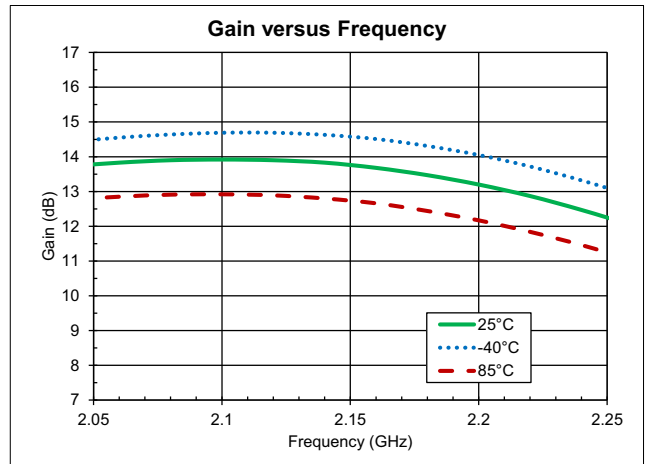
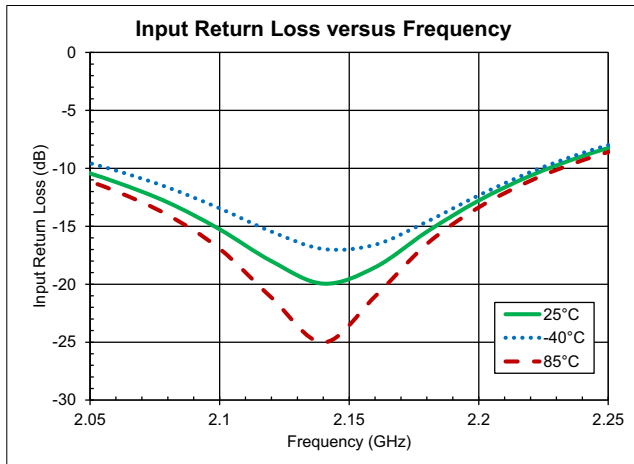

## Typical Performance

( $V_{CC}=V_{BIAS}=V_{REG}=5V$ , 2.11GHz to 2.17GHz Application Circuit)

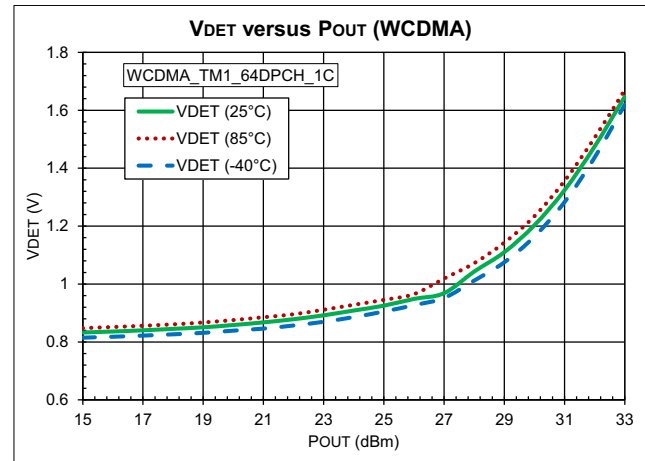
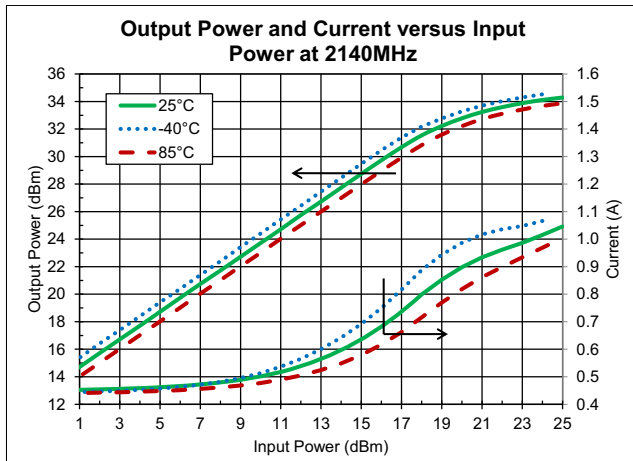
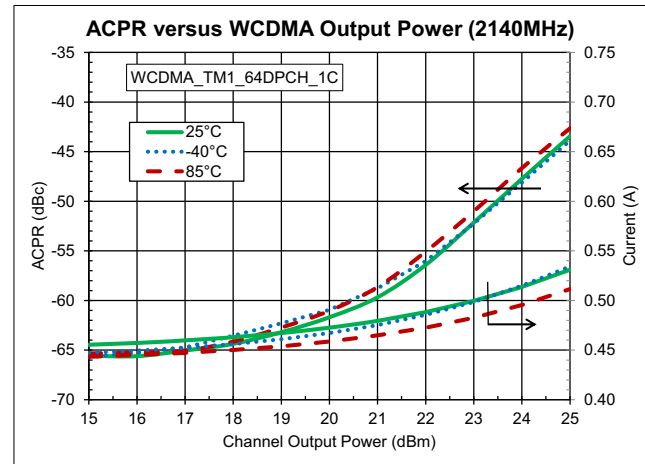
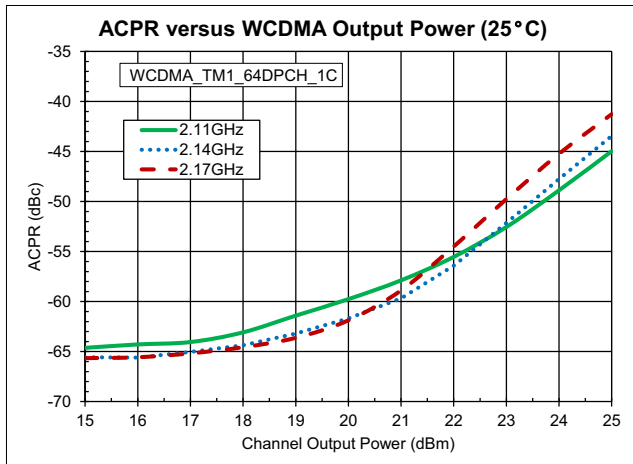

### Typical Performance

( $V_{CC}=V_{BIAS}=V_{REG}=5V$ , 2.11GHz to 2.17GHz Application Circuit)

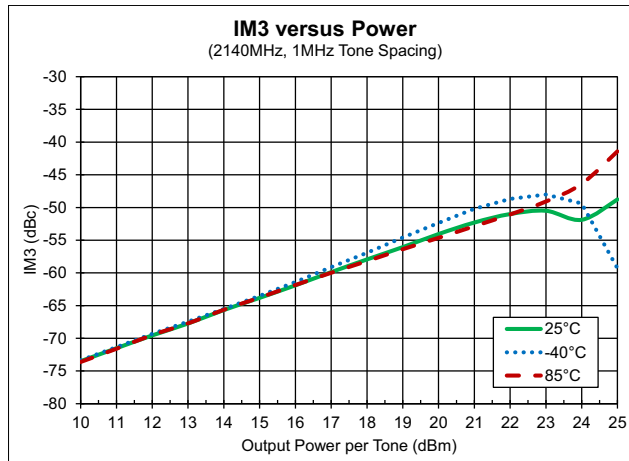
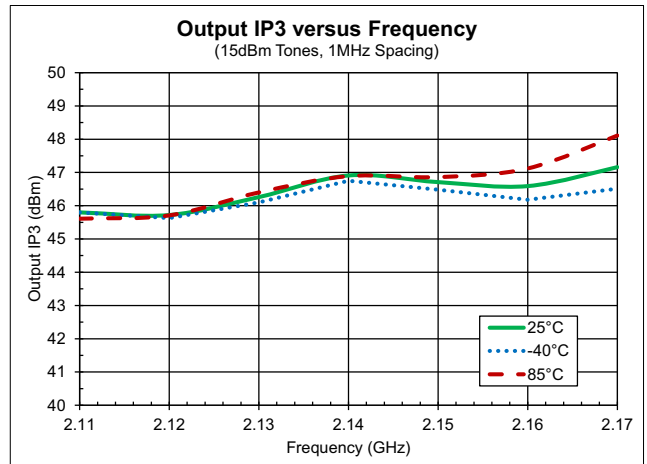
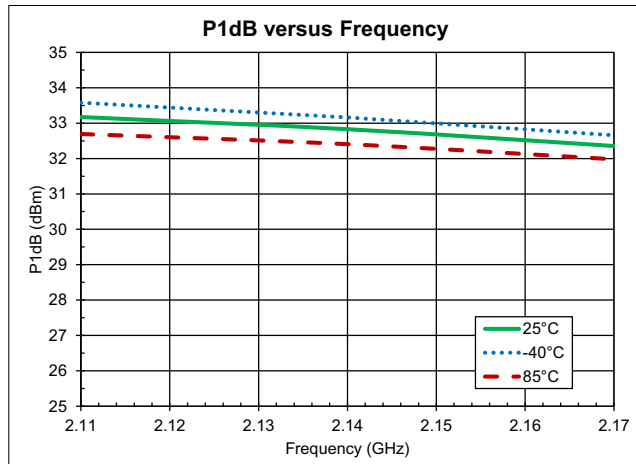

## Evaluation Board Schematic (2.11GHz to 2.17GHz Application Circuit)

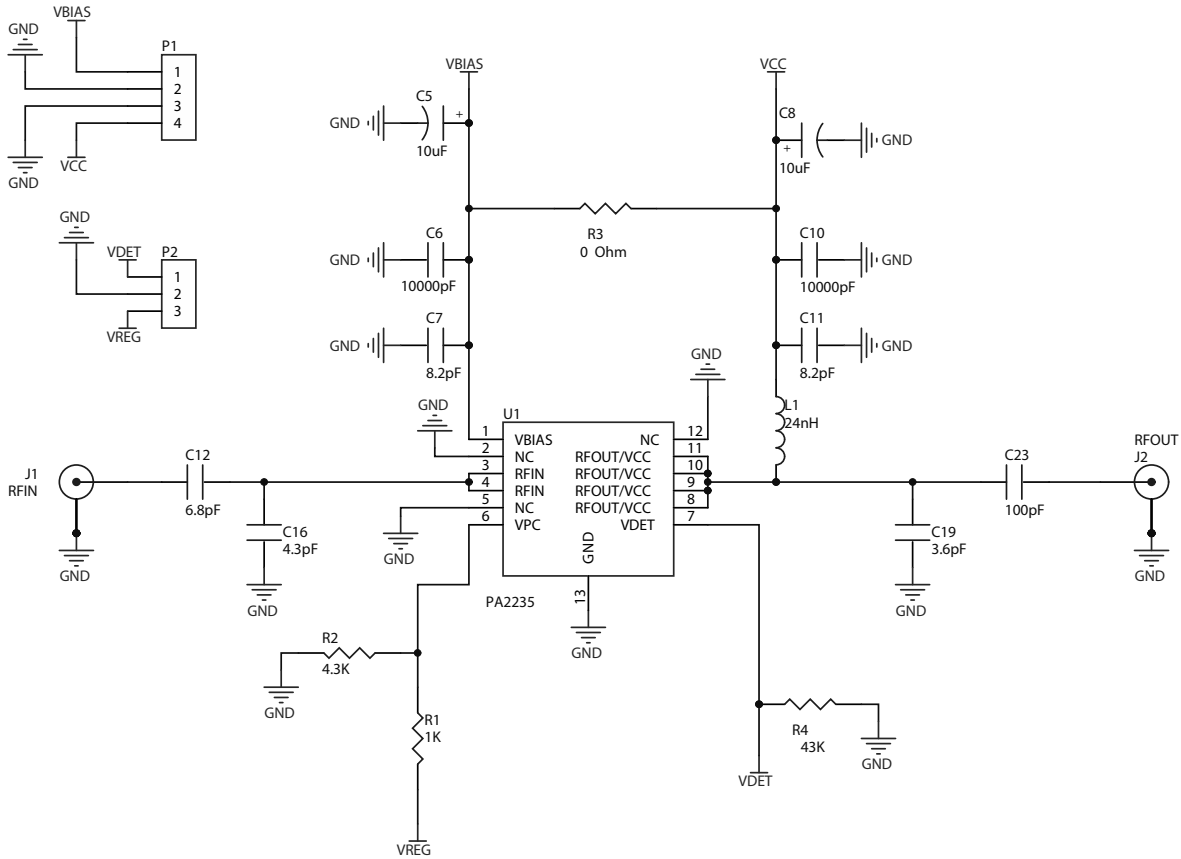

## Evaluation Board Build of Materials (BOM) (2.11GHz to 2.17GHz Application Circuit)

Description	Reference Designator	Manufacturer	Manufacturer's P/N
400-2700MHz, 2W, 5V High Gain Linear PA	U1	RFMD	PA2235
CAP, 10μF, 10%, 10V, TANT-A	C5, C8	AVX Corporation	TAJA106K010R
CAP, 10000pF, 10%, 16V, X7R, 0402	C6, C10	Taiyo Yuden (USA), Inc.	RM EMK105BJ103KV-F
CAP, 8.2pF, +/-0.5pF, 50V, COG, 0402	C7, C11	Taiyo Yuden (USA), Inc.	RM UMK105 CG8R2DV-F
CAP, 6.8pF, +/-0.1pF, 50V, HI-Q, 0402	C12	Johanson Technology	500R07S6R8BV4TD
CAP, 4.3pF, +/-0.1pF, 50V, HI-Q, 0402	C16	Johanson Technology	500R07S4R3BV4TD
CAP, 3.6pF, +/-0.1pF, 50V, HI-Q, 0402	C19	Johanson Technology	500R07S3R6BV4TD
CAP, 100pF, 5%, 50V, COG, 0402	C23	Murata Electronics	GRM1555C1H101JA01D
CONN, SMA, END LNCH, RND PIN, 0.039"	J1-J2	Gigalane Co., Ltd.	PSF-S01-002
IND, 24nH, 5%, W/W, 0603	L1	Coilcraft, Inc.	0603HC-24NXJLW
CONN, HDR, ST, PLRZD, 4-PIN, 0.100"	P1	ITW Pancon	MPSS100-4-C
CONN, HDR, ST, PLRZD, 3-PIN, 0.100"	P2	ITW Pancon	MPSS100-3-C
RES, 1K, 5%, 1/16W, 0402	R1	Kamaya, Inc	RMC1/16S-102JTH
4.3KΩ, 5%, 1/16W, 0402, LEAD FREE	R2	KOA Speer Electronics, Inc.	RK73B1ETTP432J
RES, 0Ω, 0402	R3	Kamaya, Inc	RMC1/16SJPTH
RES, 43K, 5%, 1/16W, 0402	R4	Kamaya, Inc	RMC1/16S-433JTH

**Evaluation Board Assembly Drawing**  
(2.11GHz to 2.17GHz Application Circuit)

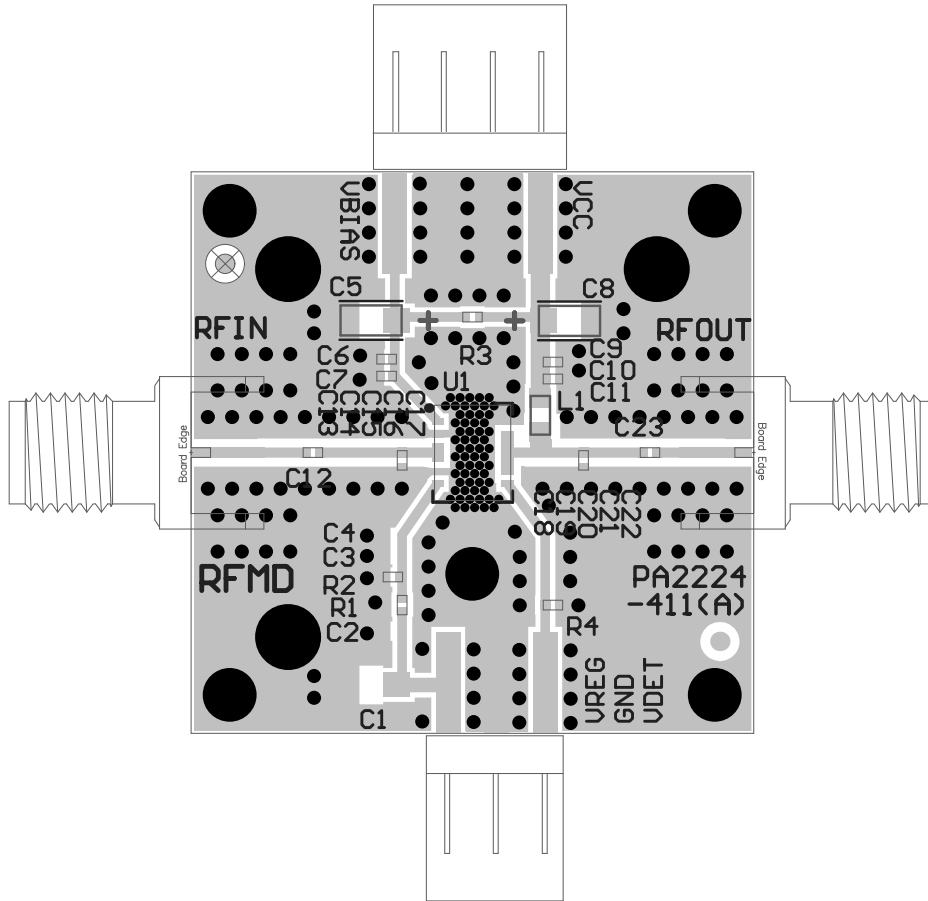

## Typical Performance

( $V_{CC}=V_{BIAS}=V_{REG}=5V$ , 2.58GHz to 2.69GHz Application Circuit)

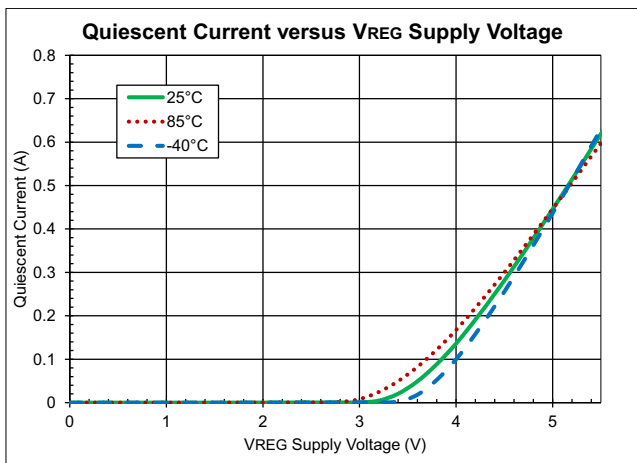
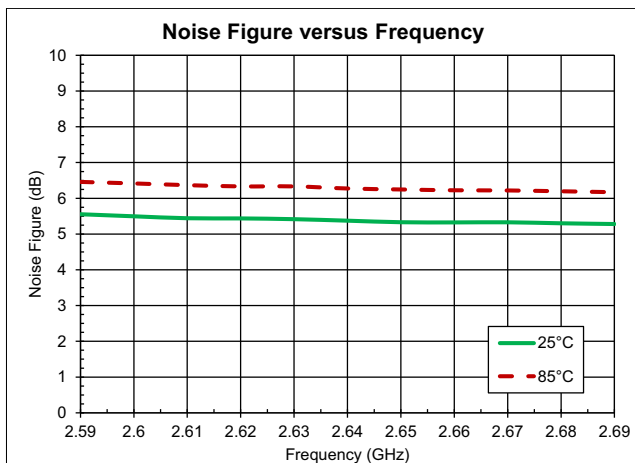
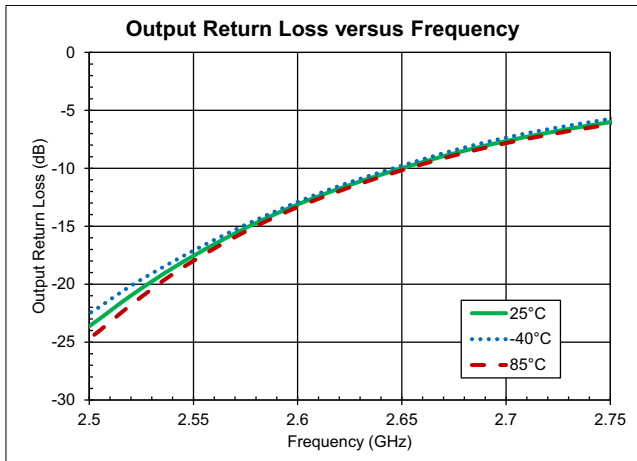
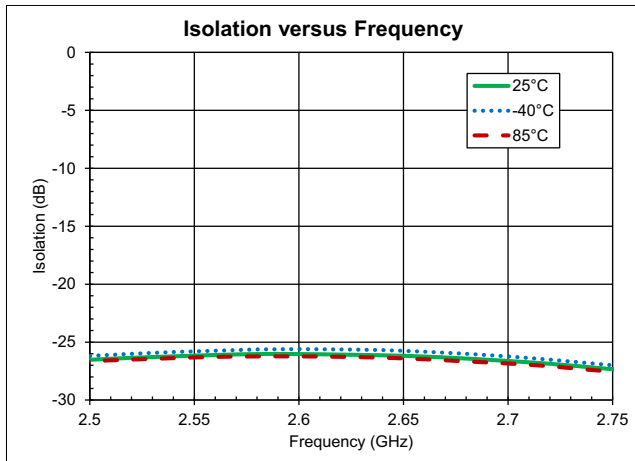
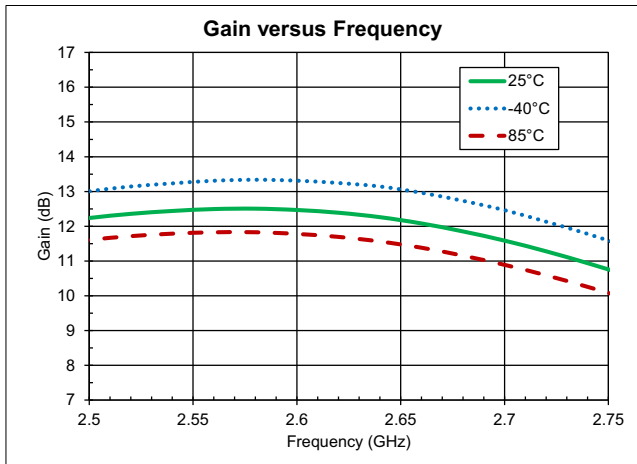
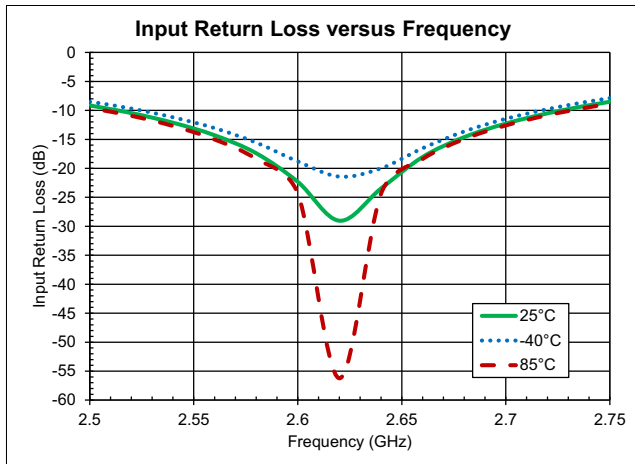

### Typical Performance

( $V_{CC}=V_{BIAS}=V_{REG}=5V$ , 2.58GHz to 2.69GHz Application Circuit)

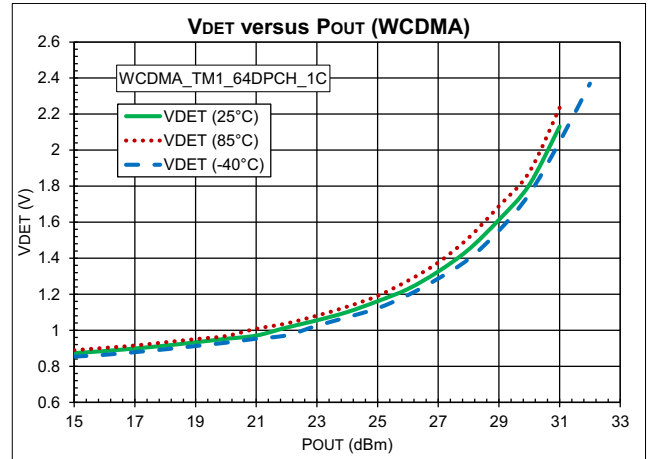
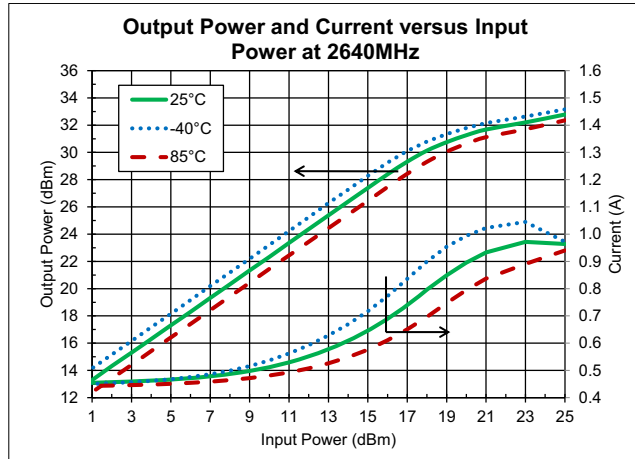
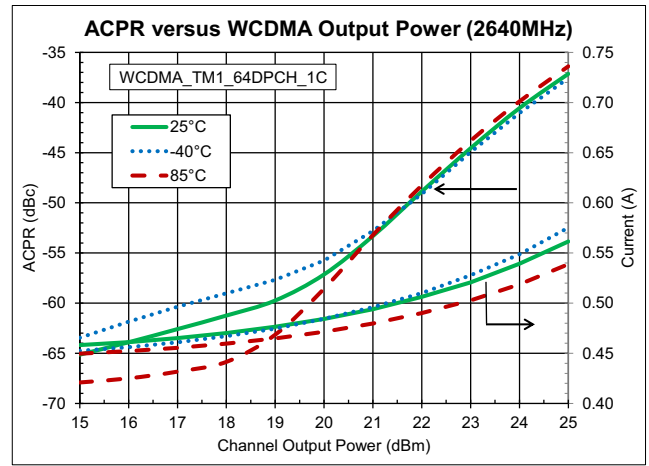
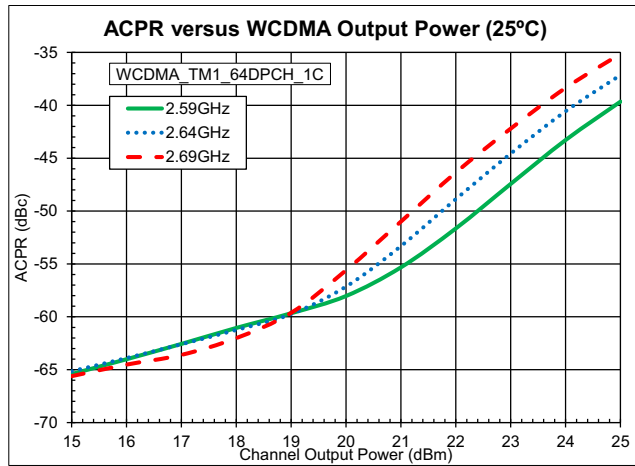

## Typical Performance

( $V_{CC}=V_{BIAS}=V_{REG}=5V$ , 2.58GHz to 2.69GHz Application Circuit)

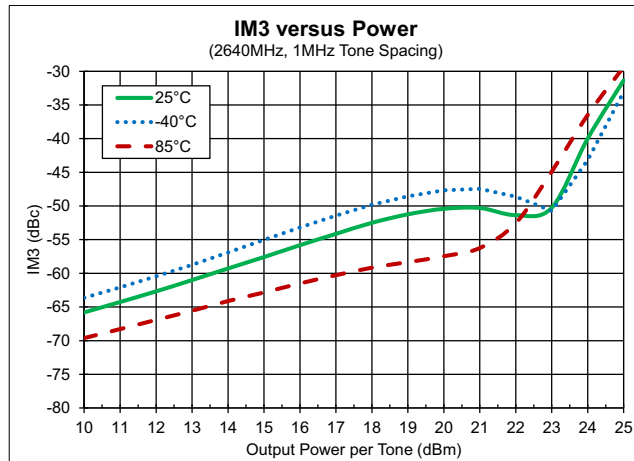
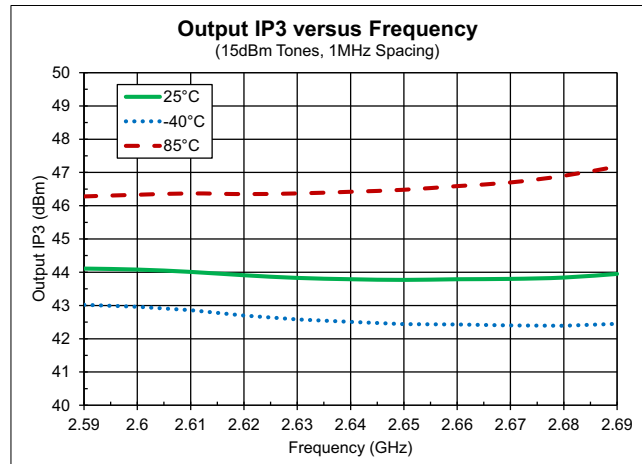
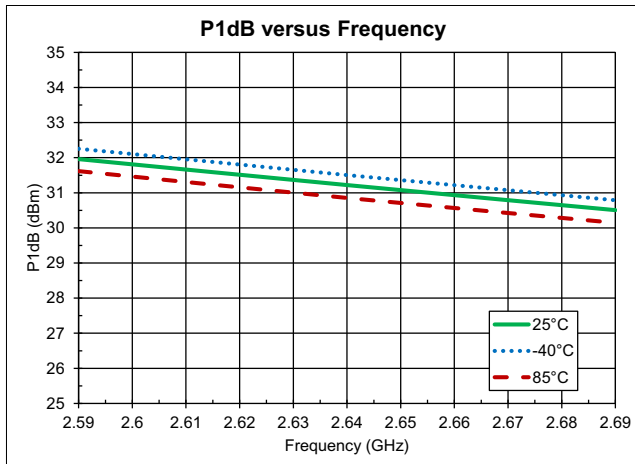



## Evaluation Board Schematic (2.58GHz to 2.69GHz Application Circuit)

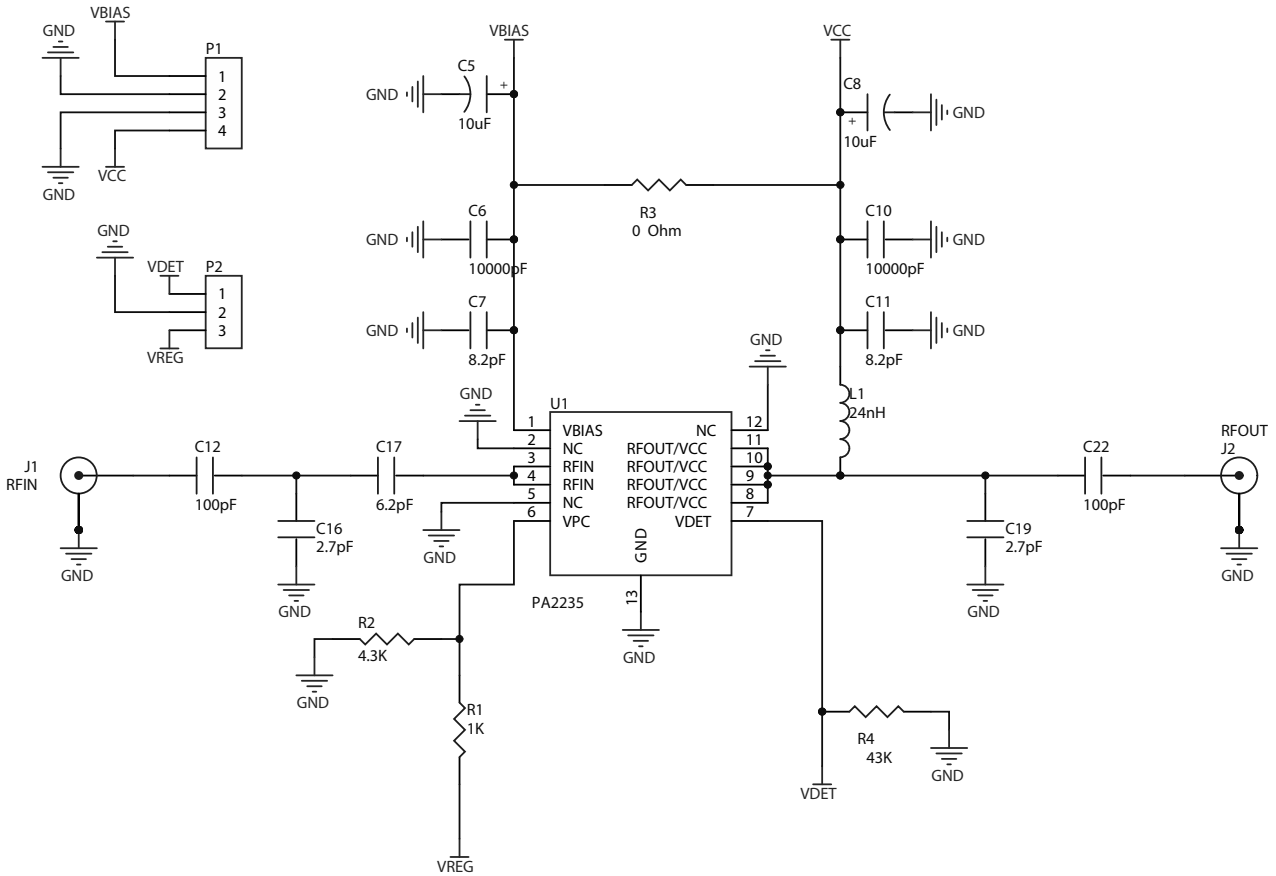

## Evaluation Board Build of Materials (BOM) (2.58GHz to 2.69GHz Application Circuit)

Description	Reference Designator	Manufacturer	Manufacturer's P/N
400-2700MHz, 2W, 5V High Gain Linear PA	U1	RFMD	PA2235
CAP, 10µF, 10%, 10V, TANT-A	C5, C8	AVX Corporation	TAJA106K010R
CAP, 10000pF, 10%, 16V, X7R, 0402	C6, C10	Taiyo Yuden (USA), Inc.	RM EMK105BJ103KV-F
CAP, 8.2pF, +/-0.5pF, 50V, COG, 0402	C7, C11	Taiyo Yuden (USA), Inc.	RM UMK105 CG8R2DV-F
CAP, 100pF, 5%, 50V, COG, 0402	C12, C22	Murata Electronics	GRM1555C1H101JA01D
CAP, 2.7pF, +/-0.1pF, 50V, HI-Q, 0402	C16, C19	Johanson Technology	500R07S2R7BV4TD
CAP, 6.2pF, +/-0.1pF, 50V, HI-Q, 0402	C17	Johanson Technology	500R07S6R2BV4TD
CONN, SMA, END LNCH, RND PIN, 0.039"	J1-J2	Gigalane Co., Ltd.	PSF-S01-002
IND, 24nH, 5%, W/W, 0603	L1	Coilcraft, Inc.	0603HC-24NXJLW
CONN, HDR, ST, PLRZD, 4-PIN, 0.100"	P1	ITW Pancon	MPSS100-4-C
CONN, HDR, ST, PLRZD, 3-PIN, 0.100"	P2	ITW Pancon	MPSS100-3-C
RES, 1K, 5%, 1/16W, 0402	R1	Kamaya, Inc	RMC1/16S-102JTH
4.3KΩ, 5%, 1/16W, 0402, LEAD FREE	R2	KOA Speer Electronics, Inc.	RK73B1ETTP432J
RES, 0Ω, 0402	R3	Kamaya, Inc	RMC1/16SJPTH
RES, 43K, 5%, 1/16W, 0402	R4	Kamaya, Inc	RMC1/16S-433JTH

## Evaluation Board Assembly Drawing (2.58GHz to 2.69GHz Application Circuit)

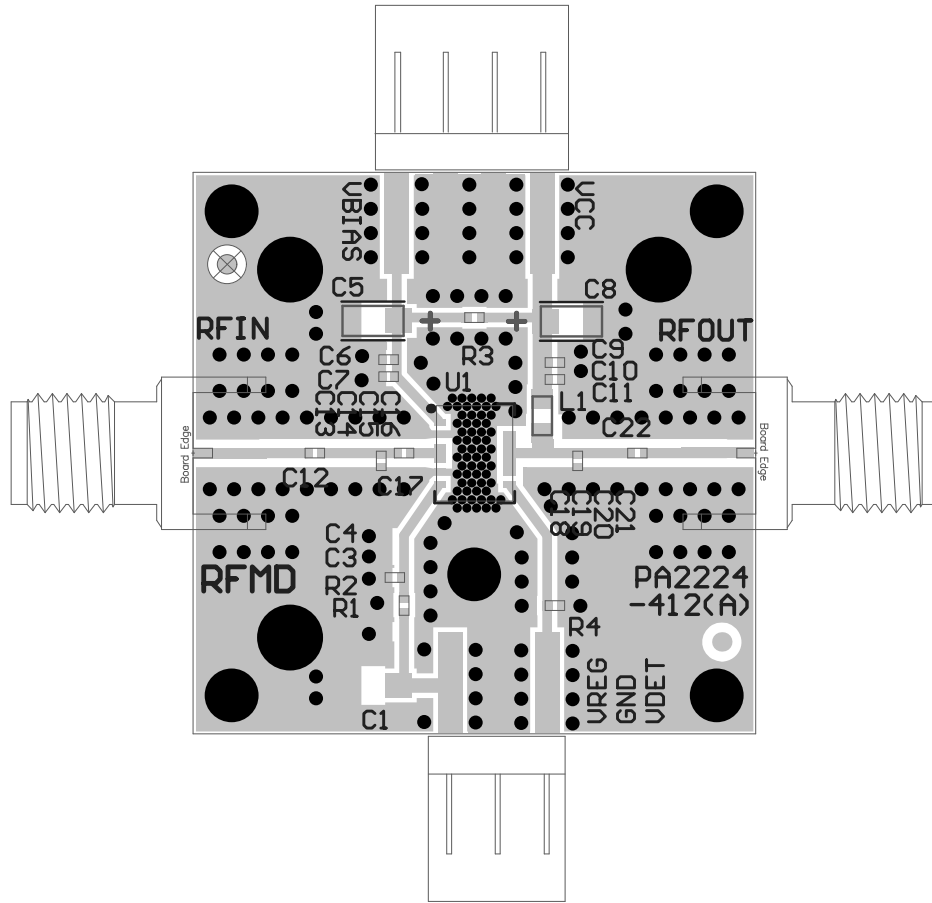

### Pin Description Table

Pin	Name	Description
<b>1</b>	<b>VBIAS</b>	V <sub>CC</sub> Supply to Active Bias Circuit
<b>2</b>	<b>NC</b>	No internal connection
<b>3</b>	<b>RFIN</b>	RF input, must be DC blocked
<b>4</b>	<b>RFIN</b>	RF input, must be DC blocked
<b>5</b>	<b>NC</b>	No internal connection
<b>6</b>	<b>VREG</b>	Current Adjust / Shutdown control
<b>7</b>	<b>VDET</b>	Power detector output voltage. Detector samples the input power.
<b>8</b>	<b>RFOUT/VCC</b>	RF output and collector supply
<b>9</b>	<b>RFOUT/VCC</b>	RF output and collector supply
<b>10</b>	<b>RFOUT/VCC</b>	RF output and collector supply
<b>11</b>	<b>RFOUT/VCC</b>	RF output and collector supply
<b>12</b>	<b>NC</b>	No internal connection
<b>EPAD</b>	<b>GND</b>	DC & RF Ground. Must be soldered to EVB ground plane over a bed of vias for thermal and RF performance. Solder/epoxy voids under the EPAD will result in excessive junction temperatures causing permanent damage.

## Package and Branding Diagram

Dimensions in millimeters

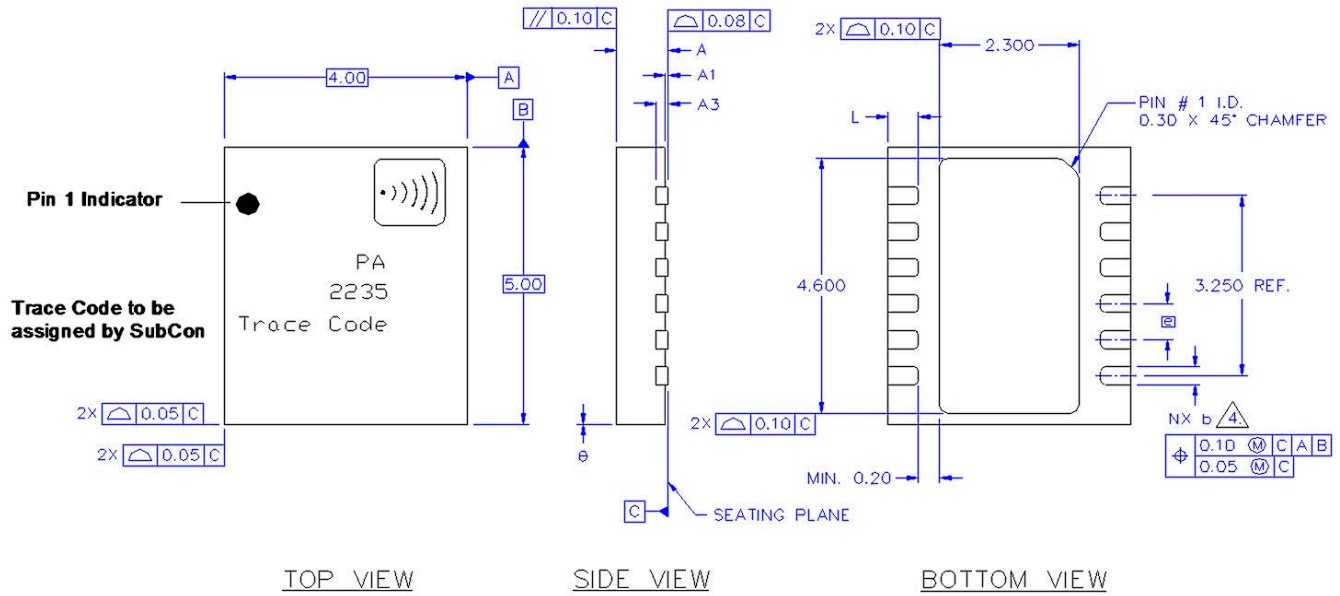

SYMBOL	COMMON DIMENSIONS		
	MIN.	NOM.	MAX.
A	0.80	0.85	0.90
A1	0.00	0.02	0.05
A3	0.20 REF.		
θ	0	-	12°
e	0.65 BSC		
N	12		
L	0.45	0.50	0.55
b	0.275	0.325	0.375

Note: Refer to drawing posted at [www.rfmd.com](http://www.rfmd.com) for tolerances.