

Differential Positive ECL (DPECL) HS-2870 Series

Description

The **HS-2870 Series** of quartz crystal oscillators provide MECL 10K and 10KH series compatible signals in industry standard four-pin DIP hermetic packages. Systems designers may now specify space-saving, cost-effective packaged PECL oscillators to meet their timing requirements. This device is intended to operate on positive voltage for PECL applications.

Features

- Wide frequency range—15.0MHz to 250.0MHz
- User specified tolerance available
- Will withstand vapor phase temperatures of 253°C for 4 minutes maximum
- Space-saving alternative to discrete component oscillators
- High shock resistance, to 3000g
- All metal, resistance weld, hermetically sealed package
- Low Jitter
- MECL 10K and 10KH series compatible output on Pin 8, complement on Pin 1
- High Q Crystal actively tuned oscillator circuit
- Power supply decoupling internal
- No internal PLL avoids cascading PLL problems
- High frequencies due to proprietary design
- Gold plated leads - Solder dipped leads available upon request

Electrical Connection

Pin	Connection
1	Output Complement
7	V _{EE} /Ground
8	Output
14	V _{CC} +5.0V

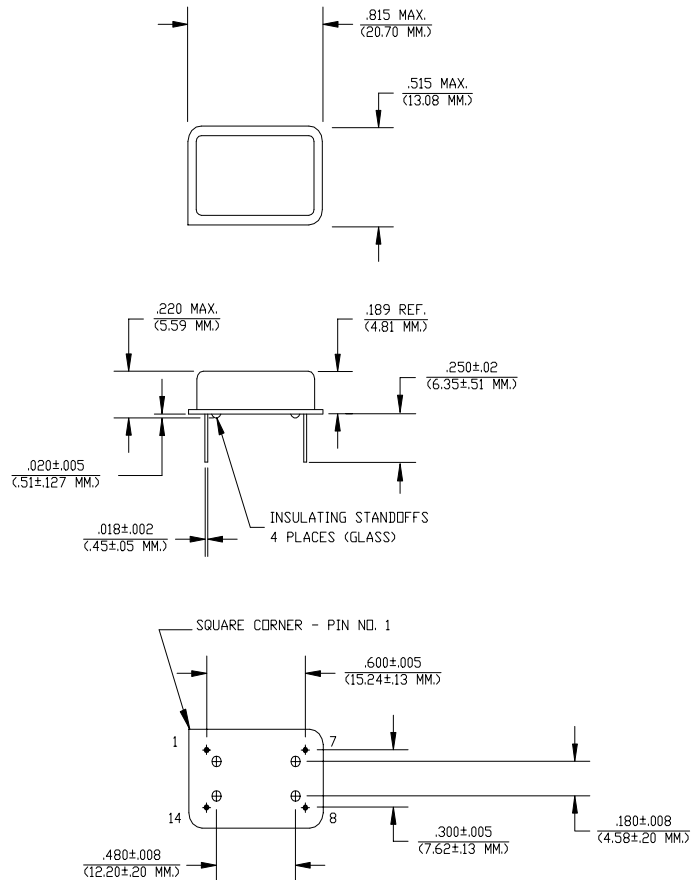

Dimensions are in inches and (MM)

HS-2870 Series Continued Differential Positive ECL (DPECL)

Operating Conditions and Output Characteristics

Electrical Characteristics

Parameter	Symbol	Conditions	Min	Typical	Max
Frequency	----	----	15.0MHz	----	250.0MHz
Duty Cycle	----	@V _{CC} -1.29V	45/55%	----	55/45%
Logic 0 ⁽²⁾	V _{OL}	----	V _{CC} -1.95V	----	V _{CC} -1.60V
Logic 1 ⁽²⁾	V _{OH}	----	V _{CC} -1.02V	----	V _{CC} -0.74V
Rise & Fall Time	tr,tf	20-80%V _O with 50 ohm load to V _{CC} -2V	----	1.0 ns	1.5 ns
Tpd ⁽⁴⁾	----	----	-0.5 ns	----	+0.5 ns
Jitter, RMS ⁽³⁾	----	----	----	----	5 psec
Frequency Stability ⁽¹⁾	dF/F	Overall conditions including: voltage, calibration, temp., 10 yr aging, shock, vibration	-100ppm	----	+100ppm

General Characteristics

Parameter	Symbol	Conditions	Min	Typical	Max
Supply Voltage	V _{CC}	----	4.75V	5.0V	5.25V
Supply Current	I _{CC}	50 ohm termination To 2.00V below V _{CC}	0.0 mA	----	80 mA
Output current	I _O	Low level Output Current	0.0 mA	----	±50.0 mA
Operating temperature	T _A	----	0°C	----	70°C
Storage temperature	T _S	----	-55°C	----	125°C
Power Dissipation	P _D	----	----	----	420 mW
Lead temperature	T _L	Soldering, 10 sec.	----	----	300°C
Load		50 Ohm to V _{CC} -2V or Thevenin Equivalent, Bias Required			
Start-up time	t _s	----	----	2 ms	10 ms

Environmental and Mechanical Characteristics

Mechanical Shock	Per MIL-STD-202, Method 213, Condition E
Thermal Shock	Per MIL-STD-883, Method 1011, Condition A
Vibration	0.060" double amplitude 10 Hz to 55 Hz, 35g's 55Hz to 2000 Hz
Soldering Condition	300°C for 10 seconds
Hermetic Seal	Leak rate less than 1 x 10 ⁻⁸ atm.cc/sec of helium
ESD Sensitivity	Human Body Model per ON Semiconductor 10kH series ECL: 500V min.

Footnotes:

- 1) Standard frequency stability (±20,±25,±50ppm & others available)
- 2) V_{OL}, V_{OH}, referenced to ground (V_{EE}) with V_{CC} = 5V
- 3) Jitter performance is frequency dependent. Please contact factory for full characterization.
- 4) Tpd is phase shift between the falling edge of pin 8 at V_{CC}-1.29V and rising edge of pin 1 at V_{CC}-1.29V.

Creating a Part Number	
HS - A287X - FREQ	
Package Code	Tolerance/Performance
HS Leaded 4 pin (14 pin)	0 ±100ppm 0-70°C
SM Leaded 4 pin (14 pin) SMD	1 ±50ppm 0-70°C
Gull Wing	7 ±25ppm 0-70°C
Input Voltage	9 Customer Specific
Code Specification	A ±20ppm 0-70°C
A 3.3V	B ±50ppm -40 to +85°C
5V	C ±100ppm -40 to +85°C

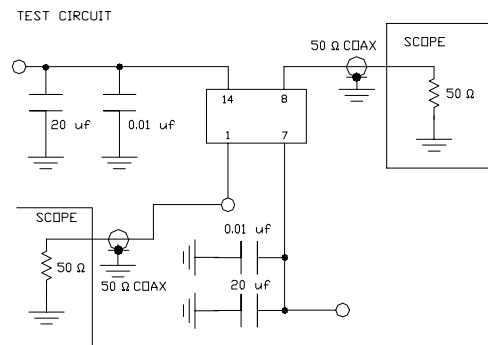

TEST CIRCUIT USES A SPLIT SUPPLY OF +2V AND -3V FOR EASE OF TESTING.