

1F1 thru 1F7

1 Feature & Dimensions

- * Plastic package has Underwriters Laboratory Flammability Classification 94V-0
- * High temperature metallurgically bonded construction
- * Diffused junction
- * Capable of meeting environmental standards of MIL-S-19500
- * 1.0 A operation at TA=55°C with no thermal runaway
- * For use in high frequency rectifier circuits
- * Fast switching for high efficiency
- * Typical IR less than 1.0µA
- * High temperature soldering guaranteed: 350°C/10 seconds
- * 0.375" (9.5mm) lead length, 5 lbs. (2.3kg) tension

2 Mechanical Data

- Case:** JEDEC R-1, molded plastic body
Terminals: Plated axial leads, solderable per MIL-STD-750, Method 2026
Polarity: Color band denotes cathode end
Mounting Position: Any
Weight: 0.007 oz., 0.20 g
Handling precaution: None

3 Electrical Characteristic

Maximum Ratings & Thermal Characteristics Ratings at 25°C ambient temperature unless otherwise specified.

Parameter Symbol	symbol	1F1	1F2	1F3	1F4	1F5	1F6	1F7	Unit
Maximum repetitive peak reverse voltage	V _{RRM}	50	100	200	400	600	800	1000	V
Maximum RMS voltage	V _{RMS}	35	70	140	280	420	560	700	V
Maximum DC blocking voltage	V _{DC}	50	100	200	400	600	800	1000	V
Maximum average forward rectified current 0.375" (9.5mm) lead length at T _A = 55°C	I _{F(AV)}	1.0							A
Peak forward surge current 8.3ms single half sine-wave superimposed on rated load (JEDEC Method)	I _{FSM}	25							A
Maximum full load reverse current, full cycle average, 0.375" (9.5mm) lead lengths at T _A = 55°C	I _{R(AV)}	100							µA
Typical thermal resistance (Note 2)	R _{θJA}	55							°C/W
Operating junction and storage temperature range	T _J , T _{STG}	-50to +150							°C

Electrical Characteristics Ratings at 25°C ambient temperature unless otherwise specified.

Parameter Symbol	symbol	1F1	1F2	1F3	1F4	1F5	1F6	1F7	Unit
Maximum instantaneous forward voltage at 1.0A	V _F	1.3							V
Maximum DC reverse current TA = 25°C at rated DC blocking voltage TA = 100°C	I _R	5.0 200							µA
Typical reverse recovery time (Note 1)	t _{rr}	150			250		500		ns
Typical junction capacitance at 4.0V, 1MHz	C _J	15							PF

NOTES:

1. I_F = 0.5A, I_R = 1.0A, I_{RR} = 0.25A
2. Thermal resistance from junction to ambient at 0.375" (9.5mm) lead length, P.C.B. mounted

Fast Recovery Rectifiers

Reverse Voltage 50 to 1000V
 Forward Current 1.0A

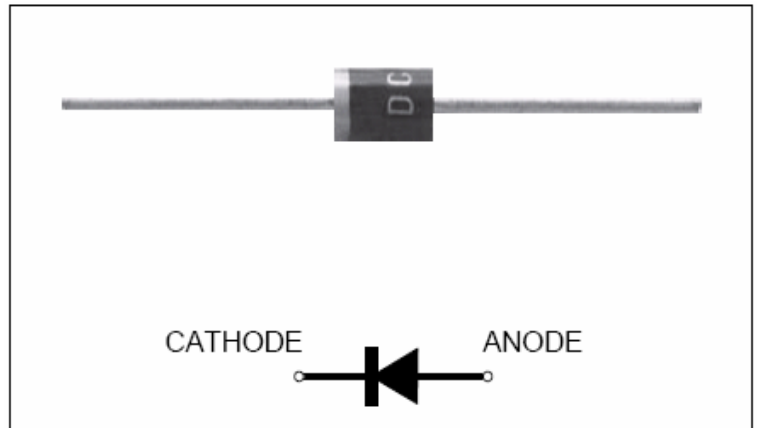

We declare that the material of product compliance with RoHS requirements.

4. Characteristic Curves (TA = 25°C unless otherwise noted)

Fig. 1 - Forward Current Derating Curve

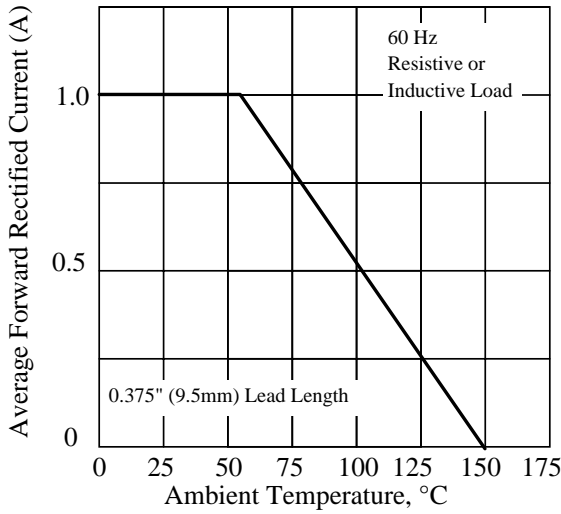

Fig. 2 - Maximum Non-repetitive Peak Forward Surge Current

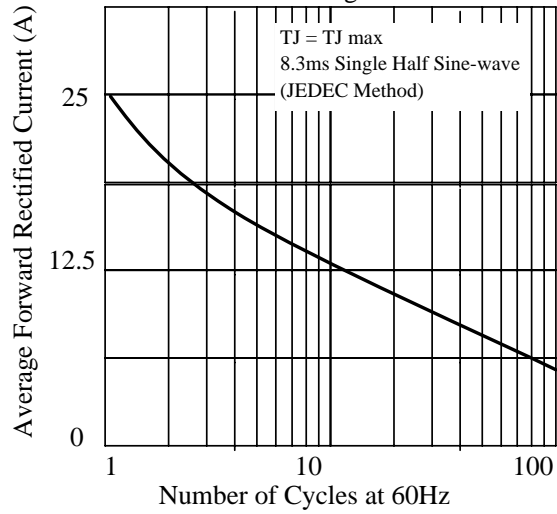

Fig 3. - Typical Instantaneous Forward Characteristics

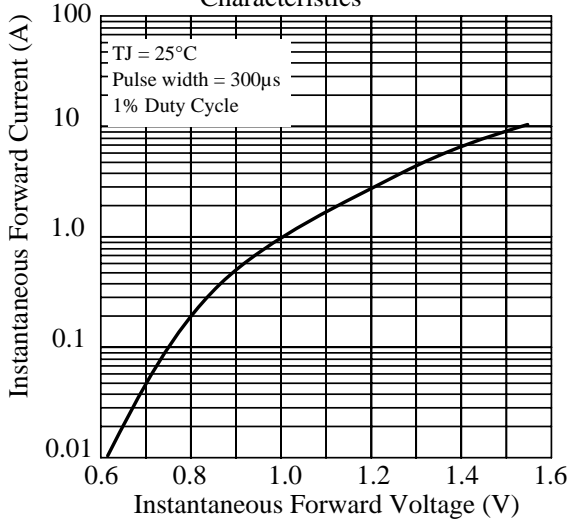

Fig 4. - Typical Reverse Characteristics

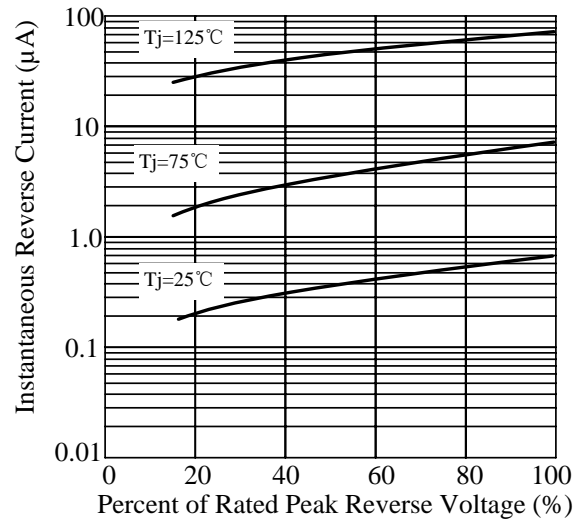

Fig 5. - typical transient thermal impedance

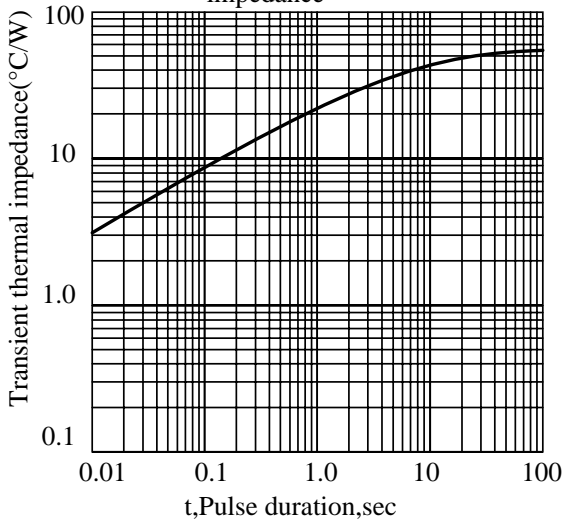
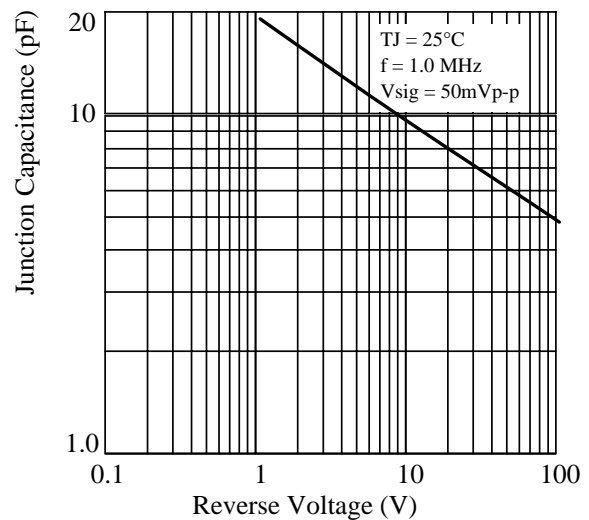
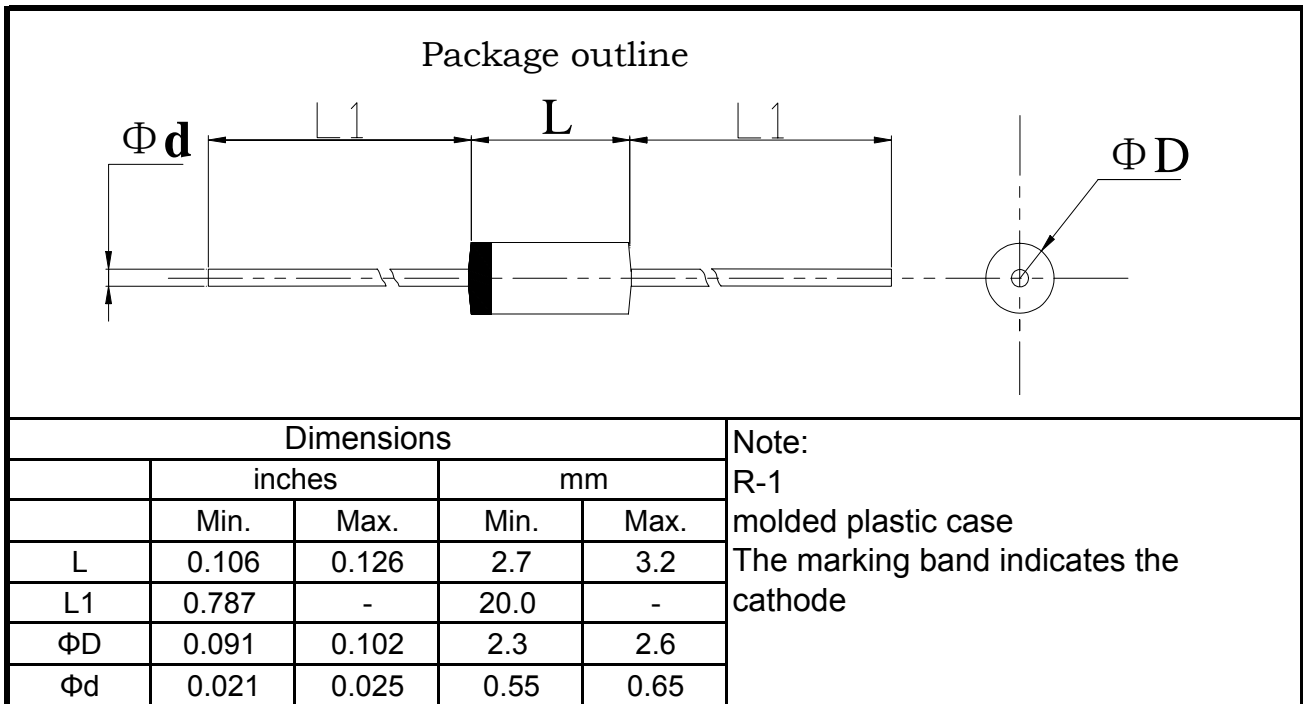

Fig 6. - Typical Junction Capacitance



5.Package Dimensions in inches and (millimeters)

Packing Of Plastic-Sealed Axial Lead Diodes

1. 卷盘/Reel Packing (52mm)

A: 卷盘规格/Reel spec.

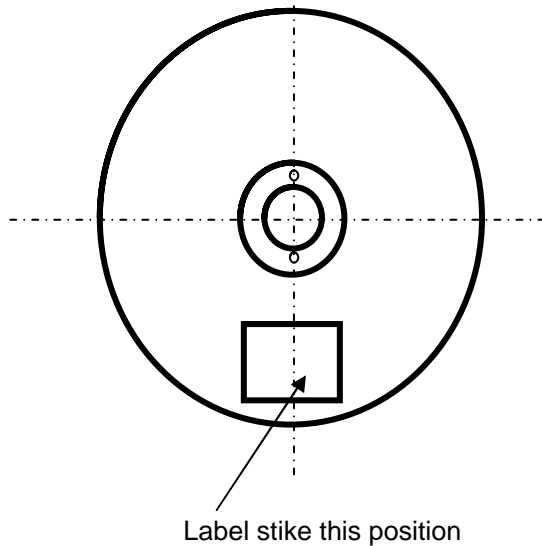

Unit:mm

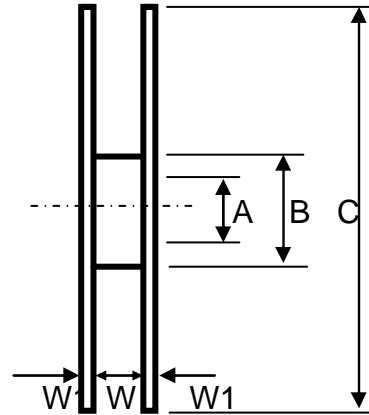

Item	Symbol	Dimension
Dimeter	A	76.4±0.1
	B	82.5±0.2
	C	330±0.5
Width	W	72±0.2
Thickness	W1	3±0.2

B: 外箱规格/Outer Box Specification

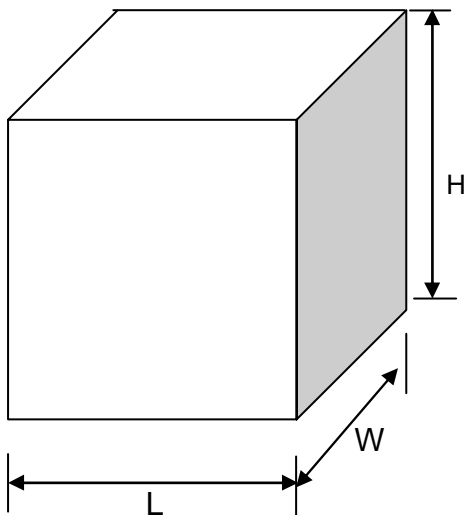

Item	Symbol	Dimension
Size	L	350±2
	W	350±2
	H	340±4

按以上包装方式: (As per the above spec)

	外型/Outside		
	DO-41 & A-405	DO-15	DO-201AD
Q'ty/Taping	5K	4K	1.4K
Q'ty/Packing Case	20K	16K	5.6K

2. 弹带盒装/Ammo Packing

Unit:mm

A: 弹带盒规格/Ammo Box Spec.



Item	Symbol	Dimension	Notes
Box's Size	L	260±2	52mm TYPE
	W	76±2	
	H	100±4	
	L	250±3	26mm TYPE
	W	45±3	
	H	95±5	

B: 外箱规格/Outer Box Specification

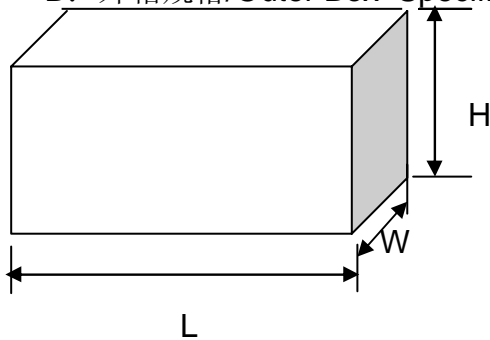

Item	Symbol	Dimension	Notes
Case's Size	L	430±2	52mm TYPE
	W	280±2	
	H	225±4	
	L	435±3	26mm TYPE
	W	280±3	
	H	295±5	

按以上包装方式: (As per the above spec)

	外型/Outside		
	A-405 & DO-41 & R-1	DO-15	DO-201AD
Q'ty/Taping	3K	2K	0.8K
Q'ty/Packing Case 26mm/TYPE	30K	20K	7.2K
Q'ty/Packing Case 52mm/TYPE	60K	40K	14.4K

3. 散装/Bulk Packing

A. 包装盒尺寸/Box Dimension

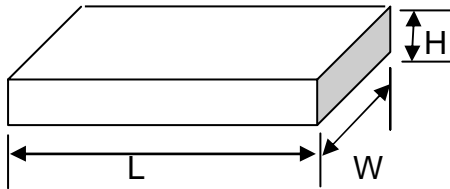

(DO-41&DO-15)

Item	Symbol	Dimension
Box's Size	L	200±2
	W	84±2
	H	21±2

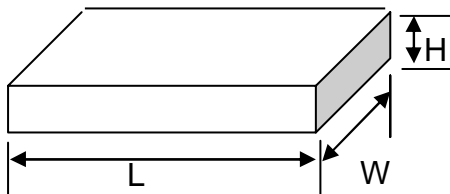

(DO-201AD)

Item	Symbol	Dimension
Box's Size	L	200±2
	W	84±2
	H	29±2

B: 外箱规格/Outer Box Specification

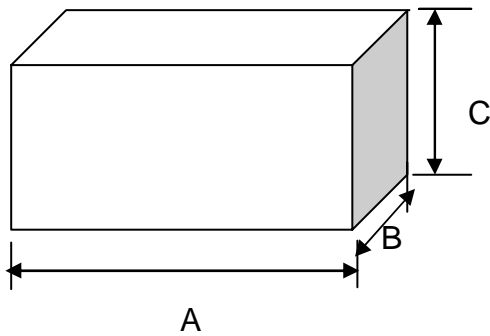

Item	Symbol	Dimension
Case's Size	L	465±2
	W	225±2
	H	260±4

按以上包装方式: (As per the above spec)

	外型/Outside		
	DO-41&A-405&R-1	DO-15	DO-201AD
Q'ty/Taping	1K	0.5K	0.3K
Q'ty/Packing Case	50K	25K	12K

4. 编带图形及规格/Taping Specification

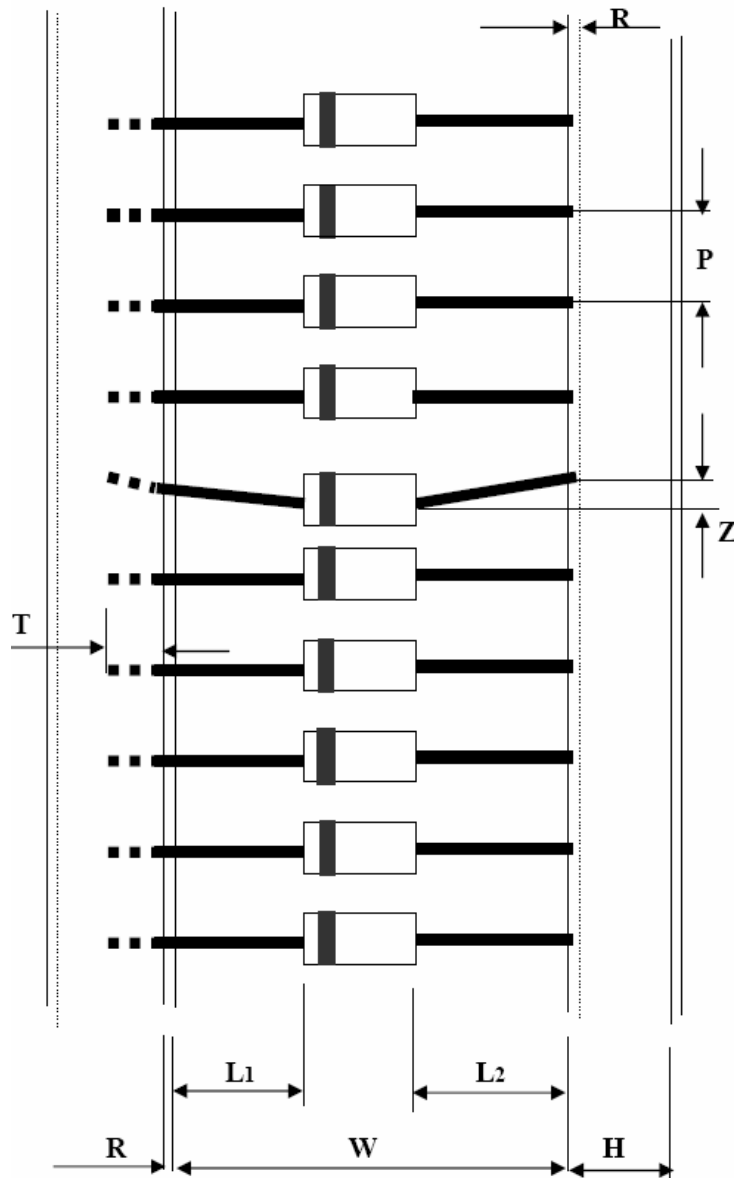

Unit:mm

尺寸代号	编带尺寸/Tape Dimension		
Dimension Code	26/tape	52/tape	52/tape#
W	26 0.0/+1.6	52 -1.0/+2.0	52 -1.0/+2.0
P	5±0.5	5±0.5	10±0.5
L1-L2	<1.0	<1.2	<1.2
H	6±1.0	6±1.0	6±1.0
Z	<1.2	<1.2	<1.2
R	<1.0	<1.0	<1.0
T	>3.2	>3.2	>3.2

注: 52编带# 为DO-201AD编带规格

Remark: 52 tape# is DO-201AD taping spec.