

CED61A3/CEU61A3

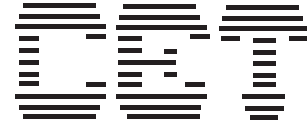

Jan. 2003

N-Channel Logic Level Enhancement Mode Field Effect Transistor

FEATURES

6

- 30V , 40A , $R_{DS(ON)}=13.5m\Omega$ @ $V_{GS}=10V$.
 $R_{DS(ON)}=20m\Omega$ @ $V_{GS}=4.5V$.
- Super high dense cell design for extremely low $R_{DS(ON)}$.
- High power and current handling capability.
- TO-251 & TO-252 package.

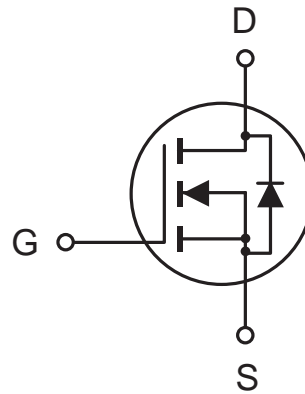

ABSOLUTE MAXIMUM RATINGS ($T_c=25^\circ C$ unless otherwise noted)

Parameter	Symbol	Limit	Unit
Drain-Source Voltage	V_{DS}	30	V
Gate-Source Voltage	V_{GS}	± 20	V
Drain Current-Continuous -Pulsed	I_D	40	A
	I_{DM}	120	A
Drain-Source Diode Forward Current	I_S	40	A
Maximum Power Dissipation @ $T_c=25^\circ C$ Derate above $25^\circ C$	P_D	50	W
		0.4	W/ $^\circ C$
Operating and Storage Temperature Range	T_J, T_{STG}	-55 to 150	$^\circ C$

THERMAL CHARACTERISTICS

Thermal Resistance, Junction-to-Case	$R_{\theta JC}$	2.5	$^\circ C/W$
Thermal Resistance, Junction-to-Ambient	$R_{\theta JA}$	50	$^\circ C/W$

CED61A3/CEU61A3

ELECTRICAL CHARACTERISTICS (Tc=25°C unless otherwise noted)

Parameter	Symbol	Condition	Min	Typ ^c	Max	Unit
OFF CHARACTERISTICS						
Drain-Source Breakdown Voltage	BV _{DSS}	V _{GS} = 0V, I _D = 250μA	30			V
Zero Gate Voltage Drain Current	I _{DSS}	V _{DS} = 30V, V _{GS} = 0V			1	μA
Gate-Body Leakage	I _{GSS}	V _{GS} = ±20V, V _{DS} = 0V			±100	nA
ON CHARACTERISTICS^a						
Gate Threshold Voltage	V _{GS(th)}	V _{DS} = V _{GS} , I _D = 250μA	1		3	V
Drain-Source On-State Resistance	R _{DS(ON)}	V _{GS} = 10V, I _D = 20A		11	13.5	mΩ
		V _{GS} = 4.5V, I _D = 18A		16.5	20	mΩ
On-State Drain Current	I _{D(ON)}	V _{DS} = 10V, V _{GS} = 10V	40			A
Forward Transconductance	g _{FS}	V _{DS} = 10V, I _D = 26A		34		S
DYNAMIC CHARACTERISTICS^b						
Input Capacitance	C _{ISS}	V _{DS} = 15V, V _{GS} = 0V f = 1.0MHz		1200		pF
Output Capacitance	C _{OSS}			480		pF
Reverse Transfer Capacitance	C _{RSS}			130		pF
SWITCHING CHARACTERISTICS^b						
Turn-On Delay Time	t _{D(ON)}	V _{DD} = 15V, I _D = 40A, V _{GS} = 10V R _{GEN} = 24Ω		18	30	ns
Rise Time	t _r			25	50	ns
Turn-Off Delay Time	t _{D(OFF)}			45	90	ns
Fall Time	t _f			75	130	ns
Total Gate Charge	Q _g	V _{DS} = 15V, I _D = 40A V _{GS} = 5V		19	23	nC
Gate-Source Charge	Q _{gs}			5		nC
Gate-Drain Charge	Q _{gd}			9		nC

CED61A3/CEU61A3

ELECTRICAL CHARACTERISTICS ($T_c=25^\circ\text{C}$ unless otherwise noted)

Parameter	Symbol	Condition	Min	Typ	Max	Unit
DRAIN-SOURCE DIODE CHARACTERISTICS ^a						
Diode Forward Voltage	V_{SD}	$V_{GS} = 0\text{V}, I_s = 26\text{A}$		0.9	1.3	V

6

Notes

- a. Pulse Test: Pulse Width $\leq 300 \mu\text{s}$, Duty Cycle $\leq 2\%$.
- b. Guaranteed by design, not subject to production testing.

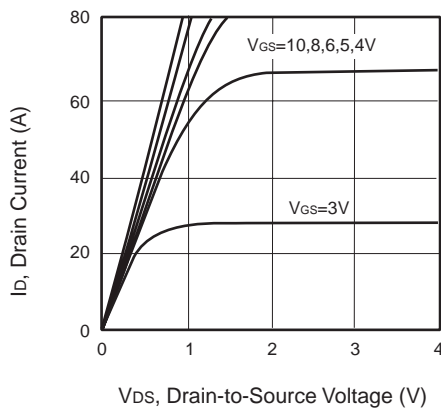

Figure 1. Output Characteristics

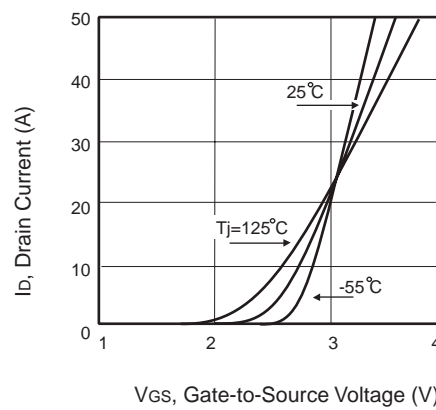

Figure 2. Transfer Characteristics

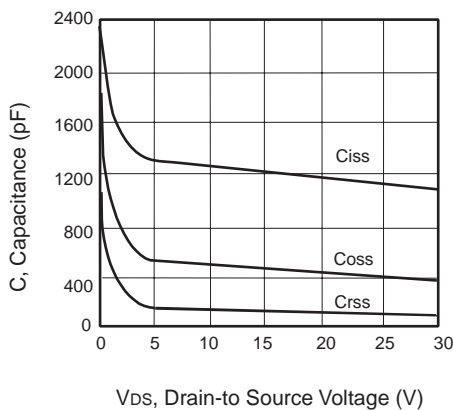

Figure 3. Capacitance

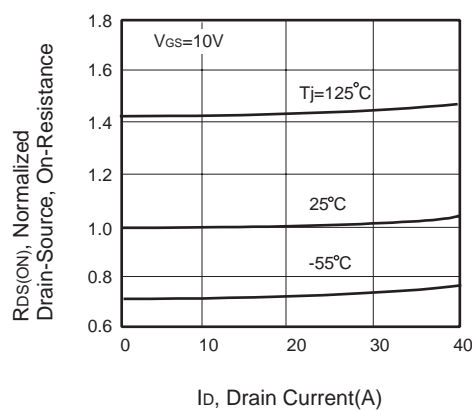

Figure 4. On-Resistance Variation with Drain Current and Temperature

CED61A3/CEU61A3

6

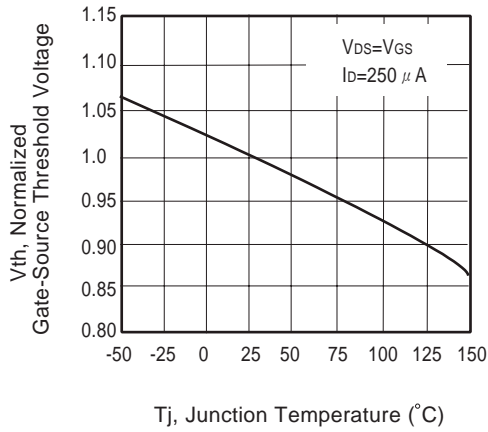

Figure 5. Gate Threshold Variation with Temperature

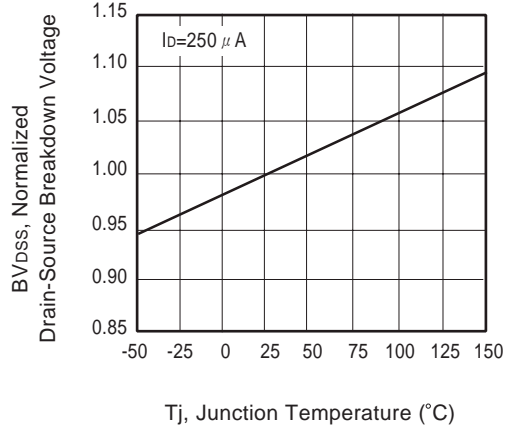

Figure 6. Breakdown Voltage Variation with Temperature

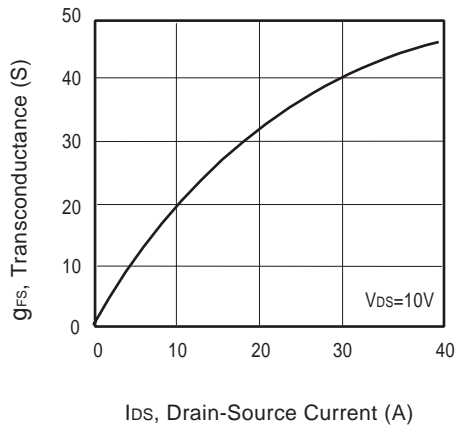

Figure 7. Transconductance Variation with Drain Current

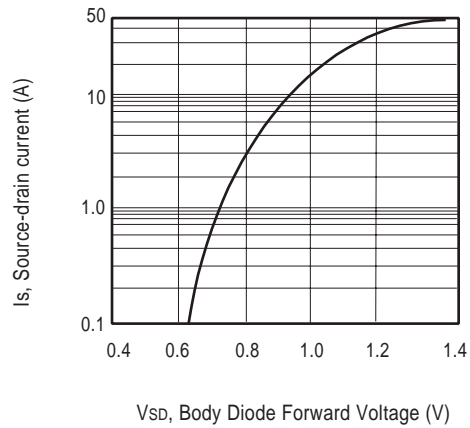

Figure 8. Body Diode Forward Voltage Variation with Source Current

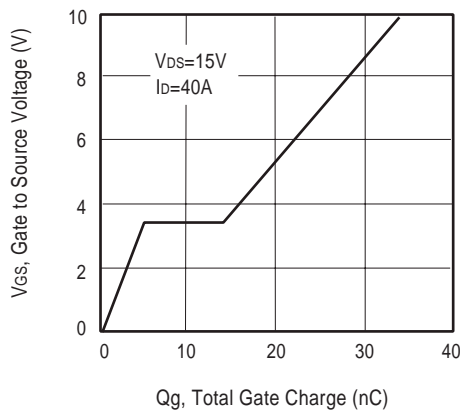

Figure 9. Gate Charge

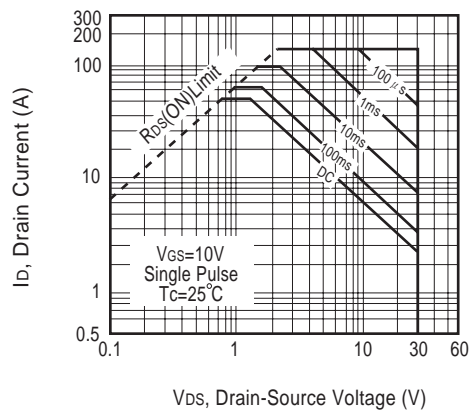

Figure 10. Maximum Safe Operating Area

CED61A3/CEU61A3

6

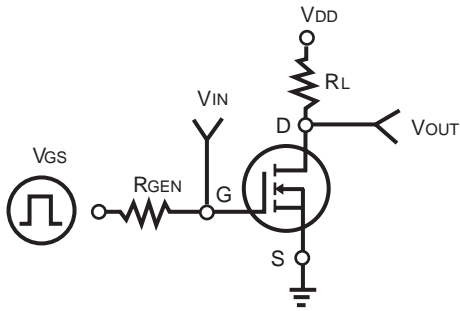

Figure 11. Switching Test Circuit

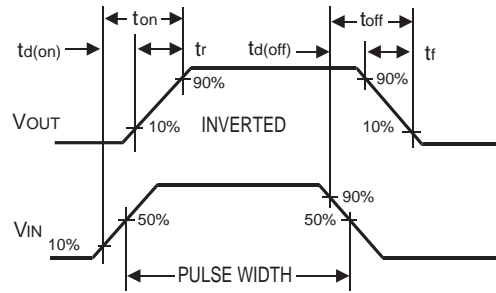

Figure 12. Switching Waveforms

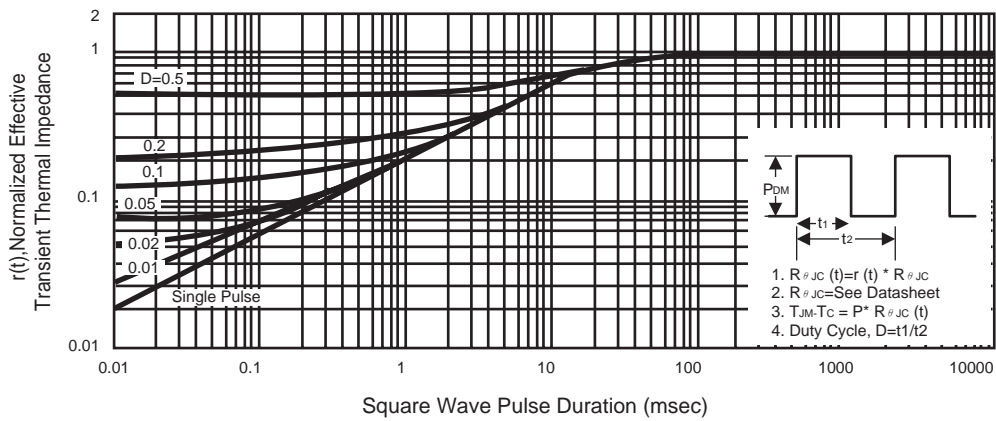

Figure 13. Normalized Thermal Transient Impedance Curve