

GA-M61SME-S2

AMD Athlon™ 64 FX / Athlon™ 64 X2 Dual-Core /
AMD Athlon™ 64 / Sempron™ AM2 Processor Motherboard

User's Manual

Rev. 2002

12ME-M61SMES2-2002R

Declaration of Conformity

G.B.T. Technology, Inc.
Attn: Manufacturer/Importer
We, Manufacturer/Importer
Aussehlager Weg 41, 1F 20527 Hamburg, Germany

(description of the apparatus, system, installation to which it refers)
Motherboard
GA-M61SME-S2
GA-M61SME-S2
(reference to the specification under which conformity is declared)
in accordance with 89/338 EEC/EMC Directive

- | | | | |
|--|--|--|---|
| <input type="checkbox"/> EN 55011 | Limits and methods of measurement of radio disturbance characteristics of household electrical appliances of high frequency equipment | <input checked="" type="checkbox"/> EN 15100-3-2 | Disturbances in supply systems caused by household appliances and similar electrical equipment "Voltage fluctuations" |
| <input type="checkbox"/> EN 55013 | Limits and methods of measurement of radio disturbance characteristics of broadcast receivers and associated equipment | <input checked="" type="checkbox"/> EN 55014-2 | Immunity requirements for household appliances (see also similar systems in industrial environment) |
| <input type="checkbox"/> EN 55014-1 | Limits and methods of measurement of radio disturbance characteristics of portable tools and similar electrical apparatus | <input type="checkbox"/> EN 55019-2 | EMC requirements for unintermittible power systems (UPS) |
| <input type="checkbox"/> EN 55015 | Limits and methods of measurement of radio disturbance characteristics of fluorescent lamps and luminaires | <input type="checkbox"/> EN 55019-1-2 | EMC requirements for unintermittible power systems (UPS) |
| <input type="checkbox"/> EN 55020 | Immunity from radio interference of broadcast receivers and associated equipment | <input type="checkbox"/> EN 55019-2 | EMC requirements for unintermittible power systems (UPS) |
| <input checked="" type="checkbox"/> EN 55022 | Limits and methods of measurement of radio disturbance characteristics of information technology equipment for receiving and/or distribution from sound and television signals | <input type="checkbox"/> EN 55019-2 | EMC requirements for unintermittible power systems (UPS) |
| <input type="checkbox"/> IEC 60965 | Calibrated distribution systems, Equipment for receiving and/or distribution from sound and television signals | <input type="checkbox"/> EN 55019-2 | EMC requirements for unintermittible power systems (UPS) |
| <input type="checkbox"/> EN 60965 | Safety requirements for mains operated household and similar general use electrical appliances | <input checked="" type="checkbox"/> EN 60969 | Safety for information technology equipment including electrical business equipment |
| <input type="checkbox"/> EN 60335 | Safety of household and similar electrical appliances | <input type="checkbox"/> EN 55019-1 | General and safety requirements for unintermittible power systems (UPS) |



(EC conformity marking)

The manufacturer also declares the conformity of above mentioned product with the safety required safety standards in accordance with IEC 60969/IEC

(Stamp)

Date: Mar. 7, 2007

Manufacturer/Importer

Signature: Timmy Huang

Name: Timmy Huang

DECLARATION OF CONFORMITY

Per FCC Part 2, Section 2.1077(a)



Responsible Party Name: **G.B.T. INC. (U.S.A.)**

Address: **17358 Railroad Street**

City of Industry, **CA 91748**

Phone/Fax No: **(818) 854-9338/ (818) 854-9339**

hereby declares that the product

Product Name: Motherboard

Model Number: GA-M61SME-S2

Conforms to the following specifications:

FCC Part 15, Subpart B, Section 15.107(a) and Section 15.109

(a), Class B Digital Device

Supplementary Information:

This device complies with part 15 of the FCC Rules. Operation is subject to the following two conditions: (1) This device may not cause harmful and (2) this device must accept any interference received, including that may cause undesired operation.

Representative Person's Name: ERIC LU

Signature: Eric Lu

Date: Mar. 7, 2007

Copyright

© 2007 GIGA-BYTE TECHNOLOGY CO., LTD. All rights reserved.

The trademarks mentioned in the manual are legally registered to their respective companies.

Notice

The written content provided with this product is the property of Gigabyte.

No part of this manual may be reproduced, copied, translated, or transmitted in any form or by any means without Gigabyte's prior written permission. Specifications and features are subject to change without prior notice.

Product Manual Classification

In order to assist in the use of this product, Gigabyte has categorized the user manual in the following:

- For detailed product information and specifications, please carefully read the "Product User Manual".

- For detailed information related to Gigabyte's unique features, please go to the "Technology Guide" section on Gigabyte's website to read or download the information you need.

For more product details, please click onto Gigabyte's website at www.gigabyte.com.tw

Table of Contents

Optional Items	6
Box Contents	6
GA-M61SME-S2 Motherboard Layout	7
Block Diagram	8
Chapter 1 Hardware Installation	9
1-1 Considerations Prior to Installation	9
1-2 Feature Summary	10
1-3 Installation of the CPU and CPU Cooler	12
1-3-1 Installation of the CPU	12
1-3-2 Installation of the CPU Cooler	13
1-4 Installation of Memory	14
1-5 Installation of Expansion Cards	15
1-6 I/O Back Panel Introduction	17
1-7 Connectors Introduction	18
Chapter 2 BIOS Setup	29
The Main Menu (For example: BIOS Ver. : E7)	30
2-1 Standard CMOS Features	32
2-2 Advanced BIOS Features	34
2-3 Integrated Peripherals	36
2-4 Power Management Setup	39
2-5 PnP/PCI Configurations	41
2-6 PC Health Status	42
2-7 Load Fail-Safe Defaults	44
2-8 Load Optimized Defaults	44
2-9 Set Supervisor/User Password	45
2-10 Save & Exit Setup	46
2-11 Exit Without Saving	46

- Chapter 3 Drivers Installation 47
 - 3-1 Install Chipset Drivers 47
 - 3-2 Software Applications 48
 - 3-3 Driver CD Information 48
 - 3-4 Hardware Information 49
 - 3-5 Contact Us 49

- Chapter 4 Appendix 51
 - 4-1 Unique Software Utilities 51
 - 4-1-1 EasyTune 5 Introduction 51
 - 4-1-2 Xpress Recovery2 Introduction 52
 - 4-1-3 Flash BIOS Method Introduction 54
 - 4-1-4 Configuring SATA Hard Drive(s) 58
 - 4-1-5 2- / 4- / 6- / 8- Channel Audio Introduction 68
 - 4-2 Troubleshooting 74
 - 4-2-1 Frequently Asked Questions 74
 - 4-2-2 Troubleshooting Procedure 75

- Regulatory Statements 77

Box Contents

- GA-M61SME-S2 motherboard
- Motherboard driver disk
- User's Manual
- One IDE cable and one floppy disk drive cable
- One SATA 3Gb/s cables
- I/O Shield

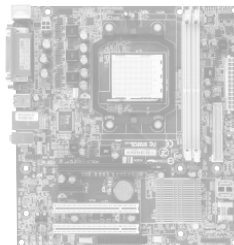

The box contents above are for reference only and the actual items shall depend on product package you obtain.
The box contents are subject to change without notice.

Optional Items

- 2-port USB 2.0 bracket (Part No. 12CR1-1UB030-51R)
- 2-port SATA power cable (Part No. 12CF1-2SERPW-01R)
- COM port cable (Part No. 12CF1-1CM001-32R)
- S/PDIF In and Out Cable (Part Number: 12CR1-1SPINO-11R)
- 5.1/7.1 Surround Cable (Part Number: 12CF1-1AU004-01R)

GA-M61SME-S2 Motherboard Layout

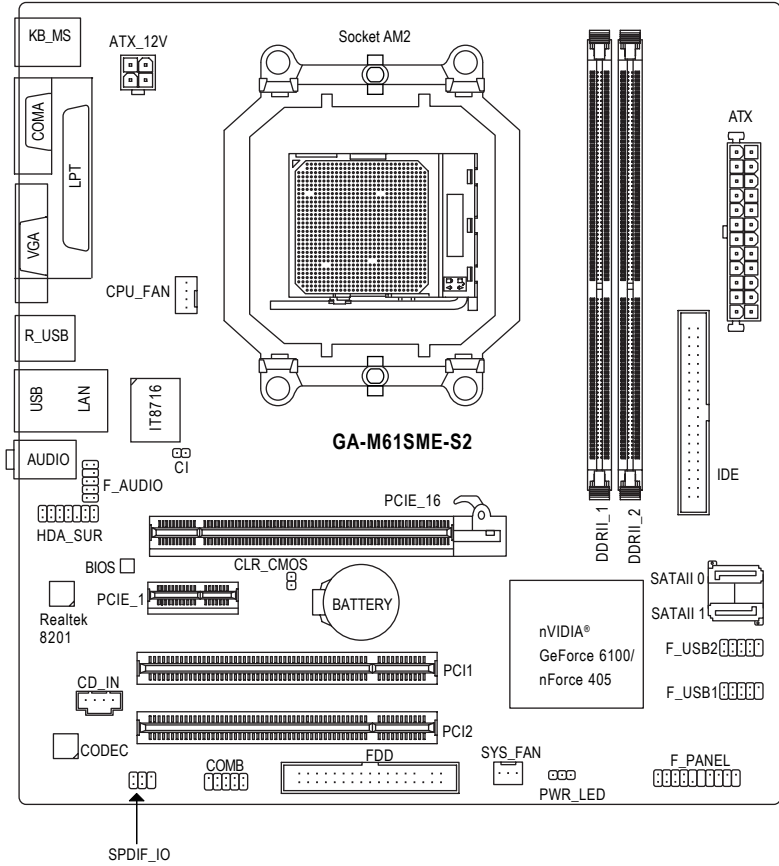

Block Diagram

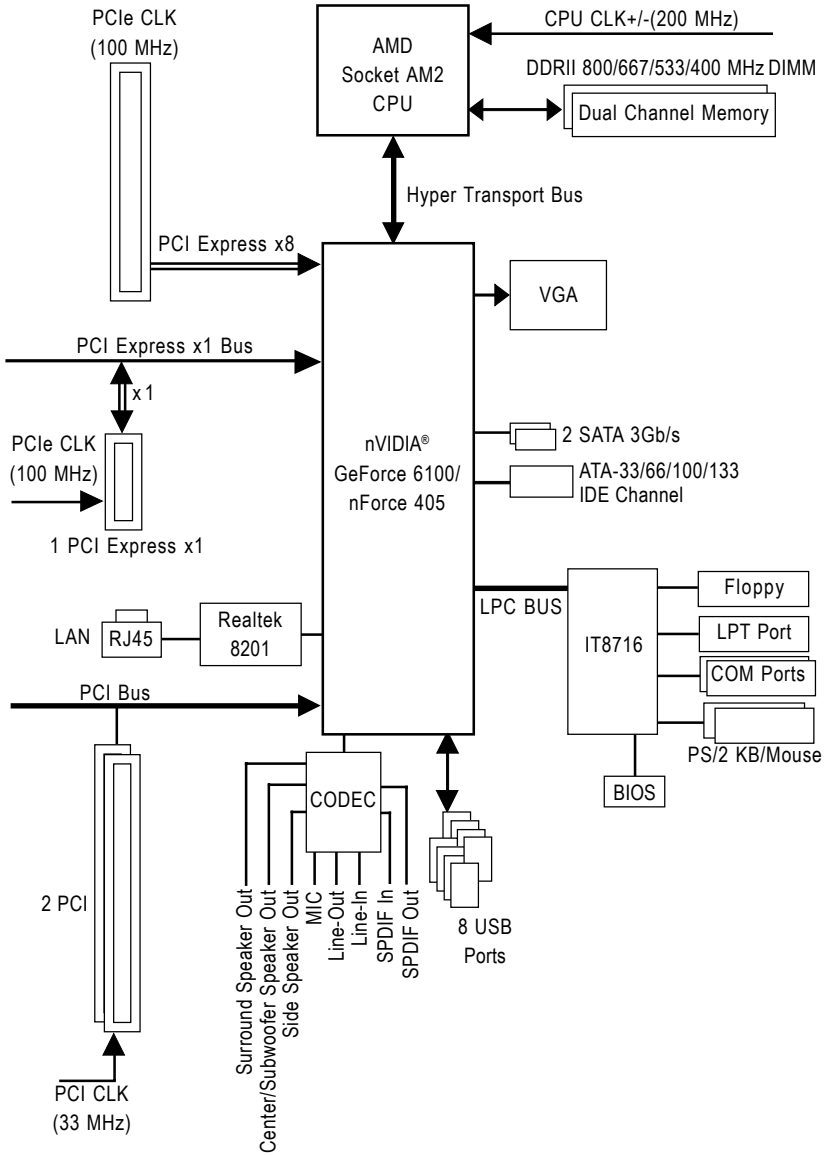

Chapter 1 Hardware Installation

1-1 Considerations Prior to Installation

Preparing Your Computer

The motherboard contains numerous delicate electronic circuits and components which can become damaged as a result of electrostatic discharge (ESD). Thus, prior to installation, please follow the instructions below:

1. Please turn off the computer and unplug its power cord.
2. When handling the motherboard, avoid touching any metal leads or connectors.
3. It is best to wear an electrostatic discharge (ESD) cuff when handling electronic components (CPU, RAM).
4. Prior to installing the electronic components, please have these items on top of an antistatic pad or within a electrostatic shielding container.
5. Please verify that the power supply is switched off before unplugging the power supply connector from the motherboard.

Installation Notices

1. Prior to installation, please do not remove the stickers on the motherboard. These stickers are required for warranty validation.
2. Prior to the installation of the motherboard or any hardware, please first carefully read the information in the provided manual.
3. Before using the product, please verify that all cables and power connectors are connected.
4. To prevent damage to the motherboard, please do not allow screws to come in contact with the motherboard circuit or its components.
5. Please make sure there are no leftover screws or metal components placed on the motherboard or within the computer casing.
6. Please do not place the computer system on an uneven surface.
7. Turning on the computer power during the installation process can lead to damage to system components as well as physical harm to the user.
8. If you are uncertain about any installation steps or have a problem related to the use of the product, please consult a certified computer technician.

Instances of Non-Warranty

1. Damage due to natural disaster, accident or human cause.
2. Damage as a result of violating the conditions recommended in the user manual.
3. Damage due to improper installation.
4. Damage due to use of uncertified components.
5. Damage due to use exceeding the permitted parameters.
6. Product determined to be an unofficial Gigabyte product.

1-2 Feature Summary

CPU	<ul style="list-style-type: none">◆ Socket AM2 for AMD Athlon™ 64 FX / Athlon™ 64 X2 Dual-Core / Athlon™ 64 / Sempron™ processor
Front Side Bus	<ul style="list-style-type: none">◆ 2000 MHz
Chipset	<ul style="list-style-type: none">◆ nVIDIA® GeForce 6100/nForce 405 chipset
LAN	<ul style="list-style-type: none">◆ Realtek 8201 phy (10/100 Mbit)
Audio	<ul style="list-style-type: none">◆ Onboard Realtek ALC883 CODEC chip◆ Supports High Definition Audio◆ Supports 2 / 4 / 6 / 8 channel audio ^(Note 1)◆ Supports S/PDIF In/Out connection◆ Supports CD In connection
Storage	<ul style="list-style-type: none">◆ nVIDIA® GeForce 6100/nForce 405 chipset<ul style="list-style-type: none">- 1 FDD connector, allowing connection of 1 FDD device- 1 IDE connector with ATA-33/66/100/133 support, allowing connection of 2 IDE devices- 2 SATA 3Gb/s connectors, allowing connection of 2 SATA 3Gb/s devices- Supports data striping (RAID 0) and mirroring (RAID 1) for Serial ATA
O.S Support	<ul style="list-style-type: none">◆ Microsoft Windows 2000/XP/Vista
Memory	<ul style="list-style-type: none">◆ 2 DDRII DIMM memory slots (supports up to 8 GB memory) ^(Note 2)◆ Supports dual channel DDRII 800/667/533/400 DIMMs◆ Supports 1.8V DDRII DIMMs
Expansion Slots	<ul style="list-style-type: none">◆ 1 PCI Express x16 slot ^(Note 3)◆ 1 PCI Express x1 slot◆ 2 PCI slots
Internal Connectors	<ul style="list-style-type: none">◆ 1 24-pin ATX power connector◆ 1 4-pin ATX 12V power connector◆ 1 floppy connector◆ 1 IDE connector◆ 2 SATA 3Gb/s connectors◆ 1 CPU fan connector◆ 1 system fan connector◆ 1 front panel connector◆ 1 front audio connector◆ 1 CD In connector◆ 1 S/PDIF In/Out connector◆ 1 HDA_SUR connector◆ 1 COMB connector◆ 1 power LED connector◆ 2 USB 2.0/1.1 connectors for additional 4 USB 2.0/1.1 ports by cables◆ 1 Chassis Intrusion connector

Rear Panel I/O	<ul style="list-style-type: none"> ◆ 1 PS/2 keyboard port ◆ 1 PS/2 mouse port ◆ 1 parallel port ◆ 1 COMA port ◆ 1 VGA port ◆ 4 USB 2.0/1.1 ports ◆ 1 RJ-45 port ◆ 3 audio jacks (Line In / Line Out / MIC In)
I/O Control	<ul style="list-style-type: none"> ◆ IT8716 chip
Hardware Monitor	<ul style="list-style-type: none"> ◆ System voltage detection ◆ CPU / System temperature detection ◆ CPU / System fan speed detection ◆ CPU / System warning temperature ◆ CPU / System fan failure warning ◆ Supports CPU Smart Fan function ^(Note 4)
BIOS	<ul style="list-style-type: none"> ◆ 1 4 Mbit flash ROM ◆ Use of licensed AWARD BIOS ◆ PnP 1.0a, DMI 2.0, SM BIOS 2.3, ACPI 1.0b
Additional Features	<ul style="list-style-type: none"> ◆ Supports @BIOS ◆ Supports Download Center ◆ Supports Q-Flash ◆ Supports EasyTune ^(Note 5) ◆ Supports Xpress Install ◆ Supports Xpress Recovery2 ◆ Supports Xpress BIOS Rescue
Bundle Software	<ul style="list-style-type: none"> ◆ Norton Internet Security (OEM version)
Form Factor	<ul style="list-style-type: none"> ◆ Micro ATX form factor; 24.4cm x 22.5cm

(Note 1) To set up an 8 channel audio configuration, you must use 5.1/7.1 Surround Cable (optional).

(Note 2) Due to the limitation of Windows 32-bit operating system, when more than 4 GB of physical memory is installed, the actual memory available for the operating system will be less than 4 GB; Windows 64-bit operating system doesn't have such limitation.

(Note 3) The GA-M61SME-S2 supports up to PCI Express x8 mode. (please refer to the VGA cards support list on page 16~17)

(Note 4) Whether the CPU Smart FAN Control function is supported will depend on the CPU you install.

(Note 5) EasyTune functions may vary depending on different motherboards.

1-3 Installation of the CPU and CPU Cooler



Before installing the CPU, please comply with the following conditions:

1. Please make sure that the motherboard supports the CPU.
2. Please take note of the pin 1 marking (the small triangle) on the CPU. If you install the CPU in the wrong direction, the CPU will not insert properly. If this occurs, please change the insert direction of the CPU.
3. Please add an even layer of heat paste between the CPU and CPU cooler.
4. Please make sure the CPU cooler is installed on the CPU prior to system use, otherwise overheating and permanent damage of the CPU may occur.
5. Please set the CPU host frequency in accordance with the processor specifications. It is not recommended that the system bus frequency be set beyond hardware specifications since it does not meet the required standards for the peripherals. If you wish to set the frequency beyond the proper specifications, please do so according to your hardware specifications including the CPU, graphics card, memory, hard drive, etc.

1-3-1 Installation of the CPU

Check the CPU pins to see that none are bent. Move the socket lever to the unlocked position as shown in Fig. 1 (90° to the plane of the motherboard) prior to inserting the CPU. The pin 1 location is designated on the CPU by a small triangle that corresponds to a triangle marking on the socket as shown in Fig. 2. Align the CPU to the socket and gently lower it into place. Do not force the CPU into the socket.

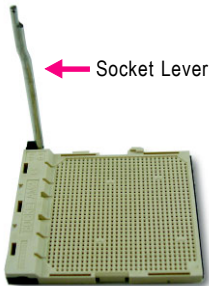

Fig.1

Position lever at a 90 degree angle.

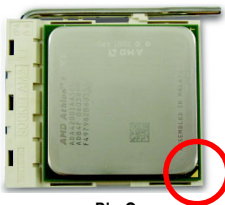

Fig.2

Pin 1 location on the socket and CPU.

Gently place the CPU into position making sure that the CPU pins fit perfectly into their holes. Once the CPU is positioned into its socket, place one finger down on the middle of the CPU and gently press the metal lever back into its original position.

Pin One



Please use extra care when installing the CPU. The CPU will not fit if positioned incorrectly. Rather than applying force, please change the positioning of the CPU.

1-3-2 Installation of the CPU Cooler



Fig.1

Before installing the CPU cooler, please first add an even layer of heat paste on the surface of the CPU. Install all the CPU cooler components (Please refer to the cooler manual for detailed installation instructions).

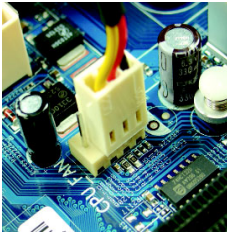

Fig.2

Please connect the CPU cooler power connector to the CPU_FAN connector located on the motherboard so that the CPU cooler can properly function to prevent CPU overheating.



The CPU cooler may adhere to the CPU as a result of hardening of the heat paste. To prevent such an occurrence, it is suggested that either thermal tape rather than heat paste be used for heat dissipation or using extreme care when removing the CPU cooler.

1-4 Installation of Memory



Before installing the memory modules, please comply with the following conditions:

1. Please make sure that the memory used is supported by the motherboard. It is recommended that memory of similar capacity, specifications and brand be used.
2. Before installing or removing memory modules, please make sure that the computer power is switched off to prevent hardware damage.
3. Memory modules have a foolproof insertion design. A memory module can be installed in only one direction. If you are unable to insert the module, please switch the direction.

The motherboard supports DDRII memory modules, whereby BIOS will automatically detect memory capacity and specifications. Memory modules are designed so that they can be inserted only in one direction. The memory capacity used can differ with each slot.

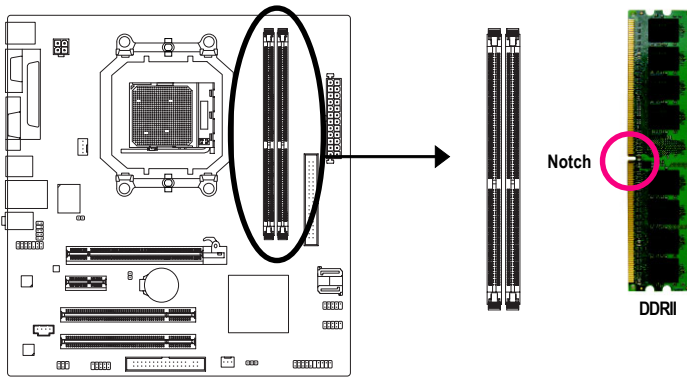

Fig.1

The DIMM socket has a notch, so the DIMM memory module can only fit in one direction. Insert the DIMM memory module vertically into the DIMM socket. Then push it down.

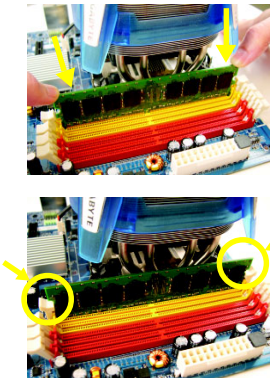

Fig.2

Close the plastic clip at both edges of the DIMM sockets to lock the DIMM module.

Reverse the installation steps when you wish to remove the DIMM module.



Dual Channel Memory Configuration

The GA-M61SME-S2 supports the Dual Channel Technology. After operating the Dual Channel Technology, the bandwidth of Memory Bus will double.

Due to CPU limitation, if you wish to operate the Dual Channel Technology, follow the guidelines below:

1. Dual Channel mode will not be enabled if only one memory module is installed.
2. To enable Dual Channel mode with two memory modules, it is recommended to use memory modules of identical brand, size, chips and speed.

1-5 Installation of Expansion Cards

You can install your expansion card by following the steps outlined below:

1. Read the related expansion card's instruction document before install the expansion card into the computer.
2. Remove your computer's chassis cover, screws and slot bracket from the computer.
3. Press the expansion card firmly into expansion slot in motherboard.
4. Be sure the metal contacts on the card are indeed seated in the slot.
5. Replace the screw to secure the slot bracket of the expansion card.
6. Replace your computer's chassis cover.
7. Power on the computer, if necessary, setup BIOS utility of expansion card from BIOS.
8. Install related driver from the operating system.

Installing a PCI Express x16 expansion card:

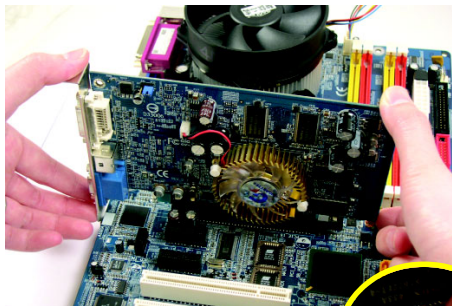

Please align the VGA card to the onboard PCI Express x16 slot and press firmly down on the slot. Make sure your VGA card is locked by the latch at the end of the PCI Express x16 slot. When you try uninstall the VGA card, please press the latch as the picture to the left shows to release the card.

PCI Express x16 Graphics Card Support List

The items below are all supported under the Windows XP operating system. When using an add-on graphics card, please first delete the onboard graphics driver before installing the driver for the add-on graphics card.

Graphics Chip	Maker	Model Name
Nvidia	Gigabyte	GV-NX53128D
	Gigabyte	GV-NX57128D
	Gigabyte	GV-NX59128D
	Gigabyte	GV-NX62128D
	Gigabyte	GV-NX66128DP2
	Gigabyte	GV-NX66T128D
	Gigabyte	GV-NX68T256DH
	Gigabyte	GV-NX55128DP
	Gigabyte	GV-NX68U256D-B
	Gigabyte	GV-NX62TC128D
	Gigabyte	GV-3D1
	Gigabyte	GV-NX66L128DP
	Gigabyte	GV-NX68256D
	Gigabyte	GV-NX78X256V-B
	Gigabyte	GV-NX78T256V-B
	Gigabyte	GV-NX79T256DP-RH
	Gigabyte	GV-NX76T256D-RH
	Gigabyte	GV-NX76G256D-RH
	Gigabyte	GV-NX73T256D-RH
	Gigabyte	GV-NX73G128D-RH
	Gigabyte	GV-NX73L128D-RH
	Gigabyte	GV-NX65128DE
	Gigabyte	GV-NX79G256DP-RH
	Gigabyte	GV-NX71G512P8-RH
	Nvidia	7900GTX
	Nvidia	8800GTX
	Nvidia	P502/P602
ASUS	EN6600GT/TD/128	
ASUS	EN6600/TD/128	
MSI	NX6800GT-TD256E	
Leadtek	WinFast PX6600GT TDH	
ELSA	GLADIAC 760GT	
ELSA	GLADIAC 790GT	
Ati	Gigabyte	GV-RX30S128D
	Gigabyte	GV-RX30HM128D
	Gigabyte	GV-RX30128D
	Gigabyte	GV-RX60P128DE
	Gigabyte	GV-RX60X128V
	Gigabyte	GV-RX70128D
	Gigabyte	GV-RX70P128D
	Gigabyte	GV-RX80T256V
	Gigabyte	GV-RX80L256V
	Gigabyte	GV-RX80256D
	Gigabyte	GV-RX55128D
	Gigabyte	GV-RX85T256V-B
	Gigabyte	GV-RC850T256D-B

Graphics Chip	Maker	Model Name
ATI	Gigabyte	GV-RX13P256D-RH
	Gigabyte	GV-RX16P256DE-RH
	Gigabyte	GV-RX18L256V-B
	Gigabyte	GV-RX18T512V-B
	Gigabyte	GV-RC19T512B-RH
	Gigabyte	GV-RX165T256D-RH
	Gigabyte	GV-RX13128D-RH
	Gigabyte	GV-RX195P256D-RH
	Gigabyte	GV-RX165P256D-RH
	Gigabyte	GV-RX16T256V-RH
	ASUS	AX800XT
	ASUS	AX700PRO
	MSI	RX600 XT-TD128
VIA	S3	GammaChrome S18

1-6 I/O Back Panel Introduction

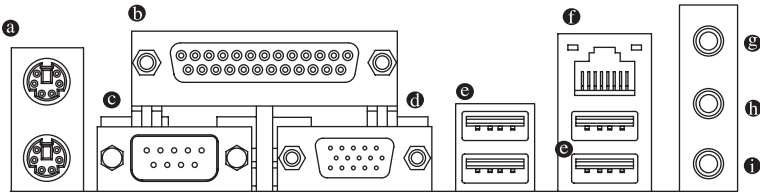

a PS/2 Keyboard and PS/2 Mouse Connector

To install a PS/2 port keyboard and mouse, plug the mouse to the upper port (green) and the keyboard to the lower port (purple).

b Parallel Port

The parallel port allows connection of a printer, scanner and other peripheral devices.

c Serial Port

Devices like mice, modems, and etc. can be connected to Serial port.

d VGA Port

Monitor can be connected to VGA port.

e USB Port

Before you connect your device(s) into USB connector(s), please make sure your device(s) such as USB keyboard, mouse, scanner, zip, speaker...etc. have a standard USB interface. Also make sure your OS supports USB controller. If your OS does not support USB controller, please contact OS vendor for possible patch or driver upgrade. For more information please contact your OS or device(s) vendors.

f LAN Port

The provided Internet connection is Fast Ethernet, supporting data transfer speeds of 10/100 Mbps.

g Line In

Devices like CD-ROM, walkman etc. can be connected to Line In jack.

④ Line Out (Front Speaker Out)

Connect the stereo speakers, earphone or front surround speakers to this connector.

④ MIC In

Microphone can be connected to MIC In jack.



NOTE

1. You can use audio software to configure 2-/4-/6-/8-channel audio functioning.
2. To set up an 8 channel audio configuration, you must use 5.1/7.1 Surround Cable (optional).

1-7 Connectors Introduction

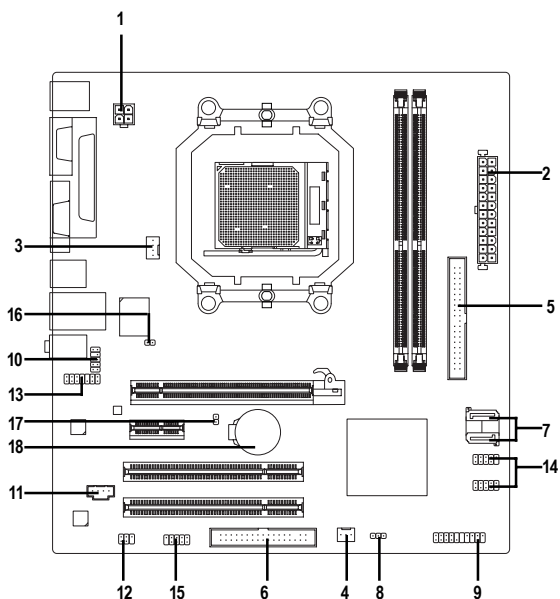

1) ATX_12V	10) F_AUDIO
2) ATX (Power Connector)	11) CD_IN
3) CPU_FAN	12) SPDIF_IO
4) SYS_FAN	13) HDA_SUR
5) IDE	14) F_USB1 / F_USB2
6) FDD	15) COMB
7) SATAII 0 / SATAII 1	16) CI
8) PWR_LED	17) CLR_CMOS
9) F_PANEL	18) BATTERY

1/2) ATX_12V/ATX (Power Connector)

With the use of the power connector, the power supply can supply enough stable power to all the components on the motherboard. Before connecting the power connector, please make sure that all components and devices are properly installed. Align the power connector with its proper location on the motherboard and connect tightly.

The ATX_12V power connector mainly supplies power to the CPU. If the ATX_12V power connector is not connected, the system will not start.

Caution!

Please use a power supply that is able to handle the system voltage requirements. It is recommended that a power supply that can withstand high power consumption be used (300W or greater). If a power supply is used that does not provide the required power, the result can lead to an unstable system or a system that is unable to start.

If you use a 24-pin ATX power supply, please remove the small cover on the power connector on the motherboard before plugging in the power cord; otherwise, please do not remove it.

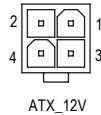
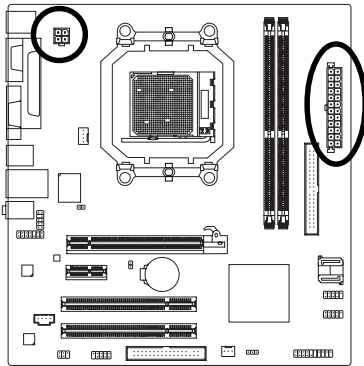

Pin No.	Definition
1	GND
2	GND
3	+12V
4	+12V

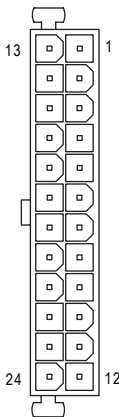

ATX

Pin No.	Definition	Pin No.	Definition
1	3.3V	13	3.3V
2	3.3V	14	-12V
3	GND	15	GND
4	+5V	16	PS_ON(soft On/Off)
5	GND	17	GND
6	+5V	18	GND
7	GND	19	GND
8	Power Good	20	-5V
9	5V SB(stand by +5V)	21	+5V
10	+12V	22	+5V
11	+12V(Only for 24-pin ATX)	23	+5V (Only for 24-pin ATX)
12	3.3V(Only for 24-pin ATX)	24	GND(Only for 24-pin ATX)

3/4) CPU_FAN / SYS_FAN (Cooler Fan Power Connector)

The cooler fan power connector supplies a +12V power voltage via a 3-pin/4-pin (only for CPU_FAN) power connector and possesses a foolproof connection design.

Most coolers are designed with color-coded power connector wires. A red power connector wire indicates a positive connection and requires a +12V power voltage. The black connector wire is the ground wire (GND).

Remember to connect the CPU/system fan cable to the CPU_FAN/SYS_FAN connector to prevent CPU damage or system hanging caused by overheating.

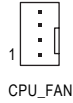
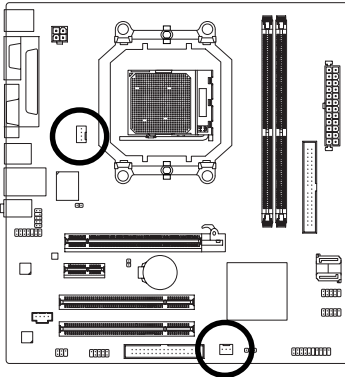

GPU_FAN:

Pin No.	Definition
1	GND
2	+12V/Speed Control
3	Sense
4	Speed Control

SYS_FAN:

Pin No.	Definition
1	GND
2	+12V
3	Sense

5) IDE (IDE Connector)

An IDE device connects to the computer via an IDE connector. One IDE connector can connect to one IDE cable, and the single IDE cable can then connect to two IDE devices (hard drive or optical drive). If you wish to connect two IDE devices, please set the jumper on one IDE device as Master and the other as Slave (for information on settings, please refer to the instructions located on the IDE device). Before attaching the IDE cable, please take note of the foolproof groove in the IDE connector.

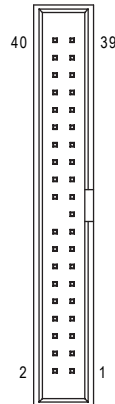
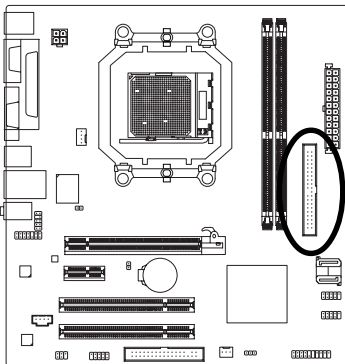

6) FDD (FDD Connector)

This connector is used to connect a floppy disk drive. The types of floppy disk drives supported are: 360 KB, 720 KB, 1.2 MB, 1.44 MB, and 2.88 MB. Before connecting a floppy disk drive, be sure to locate pin 1 of the connector and the floppy disk drive cable. The pin 1 of the cable is typically designated by a stripe of different color.

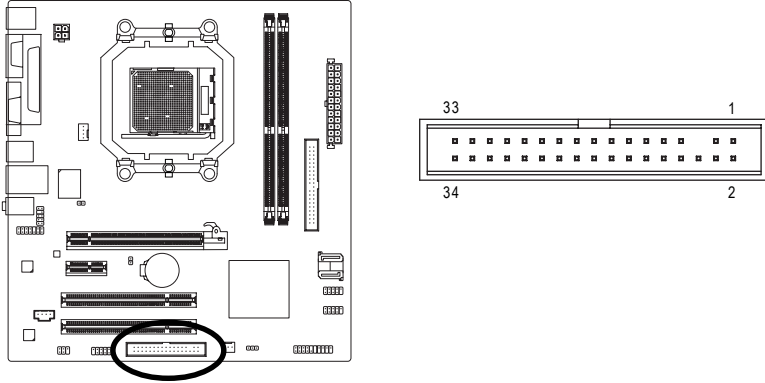

7) SATAII 0 / SATAII 1 (SATA 3Gb/s Connectors)

SATA 3Gb/s can provide up to 300 MB/s transfer rate. Please refer to the BIOS setting for the SATA 3Gb/s and install the proper driver in order to work properly.

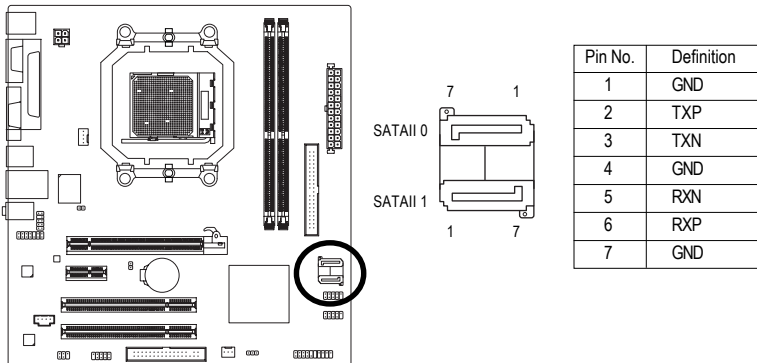

8) PWR_LED

The PWR_LED connector is connected with the system power indicator to indicate whether the system is on/off. It will blink when the system enters suspend mode(S1).

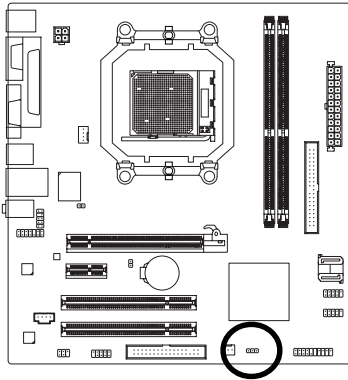

Pin No.	Definition
1	MPD+
2	MPD-
3	MPD-

9) F_PANEL (Front Panel Jumper)

Please connect the power LED, PC speaker, reset switch and power switch etc. of your chassis front panel to the F_PANEL connector according to the pin assignment below.

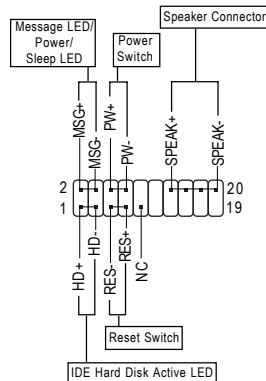
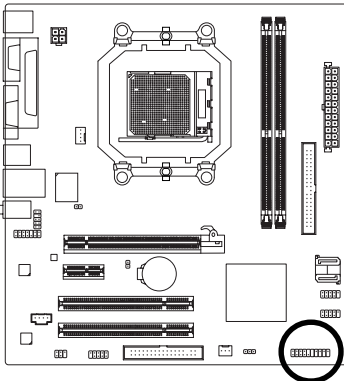

HD (IDE Hard Disk Active LED)	Pin 1: LED anode(+) Pin 2: LED cathode(-)
SPEAK (Speaker Connector)	Pin 1: Power Pin 2- Pin 3: NC Pin 4: Data(-)
RES (Reset Switch)	Open: Normal Close: Reset Hardware System
PW (Power Switch)	Open: Normal Close: Power On/Off
MSG (Message LED/Power/Sleep LED)	Pin 1: LED anode(+) Pin 2: LED cathode(-)
NC	NC

10) F_AUDIO (Front Audio Connector)

This connector supports either HD (High Definition) or AC97 front panel audio module. If you wish to use the front audio function, connect the front panel audio module to this connector. Check the pin assignments carefully while you connect the front panel audio module. Incorrect connection between the module and connector will make the audio device unable to work or even damage it. For optional front panel audio module, please contact your chassis manufacturer.

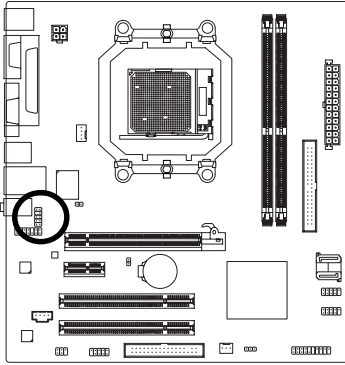

HD Audio:

Pin No.	Definition
1	MIC2_L
2	GND
3	MIC2_R
4	-ACZ_DET
5	LINE2_R
6	FSENSE1
7	FAUDIO_JD
8	No Pin
9	LINE2_L
10	FSENSE2

AC'97 Audio:

Pin No.	Definition
1	MIC
2	GND
3	MIC Power
4	NC
5	Line Out (R)
6	NC
7	NC
8	No Pin
9	Line Out (L)
10	NC



By default, the audio driver is configured to support HD Audio. To connect an AC97 front panel audio module to this connector, please refer to the instructions on Page 73 about the software settings.

11) CD_IN (CD In Connector)

Connect CD-ROM or DVD-ROM audio out to the connector.

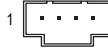
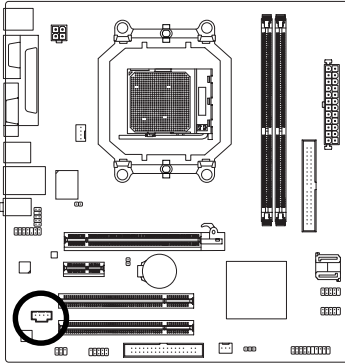

Pin No.	Definition
1	CD-L
2	GND
3	GND
4	CD-R

12) SPDIF_IO (S/PDIF In/Out Connector)

The S/PDIF output is capable of providing digital audio to external speakers or compressed AC3 data to an external Dolby Digital Decoder. Use this feature only when your stereo system has digital input function. Use S/PDIF IN feature only when your device has digital output function. Be careful with the polarity of the SPDIF_IO connector. Check the pin assignment carefully while you connect the S/PDIF cable, incorrect connection between the cable and connector will make the device unable to work or even damage it. For optional S/PDIF cable, please contact your local dealer.

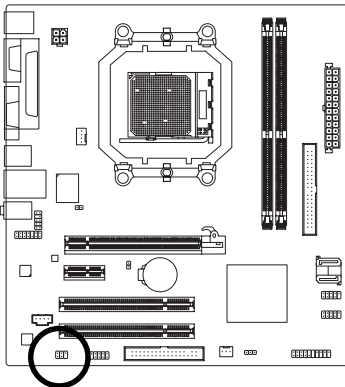

Pin No.	Definition
1	Power
2	No Pin
3	SPDIF
4	SPDIFI
5	GND
6	GND

13) HDA_SUR (Surround Center Connector)

Attach the connector of the 5.1/7.1 Surround Cable (optional) to this connector.

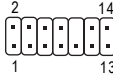
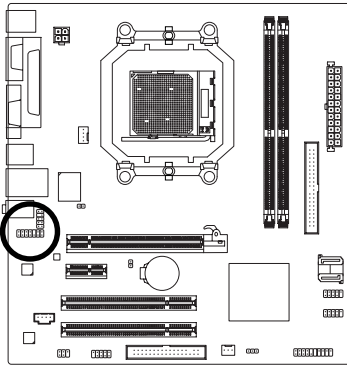

Pin No.	Definition
1	LEF_P
2	SURR_RR
3	CEN_P
4	SURR_LL
5	CEN_JD
6	SURR_JD
7	GND
8	-SUR_DET
9	GND
10	No Pin
11	GND
12	S_SURR_JD
13	S_SURR_LL
14	S_SURR_RR

14) F_USB1 / F_USB2 / (Front USB Connectors)

Be careful with the polarity of the front USB connector. Check the pin assignment carefully while you connect the front USB cable, incorrect connection between the cable and connector will make the device unable to work or even damage it. For optional front USB cable, please contact your local dealer.

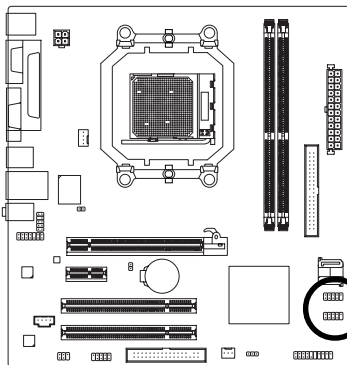

Pin No.	Definition
1	Power (5V)
2	Power (5V)
3	USB DX-
4	USB Dy-
5	USB DX+
6	USB Dy+
7	GND
8	GND
9	No Pin
10	NC

15) COMB (COMB Connector)

Be careful with the polarity of the COMB connector. Check the pin assignments while you connect the COMB cable. Please contact your nearest dealer for optional COMB cable.

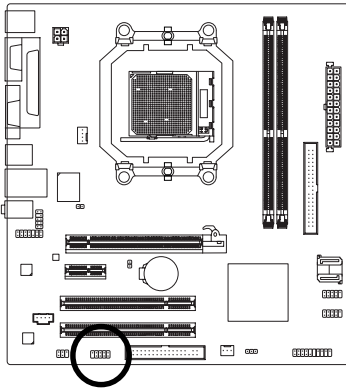

Pin No.	Definition
1	NDCDB-
2	NSINB
3	NSOUTB
4	NDTRB-
5	GND
6	NDSRB-
7	NRTSB-
8	NCTSB-
9	NRIB-
10	No Pin

16) CI (Chassis Intrusion, Case Open)

This 2-pin connector allows your system to detect if the chassis cover is removed. You can check the "Case Opened" status in BIOS Setup.

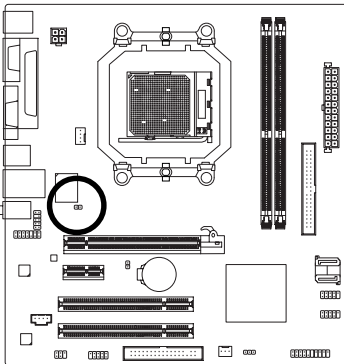

Pin No.	Definition
1	Signal
2	GND

17) CLR_CMOS (Clear CMOS)

You may clear the CMOS data to its default values by this header. To clear CMOS, temporarily short the two pins. Default doesn't include the jumper to avoid improper use of this header.

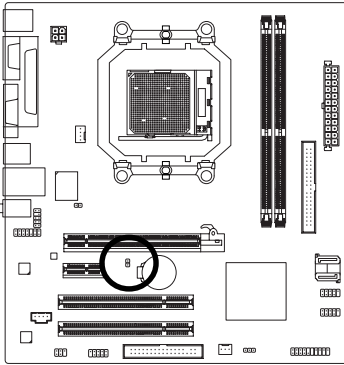

 Open: Normal

 Short: Clear CMOS

18) BATTERY

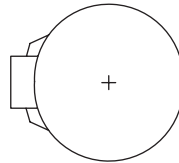
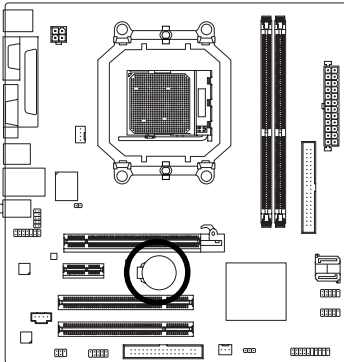

- ❖ Danger of explosion if battery is incorrectly replaced.
- ❖ Replace only with the same or equivalent type recommended by the manufacturer.
- ❖ Dispose of used batteries according to the manufacturer's instructions.

If you want to erase CMOS...

1. Turn off the computer and unplug the power cord.
2. Gently take out the battery and put it aside for about one minute.
(Or you can use a metal object to connect the positive and negative pins in the battery holder to make them short for five seconds.)
3. Re-install the battery.
4. Plug the power cord in and turn on the computer.

Chapter 2 BIOS Setup

BIOS (Basic Input and Output System) includes a CMOS SETUP utility which allows user to configure required settings or to activate certain system features.

The CMOS SETUP saves the configuration in the CMOS SRAM of the motherboard.

When the power is turned off, the battery on the motherboard supplies the necessary power to the CMOS SRAM.

When the power is turned on, pressing the button during the BIOS POST (Power-On Self Test) will take you to the CMOS SETUP screen. You can enter the BIOS setup screen by pressing "Ctrl + F1".

If you wish to upgrade to a new BIOS, either Gigabyte's Q-Flash or @BIOS utility can be used.

Q-Flash allows the user to quickly and easily update or backup BIOS without entering the operating system.

@BIOS is a Windows-based utility that does not require users to boot to DOS before upgrading BIOS but directly download and update BIOS from the Internet.

CONTROL KEYS

<↑> <↓> <←> <→>	Move to select item
<Enter>	Select Item
<Esc>	Main Menu - Quit and not save changes into CMOS Status Page Setup Menu and Option Page Setup Menu - Exit current page and return to Main Menu
<Page Up>	Increase the numeric value or make changes
<Page Down>	Decrease the numeric value or make changes
<F1>	General help, only for Status Page Setup Menu and Option Page Setup Menu
<F2>	Item Help
<F5>	Restore the previous CMOS value from CMOS, only for Option Page Setup Menu
<F6>	Load the fail-safe default CMOS value from BIOS default table
<F7>	Load the Optimized Defaults
<F8>	Q-Flash utility
<F9>	System Information
<F10>	Save all the CMOS changes, only for Main Menu

Main Menu

The on-line description of the highlighted setup function is displayed at the bottom of the screen.

Status Page Setup Menu / Option Page Setup Menu

Press <F1> to pop up a small help window that describes the appropriate keys to use and the possible selections for the highlighted item. To exit the Help Window press <Esc>.



Because BIOS flashing is potentially risky, please do it with caution and avoid inadequate operation that may result in system malfunction.

<F12> : Boot Menu

Select boot sequence for onboard (or add-on cards) device.

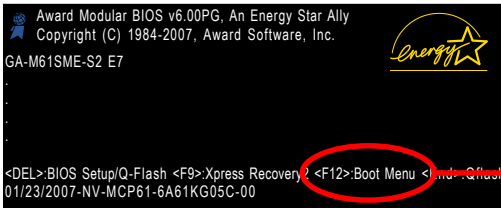

<F12>:Boot Menu

Use <↑> or <↓> to select a device, then press enter to accept . Press <ESC> to exit this menu.

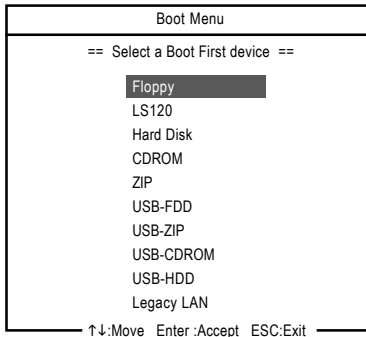

The Main Menu (For example: BIOS Ver. : E7)

Once you enter Award BIOS CMOS Setup Utility, the Main Menu (as figure below) will appear on the screen. Use arrow keys to select among the items and press <Enter> to accept or enter the sub-menu.

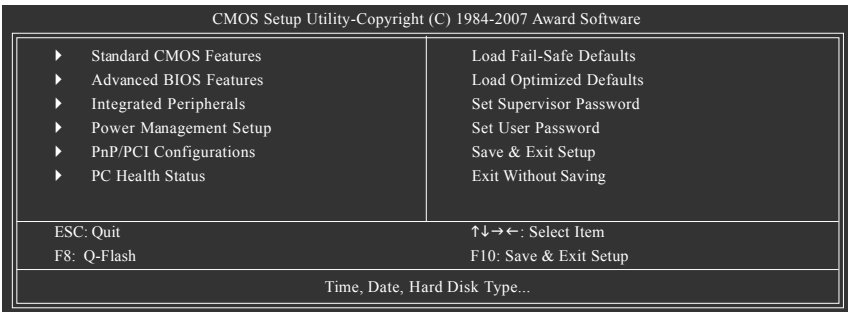

NOTE

1. If you don't find the settings you want, press "Ctrl+F1" to access advanced options.
2. Select the **Load Optimized Defaults** item in the BIOS Setup when somehow the system is not stable as usual. This action makes the system reset to the default settings for stability.
3. The BIOS Setup menus described in this chapter are for reference only and may differ from the exact settings for your motherboard.

■ **Standard CMOS Features**

This setup page includes all the items in standard compatible BIOS.

■ **Advanced BIOS Features**

This setup page includes all the items of Award special enhanced features.

■ **Integrated Peripherals**

This setup page includes all onboard peripherals.

■ **Power Management Setup**

This setup page includes all the items of Green function features.

■ **PnP/PCI Configuration**

This setup page includes all the configurations of PCI & PnP ISA resources.

■ **PC Health Status**

This setup page is the System auto detect Temperature, voltage, fan, speed.

■ **Load Fail-Safe Defaults**

Fail-Safe Defaults indicates the value of the system parameters which the system would be in safe configuration.

■ **Load Optimized Defaults**

Optimized Defaults indicates the value of the system parameters which the system would be in best performance configuration.

■ **Set Supervisor Password**

Change, set, or disable password. It allows you to limit access to the system and Setup, or just to Setup.

■ **Set User Password**

Change, set, or disable password. It allows you to limit access to the system.

■ **Save & Exit Setup**

Save CMOS value settings to CMOS and exit setup.

■ **Exit Without Saving**

Abandon all CMOS value changes and exit setup.

2-1 Standard CMOS Features

CMOS Setup Utility-Copyright (C) 1984-2007 Award Software Standard CMOS Features		
Date (mm:dd:yy)	Mon, Mar 5 2007	Item Help
Time (hh:mm:ss)	14:42:37	Menu Level▶
▶ IDE Channel 0 Master	[None]	
▶ IDE Channel 0 Slave	[None]	
▶ IDE Channel 2 Master	[None]	
▶ IDE Channel 3 Master	[None]	
Drive A	[1.44M, 3.5"]	
Floppy 3 Mode Support	[Disabled]	
Halt On	[All, But Keyboard]	
Base Memory	640K	
Extended Memory	511M	
↑↓→←: Move Enter: Select +/-/PU/PD: Value F10: Save ESC: Exit F1: General Help F5: Previous Values F6: Fail-Safe Defaults F7: Optimized Defaults		

☞ Date

The date format is <week>, <month>, <day>, <year>.

- ▶▶ Week The week, from Sun to Sat, determined by the BIOS and is display-only
- ▶▶ Month The month, Jan. Through Dec.
- ▶▶ Day The day, from 1 to 31 (or the maximum allowed in the month)
- ▶▶ Year The year, from 2000 through 2099

☞ Time

The times format in <hour> <minute> <second>. The time is calculated base on the 24-hour military-time clock. For example, 1 p.m. is 13:0:0.

☞ IDE Channel 0 Master, Slave

- ▶▶ IDE HDD Auto-Detection Press "Enter" to select this option for automatic device detection.
- ▶▶ IDE Device Setup. You can use one of three methods:
 - Auto Allows BIOS to automatically detect IDE/SATA devices during POST(default)
 - None Select this if no IDE/SATA devices are used and the system will skip the automatic detection step and allow for faster system start up.
 - Manual User can manually input the correct settings
- ▶▶ Access Mode Use this to set the access mode for the hard drive. The four options are: CHS/LBA/Large/Auto(default:Auto)

☞ IDE Channel 2/3 Master

- ▶▶ IDE Auto-Detection
Press "Enter" to select this option for automatic device detection.
- ▶▶ Extended IDE Drive. IDE/SATA Device Setup. You can use one of the two methods:
 - Auto Allows BIOS to automatically detect IDE/SATA devices during POST(default)
 - None Select this if no IDE/SATA devices are used and the system will skip the automatic detection step and allow for faster system start up.

- ▶▶ Access Mode Use this to set the access mode for the hard drive. The two options are:
Large/Auto(default: Auto)
- ▶▶ Capacity Capacity of currently installed hard disk.
Hard drive information should be labeled on the outside drive casing. Enter the appropriate option based on this information.
- ▶▶ Cylinder Number of cylinders
- ▶▶ Head Number of heads
- ▶▶ Precomp Write precomp
- ▶▶ Landing Zone Landing zone
- ▶▶ Sector Number of sectors

☞ Drive A

The category identifies the types of floppy disk drive A that has been installed in the computer.

- ▶▶ None No floppy drive installed
- ▶▶ 360K, 5.25" 5.25 inch PC-type standard drive; 360 K byte capacity.
- ▶▶ 1.2M, 5.25" 5.25 inch AT-type high-density drive; 1.2 M byte capacity
(3.5 inch when 3 Mode is Enabled).
- ▶▶ 720K, 3.5" 3.5 inch double-sided drive; 720 K byte capacity
- ▶▶ 1.44M, 3.5" 3.5 inch double-sided drive; 1.44 M byte capacity. (Default value)
- ▶▶ 2.88M, 3.5" 3.5 inch double-sided drive; 2.88 M byte capacity.

☞ Floppy 3 Mode Support (for Japan Area)

- ▶▶ Disabled Normal Floppy Drive. (Default value)
- ▶▶ Drive A Drive A is 3 mode Floppy Drive.

☞ Halt on

The category determines whether the computer will stop if an error is detected during power up.

- ▶▶ No Errors The system boot will not stop for any error that may be detected and you will be prompted.
- ▶▶ All Errors Whenever the BIOS detects a non-fatal error the system will be stopped.
- ▶▶ All, But Keyboard The system boot will not stop for a keyboard error; it will stop for all other errors. (Default value)
- ▶▶ All, But Diskette The system boot will not stop for a disk error; it will stop for all other errors.
- ▶▶ All, But Disk/Key The system boot will not stop for a keyboard or disk error; it will stop for all other errors.

☞ Memory

The category is display-only which is determined by POST (Power On Self Test) of the BIOS.

▶▶ Base Memory

The POST of the BIOS will determine the amount of base (or conventional) memory installed in the system.

The value of the base memory is typically 512 K for systems with 512 K memory installed on the motherboard, or 640 K for systems with 640 K or more memory installed on the motherboard.

▶▶ Extended Memory

The BIOS determines how much extended memory is present during the POST.

This is the amount of memory located above 1 MB in the CPU's memory address map.

2-2 Advanced BIOS Features

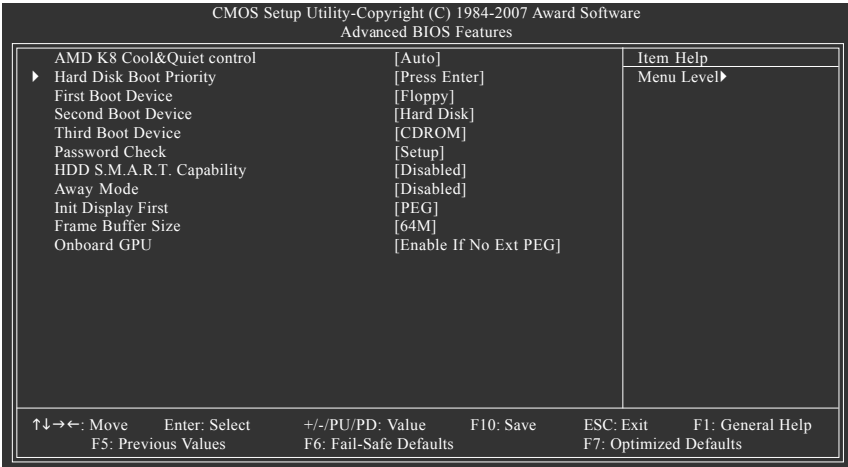

AMD K8 Cool&Quiet control

- ▶ Auto AMD Cool&Quiet driver manages clock and VID to best serve the thermal, performance and power requirements. (Default value)
- ▶ Disabled Disable this function.

Hard Disk Boot Priority

Select boot sequence for onboard(or add-on cards) SCSI, RAID, etc.

Use <↑> or <↓> to select a device, then press<+> to move it up, or <-> to move it down the list. Press <ESC> to exit this menu.

First / Second / Third Boot Device

- ▶ Floppy Select your boot device priority by Floppy.
- ▶ LS120 Select your boot device priority by LS120.
- ▶ Hard Disk Select your boot device priority by Hard Disk.
- ▶ CDROM Select your boot device priority by CDROM.
- ▶ ZIP Select your boot device priority by ZIP.
- ▶ USB-FDD Select your boot device priority by USB-FDD.
- ▶ USB-ZIP Select your boot device priority by USB-ZIP.
- ▶ USB-CDROM Select your boot device priority by USB-CDROM.
- ▶ USB-HDD Select your boot device priority by USB-HDD.
- ▶ Legacy LAN Select your boot device priority by Legacy LAN.
- ▶ Disabled Disable this function.

Password Check

- ▶ System The system can not boot and can not access to Setup page will be denied if the correct password is not entered at the prompt.
- ▶ Setup The system will boot, but access to Setup will be denied if the correct password is not entered at the prompt. (Default value)

☞ **HDD S.M.A.R.T. Capability**

This feature allows your hard disk to report read/write errors and to issue warnings when third-party hardware monitor utility is installed.

- ▶▶ Enabled Enable HDD S.M.A.R.T. capability.
- ▶▶ Disabled Disable HDD S.M.A.R.T. capability. (Default value)

☞ **Away Mode**

- ▶▶ Disabled Disable this function. (Default value)
- ▶▶ Enabled Enable Away Mode in Windows XP Media Center operating system.
(Away Mode: Enables the system to silently perform unattended tasks while in a low-power mode that appears off.)

☞ **Init Display First**

This feature allows you to select the first initiation of the monitor display from which card when you install a PCI card and a PCI Express VGA card on the motherboard.

- ▶▶ PCI Slot Set Init display first to PCI.
- ▶▶ PEG Set Init display first to PCI Express VGA card. (Default value)
- ▶▶ Onboard VGA Set Init display first to Onboard VGA.

☞ **Frame Buffer Size**

- ▶▶ 32M Set frame buffer size to 32 M.
- ▶▶ 64M Set frame buffer size to 64 M. (Default value)
- ▶▶ 128M Set frame buffer size to 128 M.
- ▶▶ 256M Set frame buffer size to 256 M.
- ▶▶ Disabled Disable this function.

☞ **Onboard GPU**

This item allows the user to decide when to activate the onboard VGA function.

- ▶▶ Enable If No Ext PEG
Activate the onboard VGA only when no PCI Express VGA card is installed. (Default value)
- ▶▶ Always Enable

Always activate the onboard VGA, whether or not a PCI Express card is installed. If you wish to set up a dual view configuration, set this item to **Always Enable**.

2-3 Integrated Peripherals

CMOS Setup Utility-Copyright (C) 1984-2007 Award Software
Integrated Peripherals

<ul style="list-style-type: none"> ▶ Serial-ATA RAID Config On-Chip IDE Channel0 On-Chip MAC Lan NV Serial-ATA 1 IDE Prefetch Mode USB Memory Type Onboard Audio Function Onboard LAN Boot ROM Onboard Serial Port 1 Onboard Serial Port 2 Onboard Parallel Port Parallel Port Mode x ECP Mode Use DMA On-Chip USB USB Keyboard Support USB Mouse Support Legacy USB Storage detect 	<ul style="list-style-type: none"> [Press Enter] [Enabled] [Auto] [Enabled] [Enabled] [SHADOW] [Auto] [Disabled] [3F8/IRQ4] [2F8/IRQ3] [378/IRQ7] [SPP] 3 [V1.1+V2.0] [Disabled] [Disabled] [Enabled] 	<ul style="list-style-type: none"> Item Help Menu Level▶
<p>↑↓→←: Move Enter: Select +/-/PU/PD: Value F10: Save ESC: Exit F1: General Help F5: Previous Values F6: Fail-Safe Defaults F7: Optimized Defaults</p>		

Serial-ATA RAID Config

CMOS Setup Utility-Copyright (C) 1984-2007 Award Software
Serial-ATA RAID Config

<ul style="list-style-type: none"> NV SATA RAID function x NV SATA 1 Primary RAID x NV SATA 1 Secondary RAID 	<ul style="list-style-type: none"> [Disabled] Enabled Enabled 	<ul style="list-style-type: none"> Item Help Menu Level▶
<p>↑↓→←: Move Enter: Select +/-/PU/PD: Value F10: Save ESC: Exit F1: General Help F5: Previous Values F6: Fail-Safe Defaults F7: Optimized Defaults</p>		

- ☞ **NV SATA RAID function**
 - ▶▶ Enabled Enable NV SATA RAID function.
 - ▶▶ Disabled Disable NV SATA RAID function. (Default value)
- ☞ **NV SATA 1 Primary RAID**
 - ▶▶ Enabled Enable NV SATA 1 primary RAID function.
 - ▶▶ Disabled Disable this function. (Default value)
- ☞ **NV SATA 1 Secondary RAID**
 - ▶▶ Enabled Enable NV SATA 1 secondary RAID function.
 - ▶▶ Disabled Disable this function. (Default value)
- ☞ **On-Chip IDE Channel0**
 - ▶▶ Enabled Enable onboard 1st channel IDE port. (Default value)
 - ▶▶ Disabled Disable onboard 1st channel IDE port.
- ☞ **On-Chip MAC Lan**
 - ▶▶ Auto Auto-detect onboard LAN chip function. (Default value)
 - ▶▶ Disabled Disable onboard LAN chip function.
- ☞ **NV Serial-ATA 1**
 - ▶▶ Enabled Enable NV Serial-ATA 1 function. (Default value)
 - ▶▶ Disabled Disable this function.
- ☞ **IDE Prefetch Mode**
 - ▶▶ Enabled Enable IDE data buffer to enhance HDD transfer speed. (Default value)
 - ▶▶ Disabled Disable IDE data buffer for the system stability.
- ☞ **USB Memory Type**
 - ▶▶ SHADOW Set USB memory type to SHADOW. (Default value)
 - ▶▶ Base Memory(640K) Set USB memory type to base memory(640 K).
- ☞ **Onboard Audio Function**
 - ▶▶ Auto Auto-detect onboard audio function. (Default value)
 - ▶▶ Disabled Disable this function.
- ☞ **Onboard LAN Boot ROM**

This function decide whether to invoke the boot ROM of the onboard LAN chip.

 - ▶▶ Enabled Enable this function.
 - ▶▶ Disabled Disable this function. (Default value)
- ☞ **Onboard Serial Port 1**
 - ▶▶ Auto BIOS will automatically setup the Serial port 1 address.
 - ▶▶ 3F8/IRQ4 Enable onboard Serial port 1 and address is 3F8/IRQ4. (Default value)
 - ▶▶ 2F8/IRQ3 Enable onboard Serial port 1 and address is 2F8/IRQ3.
 - ▶▶ 3E8/IRQ4 Enable onboard Serial port 1 and address is 3E8/IRQ4.
 - ▶▶ 2E8/IRQ3 Enable onboard Serial port 1 and address is 2E8/IRQ3.
 - ▶▶ Disabled Disable onboard Serial port 1.

☞ Onboard Serial Port 2

- ▶▶ Auto BIOS will automatically setup the port 2 address.
- ▶▶ 3F8/IRQ4 Enable onboard Serial port 2 and address is 3F8/IRQ4.
- ▶▶ 2F8/IRQ3 Enable onboard Serial port 2 and address is 2F8/IRQ3. (Default value)
- ▶▶ 3E8/IRQ4 Enable onboard Serial port 2 and address is 3E8/IRQ4.
- ▶▶ 2E8/IRQ3 Enable onboard Serial port 2 and address is 2E8/IRQ3.
- ▶▶ Disabled Disable onboard Serial port 2.

☞ Onboard Parallel Port

- ▶▶ Disabled Disable onboard LPT port.
- ▶▶ 378/IRQ7 Enable onboard LPT port and address is 378/IRQ7. (Default value)
- ▶▶ 278/IRQ5 Enable onboard LPT port and address is 278/IRQ5.
- ▶▶ 3BC/IRQ7 Enable onboard LPT port and address is 3BC/IRQ7.

☞ Parallel Port Mode

- ▶▶ SPP Using Parallel port as Standard Parallel Port. (Default value)
- ▶▶ EPP Using Parallel port as Enhanced Parallel Port.
- ▶▶ ECP Using Parallel port as Extended Capabilities Port.
- ▶▶ ECP+EPP Using Parallel port as ECP and EPP mode.

☞ ECP Mode Use DMA

- ▶▶ 3 Set ECP Mode Use DMA to 3. (Default value)
- ▶▶ 1 Set ECP Mode Use DMA to 1.

☞ On-Chip USB

- ▶▶ Disabled Disable this function if you are not using onboard USB function.
- ▶▶ V1.1+V2.0 Enable USB 1.1 and USB 2.0 controller. (Default value)
- ▶▶ V1.1 Enable only USB 1.1 controller.

☞ USB Keyboard Support

- ▶▶ Enabled Enable USB keyboard support.
- ▶▶ Disabled Disable USB keyboard support. (Default value)

☞ USB Mouse Support

- ▶▶ Enabled Enable USB mouse support.
- ▶▶ Disabled Disable USB mouse support. (Default value)

☞ Legacy USB Storage detect

This option allows users to decide whether to detect USB storage devices, including USB flash drives and USB hard drives during POST.

- ▶▶ Enabled BIOS will scan all USB storage devices. (Default value)
- ▶▶ Disabled Disable this function.

2-4 Power Management Setup

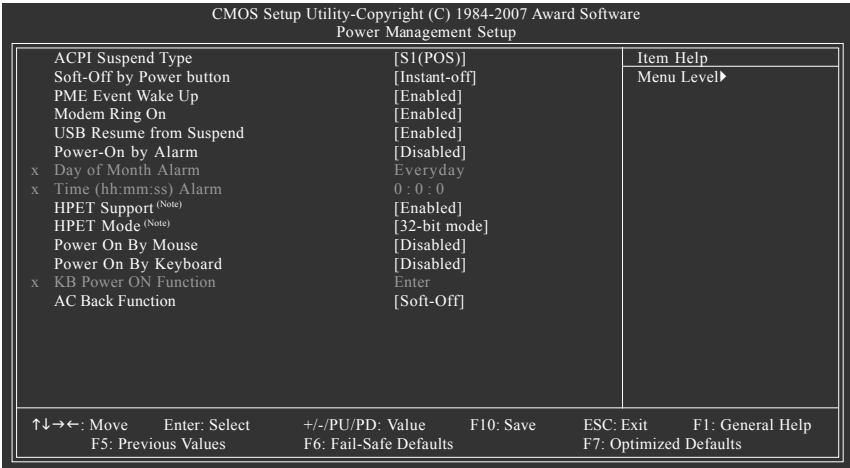

☞ ACPI Suspend Type

- ▶▶ S1(POS) Set ACPI suspend type to S1/POS(Power On Suspend). (Default value)
- ▶▶ S3(STR) Set ACPI suspend type to S3/STR(Suspend To RAM).

☞ Soft-Off by Power button

- ▶▶ Instant-off Press power button then Power off instantly. (Default value)
- ▶▶ Delay 4 Sec Press power button 4 seconds to Power off. Enter suspend if button is pressed less than 4 seconds.

☞ PME Event Wake Up

This feature requires an ATX power supply that provides at least 1A on the 5VSB lead.

- ▶▶ Disabled Disable this function.
- ▶▶ Enabled Enable PME as wake up event. (Default value)

☞ Modem Ring On

An incoming call via modem can awake the system from any suspend state.

- ▶▶ Disabled Disable Modem Ring on function.
- ▶▶ Enabled Enable Modem Ring on function. (Default value)

☞ USB Resume from Suspend

- ▶▶ Disabled Disable this function.
- ▶▶ Enabled Enable USB device wake up system from suspend mode. (Default value)

(Note) Supported on Vista operating system only.

☞ **Power-On by Alarm**

You can enable the "Power-On by Alarm" item and key in Date/Time to power on system.

- ▶▶ Disabled Disable this function. (Default value)
- ▶▶ Enabled Enable alarm function to POWER ON system.

If Power-On by Alarm is Enabled.

- ▶▶ Day of Month Alarm : Everyday, 1~31
- ▶▶ Time (hh: mm: ss) Alarm : (0~23) : (0~59) : (0~59)

☞ **HPET Support** ^(Note)

- ▶▶ Disabled Disable this function.
- ▶▶ Enabled Enable support for High Precision Event Timer (HPET) function. (Default value)

☞ **HPET Mode** ^(Note)

- ▶▶ 32-bit mode Select 32-bit mode for 32-bit Vista operating system. (Default value)
- ▶▶ 64-bit mode Select 64-bit mode for 64-bit Vista operating system.

☞ **Power On By Mouse**

- ▶▶ Disabled Disable this function. (Default value)
- ▶▶ Double Click Double click on PS/2 mouse left button to power on the system.

☞ **Power On By Keyboard**

- ▶▶ Disabled Disable this function. (Default value)
- ▶▶ Password Enter from 1 to 5 characters to set the Keyboard Power On Password.
- ▶▶ Any KEY Press any key to power on the system.
- ▶▶ Keyboard 98 If your keyboard has a "POWER Key" button, you can press the key to power on the system.

☞ **KB Power ON Password**

When "Power On by Keyboard" set at Password, you can set the password here.

- ▶▶ Enter Input password (from 1 to 5 characters) and press Enter to set the Keyboard Power On password.

☞ **AC Back Function**

- ▶▶ Soft-Off When AC-power back to the system, the system will be in "Off" state. (Default value)
- ▶▶ Full-On When AC-power back to the system, the system always in "On" state.

(Note) Supported on Vista operating system only.

2-5 PnP/PCI Configurations

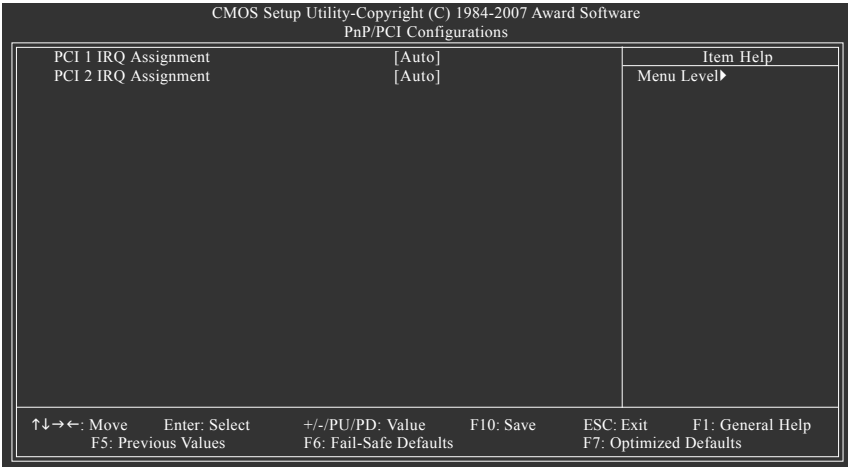

☞ PCI 1 IRQ Assignment

- ▶▶ Auto Auto assign IRQ to PCI 1. (Default value)
- ▶▶ 3,4,5,7,9,10,11,12,14,15 Set IRQ 3,4,5,7,9,10,11,12,14,15 to PCI 1.

☞ PCI 2 IRQ Assignment

- ▶▶ Auto Auto assign IRQ to PCI 2. (Default value)
- ▶▶ 3,4,5,7,9,10,11,12,14,15 Set IRQ 3,4,5,7,9,10,11,12,14,15 to PCI 2.

2-6 PC Health Status

CMOS Setup Utility-Copyright (C) 1984-2007 Award Software		Item Help
PC Health Status		Menu Level▶
Reset Case Open Status	[Disabled]	
Case Opened	Yes	
Vcore	OK	
DDR2 1.8V	OK	
+3.3V	OK	
+12V	OK	
Current System Temperature	25°C	
Current CPU Temperature	40°C	
Current CPU FAN Speed	3183 RPM	
Current SYSTEM FAN Speed	0 RPM	
System Warning Temperature	[Disabled]	
CPU Warning Temperature	[Disabled]	
CPU FAN Fail Warning	[Disabled]	
SYSTEM FAN Fail Warning	[Disabled]	
CPU Smart FAN Control	[Enabled]	
CPU Smart FAN Mode	[Auto]	

↑↓→←: Move	Enter: Select	+/-/PU/PD: Value	F10: Save	ESC: Exit	F1: General Help
F5: Previous Values		F6: Fail-Safe Defaults		F7: Optimized Defaults	

Reset Case Open Status

- ▶▶ Disabled Don't reset case open status. (Default value)
- ▶▶ Enabled Clear case open status at next boot.

Case Opened

If the case is closed, "Case Opened" will show "No".

If the case have been opened, "Case Opened" will show "Yes".

If you want to reset "Case Opened" value, set "Reset Case Open Status" to "Enabled" and save CMOS, your computer will restart.

Current Voltage(V) Vcore/DDR2 1.8V/+3.3V/+12V

- ▶▶ Detect system's voltage status automatically.

Current System/CPU Temperature

- ▶▶ Detect system/CPU temperature automatically.

Current CPU/SYSTEM FAN Speed (RPM)

- ▶▶ Detect CPU/system fan speed status automatically.

System/CPU Warning Temperature

- ▶▶ 60°C / 140°F Monitor system/CPU temperature at 60°C / 140°F.
- ▶▶ 70°C / 158°F Monitor system/CPU temperature at 70°C / 158°F.
- ▶▶ 80°C / 176°F Monitor system/CPU temperature at 80°C / 176°F.
- ▶▶ 90°C / 194°F Monitor system/CPU temperature at 90°C / 194°F.
- ▶▶ Disabled Disable this function. (Default value)

CPU/SYSTEM FAN Fail Warning

- ▶▶ Disabled Disable the CPU/system fan fail warning function. (Default value)
- ▶▶ Enabled Enable the CPU/system fan fail warning function.

☞ **CPU Smart FAN Control**^(Note)

- ▶ Disabled Disable this function.
- ▶ Enabled When this function is enabled, CPU fan will run at different speed depending on CPU temperature. Users can adjust the fan speed with Easy Tune based on their requirements. (Default value)

☞ **CPU Smart FAN Mode**

This option is available only when CPU Smart FAN Control is enabled.

- ▶ Auto BIOS autodetects the type of CPU fan you installed and sets the optimal CPU Smart FAN control mode for it. (Default value)
- ▶ Voltage Set to Voltage when you use a CPU fan with a 3-pin fan power cable.
- ▶ PWM Set to PWM when you use a CPU fan with a 4-pin fan power cable.

(Note) Whether the CPU Smart FAN Control function is supported will depend on the CPU you install.

2-7 Load Fail-Safe Defaults

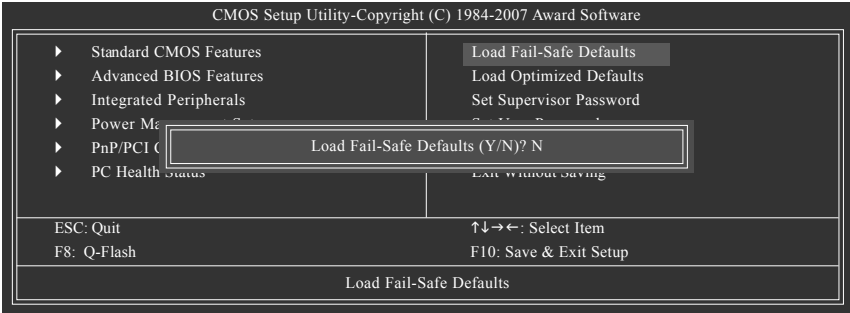

Fail-Safe defaults contain the most appropriate values of the system parameters that allow minimum system performance.

2-8 Load Optimized Defaults

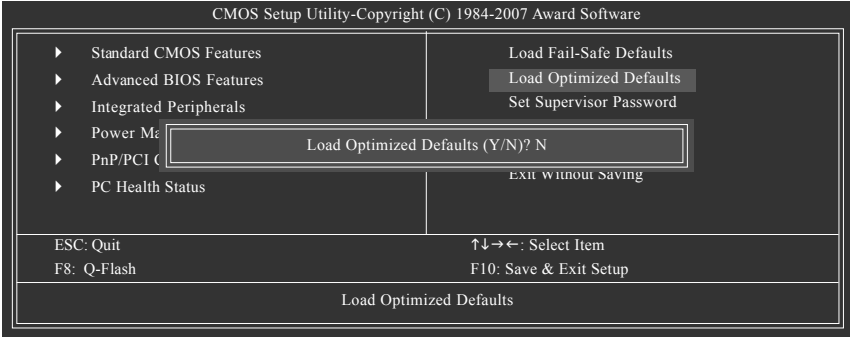

Selecting this field loads the factory defaults for BIOS and Chipset Features which the system automatically detects.

2-9 Set Supervisor/User Password

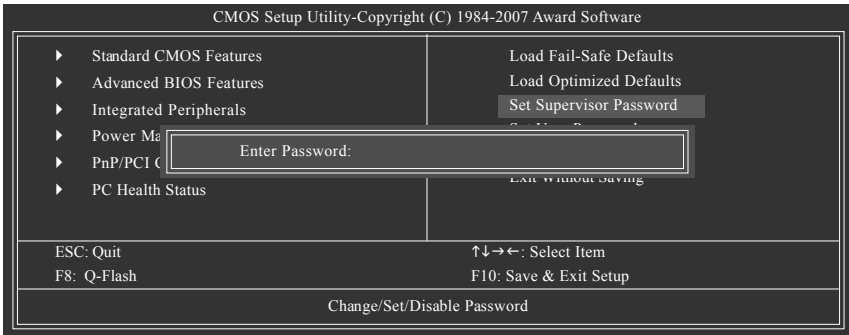

When you select this function, the following message will appear at the center of the screen to assist you in creating a password.

Type the password, up to eight characters, and press <Enter>. You will be asked to confirm the password. Type the password again and press <Enter>. You may also press <Esc> to abort the selection and not enter a password.

To disable password, just press <Enter> when you are prompted to enter password. A message "PASSWORD DISABLED" will appear to confirm the password being disabled. Once the password is disabled, the system will boot and you can enter Setup freely.

The BIOS Setup program allows you to specify two separate passwords:

SUPERVISOR PASSWORD and a USER PASSWORD. When disabled, anyone may access all BIOS Setup program function. When enabled, the Supervisor password is required for entering the BIOS Setup program and having full configuration fields, the User password is required to access only basic items.

If you select "System" at "Password Check" in Advance BIOS Features Menu, you will be prompted for the password every time the system is rebooted or any time you try to enter Setup Menu.

If you select "Setup" at "Password Check" in Advance BIOS Features Menu, you will be prompted only when you try to enter Setup.

2-10 Save & Exit Setup

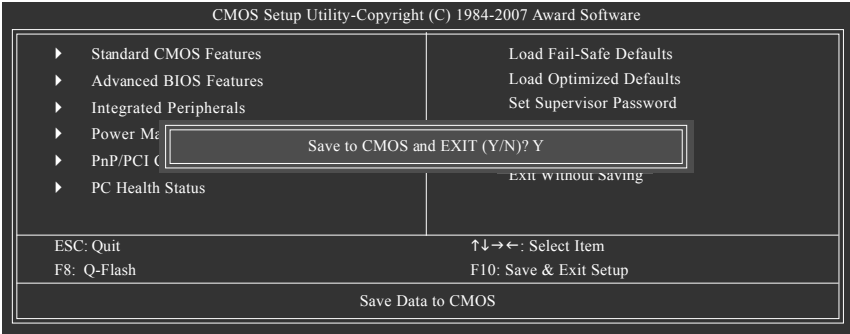

Type "Y" will quit the Setup Utility and save the user setup value to RTC CMOS.
Type "N" will return to Setup Utility.

2-11 Exit Without Saving

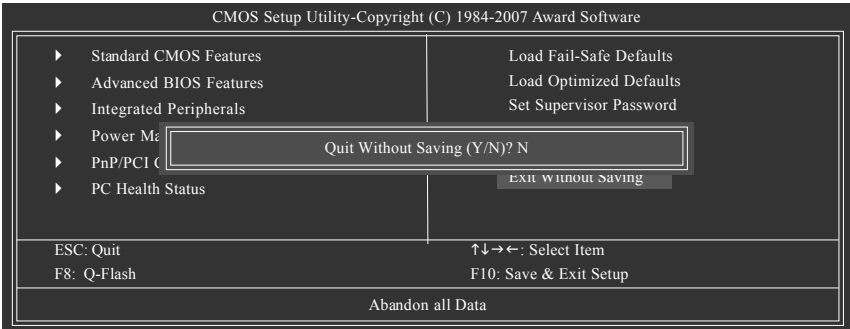

Type "Y" will quit the Setup Utility without saving to RTC CMOS.
Type "N" will return to Setup Utility.

Chapter 3 Drivers Installation



For Windows XP/2000 operating system, please install the NVIDIA® GeForce™ 6100/nForce™ Series Utility CD.

For Windows Vista operating system, please install the NVIDIA® Series Vista Utility CD. Pictures below are shown in Windows XP.

Insert the driver CD-title that came with your motherboard into your CD-ROM drive, the driver CD-title will auto start and show the installation guide. If not, please double click the CD-ROM device icon in "My computer", and execute the Run.exe.

3-1 Install Chipset Drivers

"Xpress Install " is now analyzing your computer...99%

After insert the driver CD, "Xpress Install" will scan automatically the system and then list all the drivers that recommended to install. Please pick the item that you want and press "install" followed the item; or you can press "Xpress Install" to install all items defaulted.



The "Xpress Install" uses the "Click and Go" technology to install the drivers automatically. Just select the drivers you want then click the "Go" button. The "Xpress Install" will execute the installation for you automatically.



Some device drivers will restart your system automatically. After restarting your system the "Xpress Install" will continue to install other drivers.

System will reboot automatically after install the drivers, afterward you can install others application.



CAUTION

For USB2.0 driver support under Windows XP operating system, please use Windows Service Pack. After install Windows Service Pack, it will show a question mark "?" in "Universal Serial Bus controller" under "Device Manager". Please remove the question mark and restart the system (System will auto-detect the right USB2.0 driver).

3-2 Software Applications

This page displays all the tools that Gigabyte developed and some free software, you can choose anyone you want and press "install" to install them.



3-3 Driver CD Information

This page lists the contents of software and drivers in this CD-title.

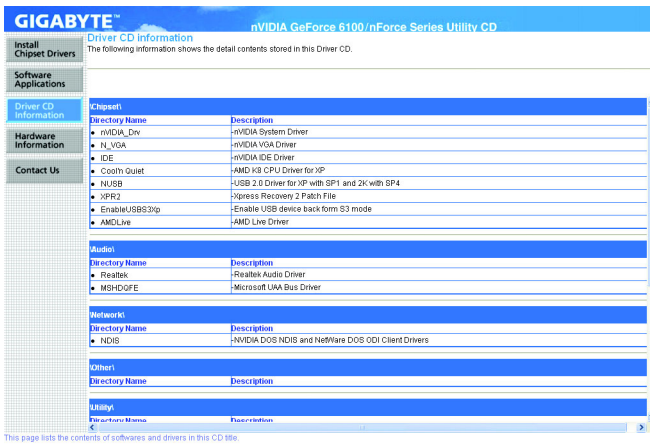

3-4 Hardware Information

This page lists all device you have for this motherboard.

The screenshot displays the 'Hardware Information' section of the nVIDIA GeForce 6100/nForce Series Utility CD. The interface includes a sidebar with navigation options: 'Install Chipset Drivers', 'Software Applications', 'Driver CD Information', 'Hardware Information', and 'Contact Us'. The 'Hardware Information' section is expanded, showing a tree view with 'System Info' selected. Under 'System Info', the following details are listed:

- BIOS Info: MSI/MSME-S2 ER
- CPU Info: CPU: AMD (AuthenticAMD)
- Memory Info: 4GB 5200 KB RAM

Below the system info, there is a 'System' section with a list of installed devices, each with a 'Device Description' and a 'Driver Provider'. The devices listed include:

- Device Description: PCI standard host CPU bridge; Driver Provider: Microsoft
- Device Description: PCI standard host CPU bridge; Driver Provider: Microsoft
- Device Description: PCI standard host CPU bridge; Driver Provider: Microsoft
- Device Description: PCI standard host CPU bridge; Driver Provider: Microsoft
- Device Description: PCI standard host CPU bridge; Driver Provider: Microsoft
- Device Description: PCI standard ISA bridge; Driver Provider: Microsoft
- Device Description: PCI standard RAM Controller; Driver Provider: Microsoft
- Device Description: PCI standard PCI-to-PCI bridge; Driver Provider: Microsoft
- Device Description: PCI standard RAM Controller

At the bottom of the window, a note states: 'This page lists all devices you have for this motherboard.'

3-5 Contact Us

Please see the last page for details.

The screenshot displays the 'Contact Us' section of the nVIDIA GeForce 6100/nForce Series Utility CD. The interface includes a sidebar with navigation options: 'Install Chipset Drivers', 'Software Applications', 'Driver CD Information', 'Hardware Information', and 'Contact Us'. The 'Contact Us' section is expanded, showing a globe graphic and contact information for various regions:

- U.S.A.**
 - GIGABYTE TECHNOLOGY CO., LTD.
1023 New Chung Road, 3rd Floor, Taipei, Taiwan
Tel: +886-2-8912-4000
Fax: +886-2-8912-4003
 - U.S.A. G.B.T. INC.
Tel: +1 (800) 454-9339
Fax: +1 (202) 454-9339
http://www.gigabyte.com
- U.K.**
 - G.B.T. TECH. CO., LTD.
Tel: +44 (0) 1908-562700
Fax: +44 (0) 1908-562008
- Germany**
 - G.B.T. TECHNOLOGY TRADING GMBH
Tel: +49 (0) 62550940 (China)
+49 (0) 623460 (Taiwan)
Fax: +49 (0) 62550935 (China)
+49 (0) 623462 (Taiwan)
- The Netherlands**
 - GIGABYTE TECHNOLOGY B.V.
Tel: +31 (0) 296-2099
N. Netherlands: 0900-0044976 (9900-44423683)
SE Tech Support: 0900-004024
Fax: +31 (0) 296-2099
- Japan**
 - NEPCO GIGABYTE CORP. (ORACLE)
Tel: +81-3-5781-5430
Fax: +81-3-5781-5434
http://www.gigabyte.co.jp
- China (Office)**
 - Shanghai: +86-21-6341-0588; Fax: +86-21-6341-1933
 - Beijing: +86-10-62998851; Fax: +86-10-62998913
 - Shenzhen: +86-755-95709076; Fax: +86-755-95611763
 - Hangzhou: +86-571-87332830; Fax: +86-571-87332822

At the bottom, a note states: 'Contact us via the headquarter or branch offices around the world.'

Chapter 4 Appendix

4-1 Unique Software Utilities

(Not all model support these Unique Software Utilities, please check your MB features.)

4-1-1 EasyTune 5 Introduction

EasyTune 5 presents the most convenient Windows based system performance enhancement and manageability utility. Featuring several powerful yet easy to use tools such as 1) Overclocking for enhancing system performance, 2) C.I.A. and M.I.B. for special enhancement for CPU and Memory, 3) Smart-Fan control for managing fan speed control of both CPU cooling fan and North-Bridge Chipset cooling fan, 4) PC health for monitoring system status.^(Note)

User Interface Overview



	Button / Display	Description
1.	Overclocking	Enters the Overclocking setting page
2.	C.I.A. and M.I.B.	Enters the C.I.A. and M.I.B. setting page
3.	Smart-Fan	Enters the Smart-Fan setting page
4.	PC Health	Enters the PC Health setting page
5.	GO	Confirmation and Execution button
6.	"Easy Mode" & "Advance Mode"	Toggles between Easy and Advance Mode
7.	Display screen	Display panel of CPU frequency
8.	Function display LEDs	Shows the current functions status
9.	GIGABYTE Logo	Log on to GIGABYTE website
10.	Help button	Display EasyTune™ 5 Help file
11.	Exit or Minimize button	Quit or Minimize EasyTune™ 5 software

(Note) EasyTune 5 functions may vary depending on different motherboards.

4-1-2 Xpress Recovery2 Introduction



Xpress Recovery2 is designed to provide quick backup and restoration of hard disk data. Supporting Microsoft operating systems including Windows XP/2000/NT/98/Me and DOS, and file systems including FAT16, FAT32, and NTFS, Xpress Recovery2 is able to back up data on hard disks on PATA and SATA IDE controllers. After Xpress Recovery2 is executed from CD-ROM for the first time, it will stay permanent in your hard disk. If you wish to run Xpress Recovery2 later, you can simply press F9 during system bootup to enter Xpress Recovery2 without the CD-ROM.

System requirements:

1. Intel x86 platforms
2. At least 64M bytes of system memory
3. VESA-supported VGA cards

How to use the Xpress Recovery2

Initial access by booting from CD-ROM and subsequent access by pressing the F9 key:

Steps: After entering BIOS Setup, go to **Advanced BIOS Feature** and set to boot from CD-ROM. Save the settings and exit the BIOS Setup. Insert the provided driver CD into your CD-ROM drive. Upon system restart, the message which says "Boot from CD/DVD:" will appear in the bottom left corner of the screen. Press any key to enter Xpress Recovery2.

After the steps above are completed, subsequent access to Xpress Recovery2 can be made by simply pressing the <F9> key during system power-on.

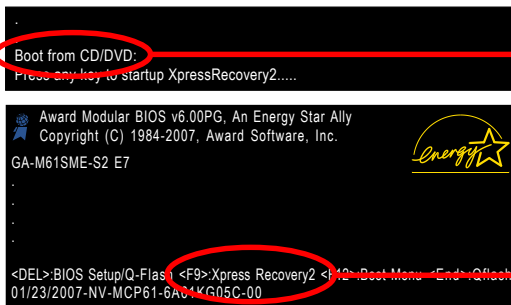

1. If you have already entered Xpress Recovery2 by booting from the CD-ROM, you can enter Xpress Recovery2 by pressing the <F9> key in the future.
2. System storage capacity and the reading/writing speed of the hard disk will affect the data backup speed.
3. It is recommended that Xpress Recovery2 be immediately installed once you complete installations of OS and all required drivers as well as software.

The Main Screen of Xpress Recovery2



1. RESTORE:

Restore the backed-up data to your hard disk.
(This button will not appear if there is no backup file.)

2. BACKUP:

Back up data from hard disk.

3. REMOVE:

Remove previously-created backup files to release disk space.

(This button will not appear if there is no backup file.)

4. REBOOT:

Exit the main screen and restart the system.

Limitations:

1. Not compatible to Xpress Recovery.
2. For the use of Xpress Recovery2, a primary partition must be reserved.
3. Xpress Recovery2 will store the backup file at the end of the hard disk, so free space available on the hard disk for the backup file must be allocated in advance. (A minimum 4GB is recommended but the actual space is dependent on the size of the data to be backed up)
4. Capable of backing up hard disks installed with Windows operating systems including DOS and Windows XP/2000/NT/9x/Me.
5. USB hard disks are currently not supported.
6. Does not support RAID/AHCI (class code 0104/0106) hard disks.
7. Capable of backing up and restoring only the first physical hard disk.

Hard disks detection sequence is as follows:

- a. PATA IDE primary channel
- b. PATA IDE secondary channel
- c. SATA IDE channel 1
- d. SATA IDE channel 2
- e. SATA IDE channel 3
- f. SATA IDE channel 4

Precautions:

1. When using hard disks with more than 128G under Windows 2000, be sure to execute the EnableBigLba.exe program from the driver CD before data backup.
2. It is normal that data backup takes longer time than data restoration.
3. Xpress Recovery2 is compliant with the GPL regulations.
4. On a few motherboards based on Nvidia chipsets, BIOS update is required for Xpress Recovery2 to correctly identify RAID and SATA IDE mode. Please contact your motherboard manufacturer.

4-1-3 Flash BIOS Method Introduction



Method 1 : Q-Flash™

Q-Flash™ is a BIOS update tool that allows the user to update BIOS without entering operating systems like MS-DOS or Windows. Embedded in the BIOS, the Q-Flash™ tool frees you from the hassles of going through complicated BIOS flashing process.

Before Use:

Follow the steps below before using Q-Flash to update BIOS:

1. From GIGABYTE's website, download the latest compressed BIOS update file that matches your motherboard model.
2. Extract the file and save the new BIOS file (e.g. M61SMES2.F1) to your floppy disk, USB flash drive, or hard disk. Note: The USB flash drive or hard disk must use FAT32/16/12 file system.
3. Restart the system. During POST, press the End key to enter Q-Flash. Note: You can access Q-Flash by either pressing the End key during POST or the F8 key in BIOS Setup. However, if the BIOS update file is saved to a hard drive in RAID/AHCI mode or a hard drive attached to an independent IDE/SATA controller, use the End key during POST to access Q-Flash.

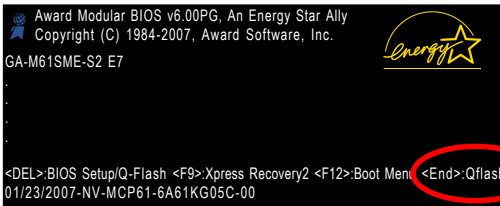

<End> : Qflash



Because BIOS flashing is potentially risky, please do it with caution and avoid inadequate operation that may result in system malfunction.

Updating the BIOS

Step 1:

- a. In the Q-Flash menu, use the UP or DOWN ARROW key to select **Update BIOS from Drive** and press ENTER.



If you wish to back up the current BIOS file, use the **Save BIOS to Drive** function.

- b. Select the floppy drive or hard drive where the BIOS file is saved, such as "Floppy A" and press ENTER.

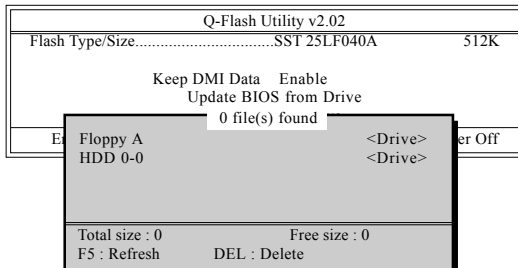

c. Select the BIOS file and press ENTER.



Make sure again the BIOS file matches your motherboard model.

Step 2: The process of system reading the BIOS file from the floppy disk is displayed on the screen. When the message "Are you sure to update BIOS?" appears, press ENTER. The BIOS update will begin and the current process will be displayed.



1. Do not turn off or restart the system when the system is reading/updating the BIOS.
2. Do not remove the floppy disk or hard drive/USB drive when the system is updating the BIOS.

Step 3: When the update process is complete, press any key to return to the Q-Flash main menu.

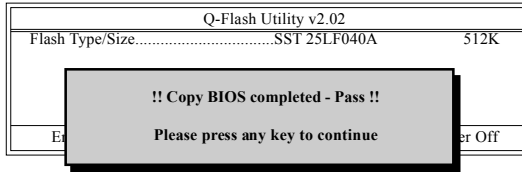

Step 4: Press ESC and then ENTER to exit Q-Flash and the system will restart. As the system reboots, you will see the new BIOS version during POST.

Step 5: As the system reboots, press DELETE to enter BIOS Setup. Select **Load Optimized Defaults** and press ENTER to load BIOS defaults. System will re-detect all peripherals devices after BIOS update, so we recommend that you reload BIOS defaults.

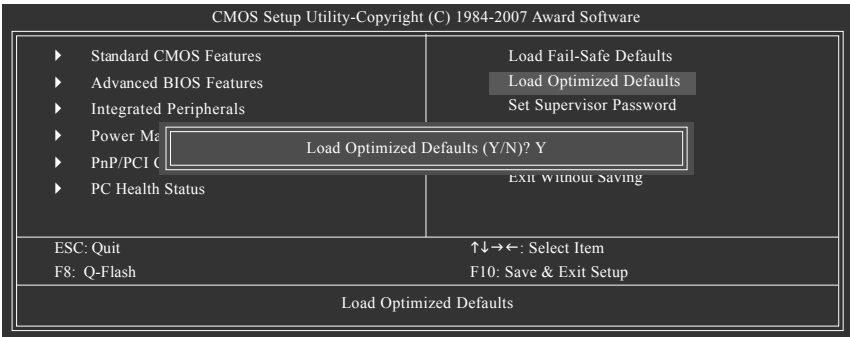

Press Y to load BIOS defaults

Step 6: Select **Save & Exit Setup** and then press Y to save settings to CMOS and exit BIOS Setup. When the system restarts, the whole update process is complete.



Method 2 : @BIOS™ Utility

If you do not have a DOS startup disk, we recommend that you use the new @BIOS utility. @BIOS allows users to update their BIOS under Windows. Just select the desired @BIOS server to download the latest version of BIOS.

Fig 1. Installing the @BIOS utility

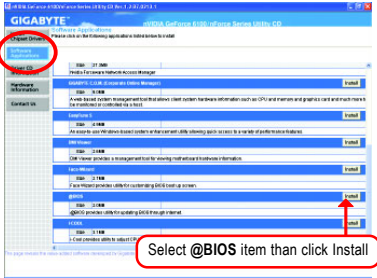

Fig 2. Installation Complete and Run @BIOS

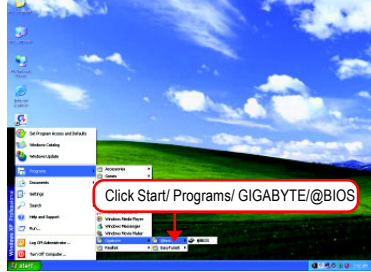

Fig 3. The @BIOS Utility

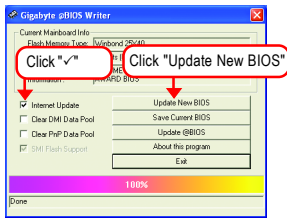
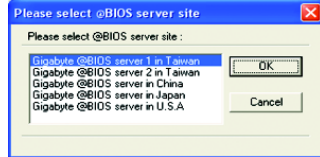

Fig 4. Select the desired @BIOS server



1. Methods and steps:

I. Update BIOS through Internet

- a. Click "Internet Update" icon
- b. Click "Update New BIOS" icon
- c. Select @BIOS™ server
- d. Select the exact model name on your motherboard
- e. System will automatically download and update the BIOS.

II. Update BIOS NOT through Internet:

- a. Do not click "Internet Update" icon
- b. Click "Update New BIOS"
- c. Please select "All Files" in dialog box while opening the old file.
- d. Please search for BIOS unzip file, downloading from internet or any other methods (such as: M61SMES2.F1).
- e. Complete update process following the instruction.

III. Save BIOS

In the very beginning, there is "Save Current BIOS" icon shown in dialog box. It means to save the current BIOS version.

IV. Check out supported motherboard and Flash ROM:

In the very beginning, there is "About this program" icon shown in dialog box. It can help you check out which kind of motherboard and which brand of Flash ROM are supported.

2. Note:

- I. In method I, if it shows two or more motherboard's model names to be selected, please make sure your motherboard's model name again. Selecting wrong model name will cause the system unbooted.
- II. In method II, be sure that motherboard's model name in BIOS unzip file are the same as your motherboard's. Otherwise, your system won't boot.
- III. In method I, if the BIOS file you need cannot be found in @BIOS™ server, please go onto Gigabyte's web site for downloading and updating it according to method II.
- IV. Please note that any interruption during updating will cause system unbooted.
- V. Do not use @BIOS and C.O.M. (Corporate Online Management) at the same time.

4-1-4 Configuring SATA Hard Drive(s)

To configure SATA hard drive(s), follow the steps below:

- (1) Install SATA hard drive(s) in your system.
- (2) Configure SATA controller mode and boot sequence in BIOS Setup.
- (3) Configure RAID set in RAID BIOS. ^(Note)
- (4) Make a floppy disk containing the SATA controller driver. ^(Note)
- (5) Install the SATA controller driver during OS installation. ^(Note)

Before you begin

Please prepare:

- (a) SATA hard drive(s). To ensure optimal performance, it is recommended that you use two hard drives with identical model and capacity for RAID array. If you do not want to create RAID, you may prepare only one hard drive.
- (b) An empty formatted floppy disk. ^(Note)
- (c) Windows XP/2000 setup disk.
- (d) Driver CD for your motherboard. ^(Note)

(1) Installing SATA hard drive(s) in your computer

Attach one end of the SATA signal cable to the rear of the SATA hard drive and the other end to available SATA port(s) on the motherboard. Then connect the power connector from your power supply to the hard drive.

(Note) Required for setting up RAID array.

(2) Configuring SATA controller mode and boot sequence in BIOS Setup

You have to make sure whether the SATA controller is configured correctly in system BIOS Setup and set BIOS boot sequence for the SATA hard drive(s)/RAID array.

Step 1:

Turn on your computer and press Del to enter BIOS Setup during POST (Power-On Self Test). In the example in Figure 1, make sure that **NV Serial-ATA 1** under the **Integrated Peripherals** menu is enabled. If you wish to create RAID array, press ENTER on the **Serial-ATA RAID Config** item to enter the submenu .

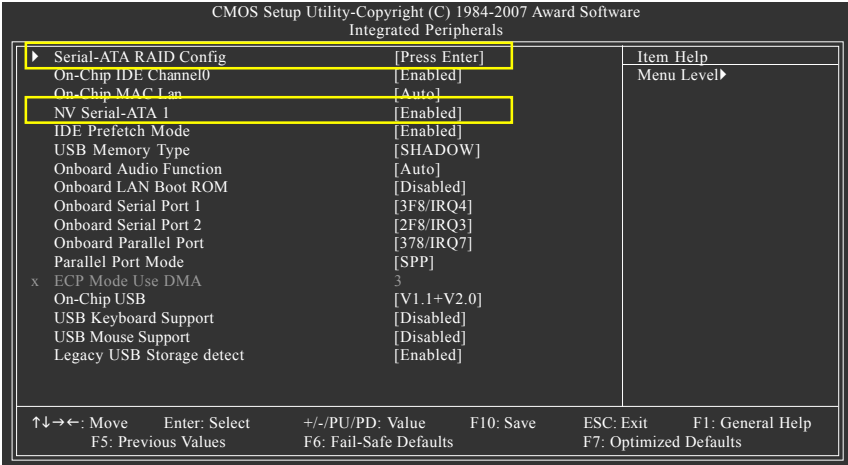

Figure 1

In the **Serial-ATA RAID Config** submenu, enable **NV SATA RAID function**. Then enable the SATA ports with hard disks that you want to use for RAID. In the example in Figure 2, enable **NV SATA 1 Primary/Secondary RAID**.

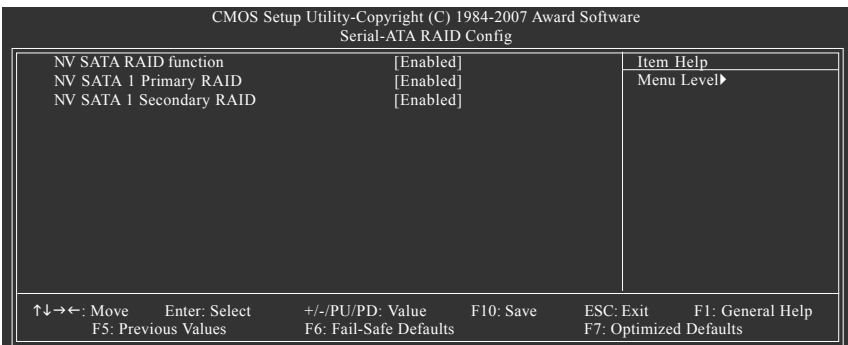

Figure 2



The BIOS Setup menus described in this section may not show the exact settings for your motherboard. The actual BIOS Setup menu options you will see shall depend on the motherboard you have and the BIOS version.

Step 2:

To boot from Windows installation CD-ROM disk, set **First Boot Device** under the **Advanced BIOS Features** menu to **CDROM** (Figure 3).

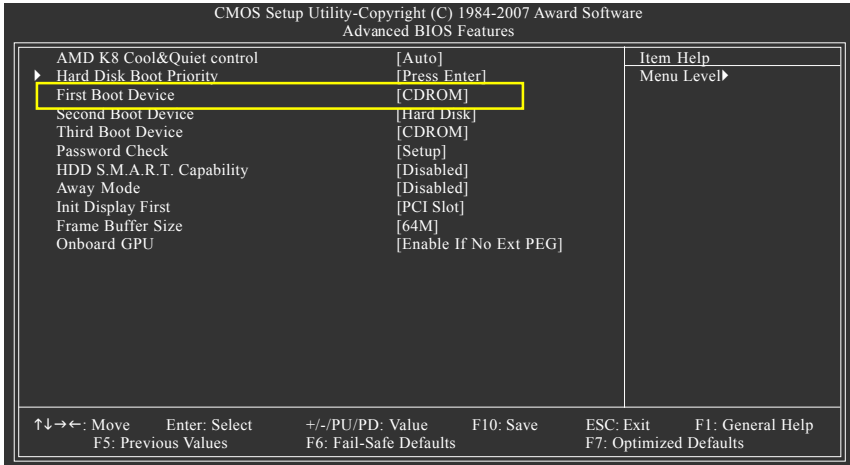

Figure 3

Step 3:

Save and exit BIOS Setup.

(3) Configuring RAID set in RAID BIOS

Enter the RAID BIOS setup utility to configure a RAID array. Skip this step if you do not want to create RAID.

Step 1:

After the POST memory test begins and before the operating system boot begins, look for a message which says "Press F10 to enter RAID setup utility" (Figure 4). Hit the **F10** key to enter the RAID BIOS setup utility.



Figure 4

Step 2:

The Define a New Array screen is the first option screen when you enter the NVIDIA RAID setup utility. (Figure 5). You can press the TAB key to highlight through options.

Step 3:

In the RAID Mode field, use the UP or DOWN ARROW key to select a RAID mode. The supported RAID modes include Mirroring (default), Striping. The following is an example of RAID 0 array creation.

Step 4:

If RAID 0 (Striping) is selected, you can manually set the striping block size. In the Striping Block field, use the UP or DOWN ARROW key to set the Striping Block size. The KB is the standard unit of Striping Block size. We recommend you leaving it to the default setting--Optimal (64 K). The size range is from 4 K to 128 K.

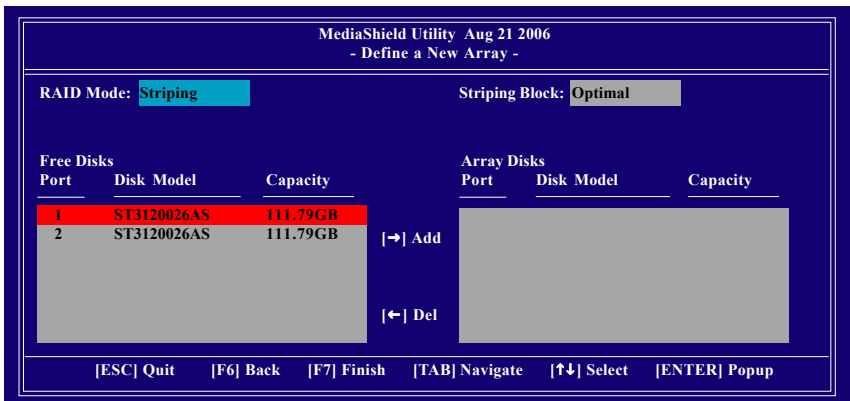

Figure 5

Step 5:

Next, select the hard drives which you wish to be included in the disk array. The Free Disks section displays the information about the currently installed SATA hard drives. Press the TAB key to move to the Free Disks section. Select the target hard drives using the UP or DOWN ARROW key and use the RIGHT ARROW key to add the hard drives to the Array Disks section (Figure 6).

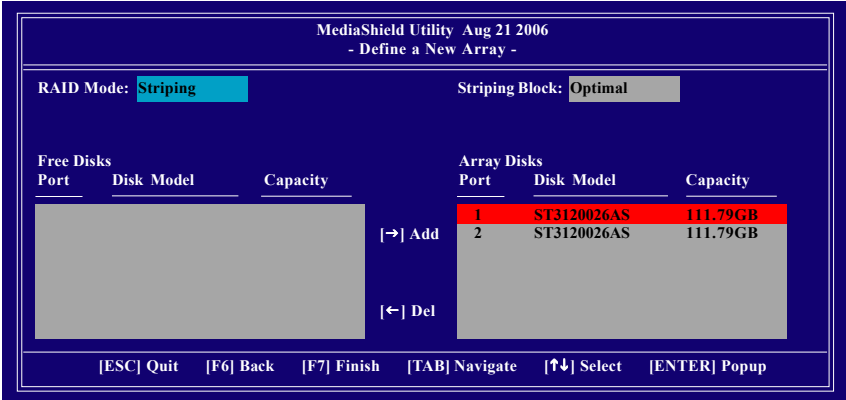

Figure 6

Step 6:

Press F7 after selecting the target hard disks. A message which says "Clear disk data?" will appear (Figure 7). If you are sure to clear the data in the selected hard drives, press Y. (If the hard drives contain previously created RAID array, you need to press Y to clear the data from the hard drives.)

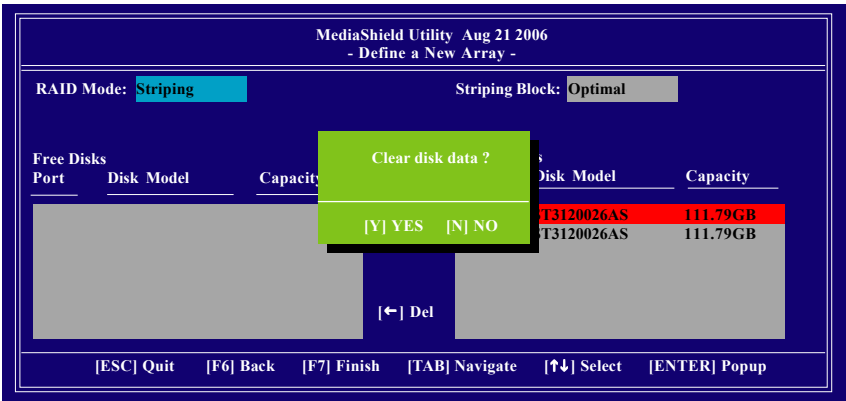

Figure 7

After that, the Array List screen displaying the RAID array you created will appear (Figure 8). (Note: **BBS** stands for BIOS Boot Specification. This indicates that the boot device is defined in the BIOS.)

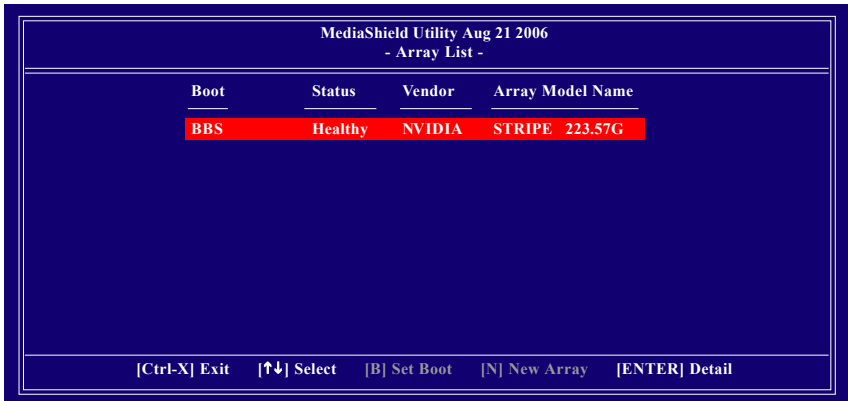

Figure 8

To read more information about the RAID array, press ENTER to enter the Array Detail screen (Figure 9), where you should see detailed information about RAID mode, disk block size, disk model name, and disk capacity, etc.

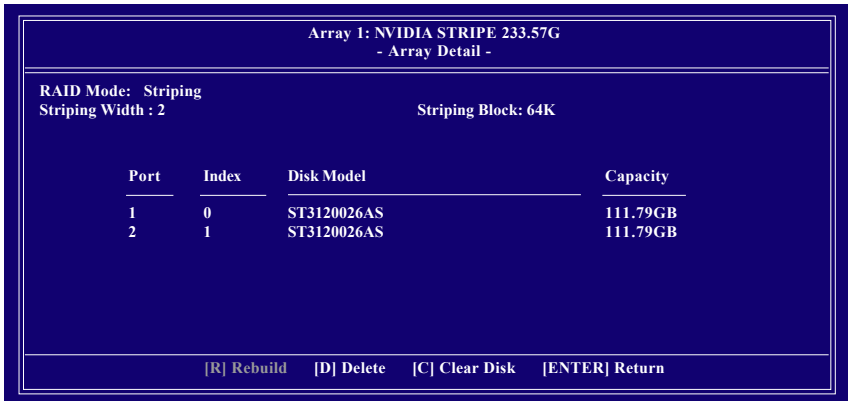

Figure 9

To delete the array, press D in the Array Detail screen. When the "Delete this array?" message appears, press Y to confirm or N to cancel. Press ENTER to return to the Array List screen.

To exit the Nvidia RAID utility, press ESC in the main menu or Ctrl+X in the Array List screen.

Now, you can proceed to install the SATA controller driver and operating system.

(4) Making a SATA Driver Disk

To install operating system onto RAID disks successfully, you need to install the SATA RAID driver during OS installation. Without the driver, the hard disk may not be recognized during the Windows setup process. Skip this step if you do not want to create RAID. First of all, copy the driver for the SATA controller from the motherboard driver CD-ROM to a floppy disk. See the instructions below about how to copy the driver in MS-DOS mode^(Note). Prepare a startup disk that has CD-ROM support and a blank formatted floppy disk.

Step 1: Insert the prepared startup disk and motherboard driver CD-ROM in your system. Boot from the startup disk. Once at the A:\> prompt, change to the CD-ROM drive (example: D:\>). At the D:\> prompt, type the following two commands. Press ENTER after each command (Figure 10):

```
cd bootdrv
menu
```

Step 2: When the controller menu (Figure 11) appears, remove the startup disk and insert the blank formatted disk. Select the controller driver by pressing the corresponding letter from the menu. For example, from the menu in Figure 11, press A to select (A) nVIDIA MCP61 Series Raid (XP) if you wish to install Windows XP (32-bit). Your system will then automatically zip and transfer this driver file to the floppy disk. Press 0 to exit when finished.

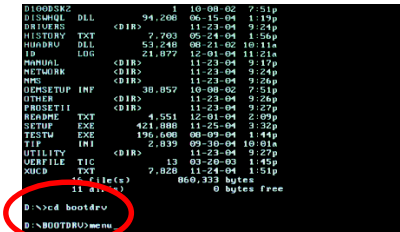

Figure 10

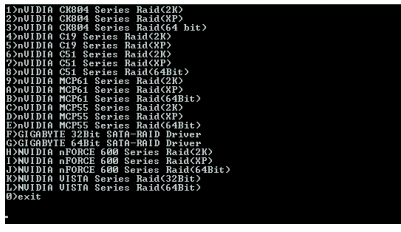

Figure 11

(Note) For users without a startup disk:

Use an alternative system and insert the GIGABYTE motherboard driver CD-ROM. From the CD-ROM drive folder, double click the MENU.exe file in the BootDrv folder (Figure 12). A command prompt window will open similar to that in Figure 11.

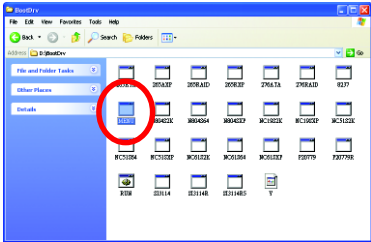

Figure 12

(5) Installing SATA controller driver during OS installation

Now that you have prepared the SATA driver disk and configured BIOS settings, you are ready to install Windows 2000/XP onto your SATA hard drive with the SATA driver. The following is an example of Windows XP installation.

Step 1: Restart your system to boot from the Windows 2000/XP Setup disk and press F6 as soon as you see the "Press F6 if you need to install a 3rd party SCSI or RAID driver" message (Figure 13). After pressing F6, there will be a few moments of some files being loaded before you see the next screen.

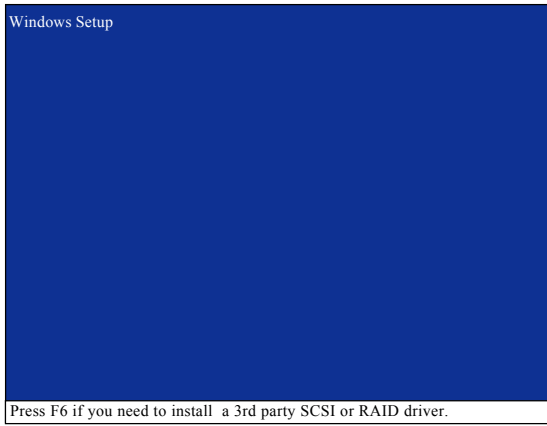

Figure 13

Step 2:

When a screen similar to that below appears, insert the floppy disk containing the SATA driver and press S (Figure 14).

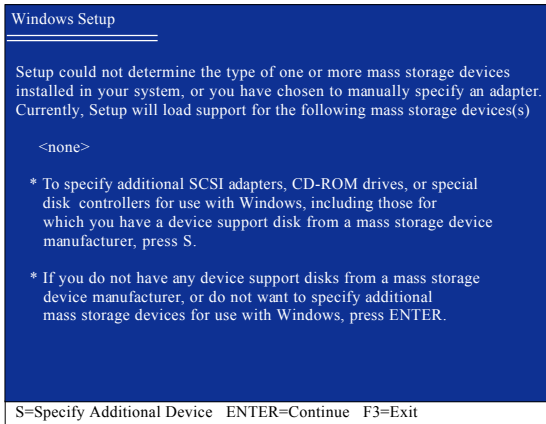

Figure 14

Step 3:

If Setup correctly recognizes the driver in the floppy disk, a controller menu similar to Figure 15 below will appear. Use the ARROW keys to select **NVIDIA RAID CLASS DRIVER** (Figure 15) and press ENTER. Later, when a screen similar to Figure 16 appears, you must press S to select additional driver. The screen will return to previous screen as shown in Figure 15. Select **NVIDIA nForce Storage Controller** and press ENTER.

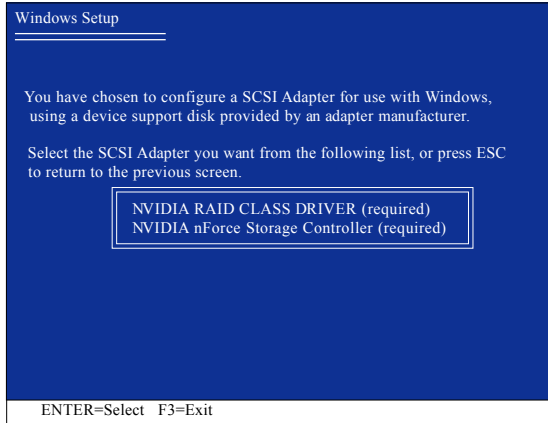

Figure 15

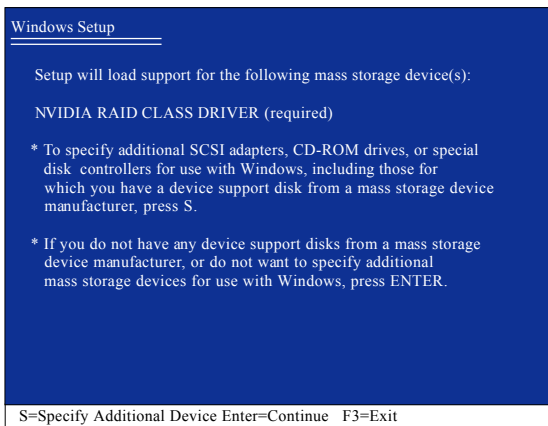

Figure 16



If a message appears saying one or some file(s) cannot be found, please check the floppy disk or copy the correct SATA driver again from the motherboard driver CD.

Step 4:

When the next screen (Figure 17) appears, press ENTER to continue the SATA driver installation from the floppy disk.

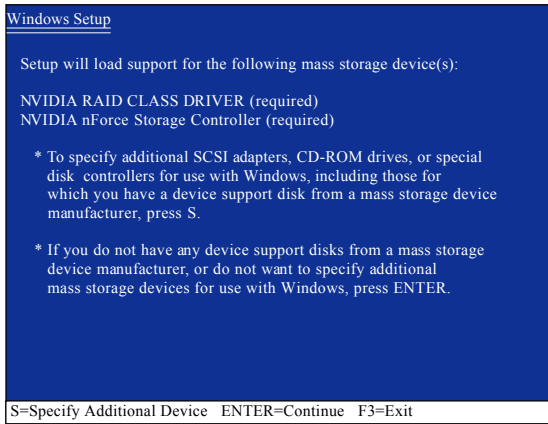

Figure 17

After the SATA controller driver installation is completed, you can proceed with the Windows 2000/XP installation.

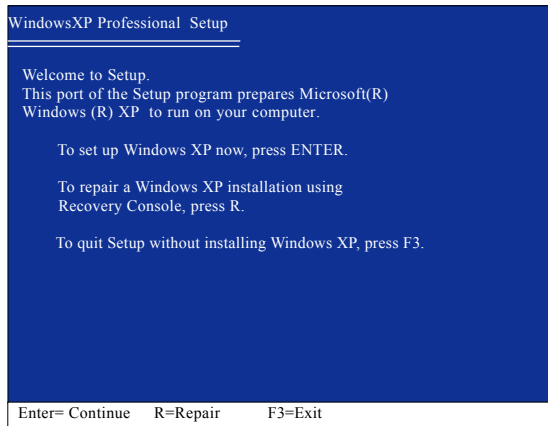

Figure 18

(Note: Each time you add a new hard drive to a RAID array, the RAID driver will have to be installed under Windows once for that hard drive. After that, the driver will not have to be installed.)



4-1-5 2- / 4- / 6- / 8- Channel Audio Introduction

This motherboard comes with three audio jacks. To set up multi-channel surround sound, install an additional 5.1/7.1 surround cable (optional) and enable the feature through the audio driver.

Installing the 5.1/7.1 Surround Cable (Optional)

The 5.1/7.1 Surround Cable provides center/subwoofer speaker out, rear speaker out, and side speaker out audio jacks. To set up multi-channel surround sound, this cable needs to be installed.



Step:

1. Connect the 5.1/7.1 surround cable connector to the HDA_SUR header on the motherboard.

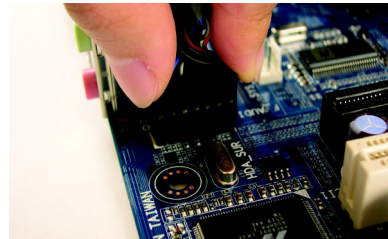

2. Secure the cable's metal bracket to the chassis back panel with a screw.

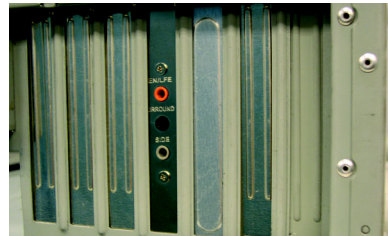

Audio Jacks Introduction

The optional 5.1/7.1 surround cable adds additional 3 audio jacks to the 3 onboard audio jacks. The picture to the right shows the default speaker settings for the 6 audio jacks. The jack retasking capability of HD Audio allows users to change the function for each jack through the audio driver.

For example, if a rear speaker is plugged into the center/subwoofer speaker out jack, you can reconfigure the center/subwoofer speaker out jack to function as a rear speaker out jack.

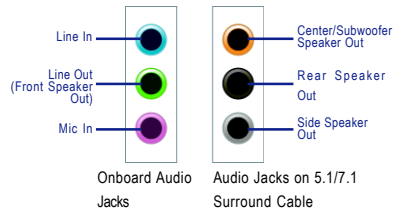

For the microphone to work correctly, you MUST connect it to either the default Mic In jack or the Line In jack and configure it in the audio driver.

HD Audio

With multiple built-in high quality digital-to-analog converters (DACs) that support audio output at up to 192 kHz/24-bit quality and multi-streaming applications, HD Audio is able to handle multiple audio streams (in and out) simultaneously. Multi-channel audio experiences have become a reality so you can, for instance, listen to MP3 music, have an Internet chat, make a telephone call over the Internet, and etc. all at the same time.

(The procedure below uses Windows XP as the example operating system.)

Setting Up Stereo Speakers

We recommend that you use the speaker with amplifier to acquire the best sound effect if the stereo output is applied.

STEP 1 :

After installation of the audio driver, you should find an Audio Manager  icon in your system tray (you can also find the icon in Control Panel). Double-click the icon to open the Audio Control Panel.

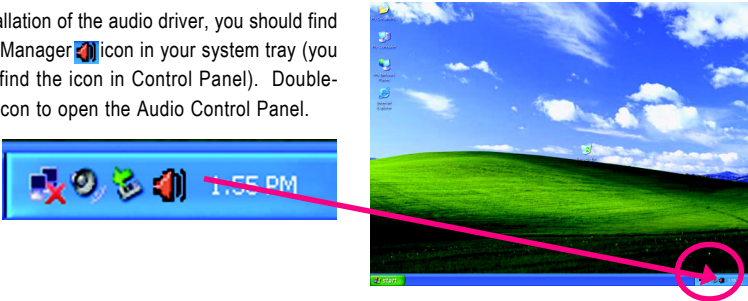

STEP 2:

In the Audio Control Panel, click the **Audio I/O** tab. In the upper left list, click **2CH Speaker**.



STEP 3:

Connect a speaker or headphone to the rear Line Out jack, a small window will pop up and ask you what type of equipment is connected. Choose **Headphone** or **Line Out** depending on the device connected and click **OK**. The 2-channel audio setup is completed.

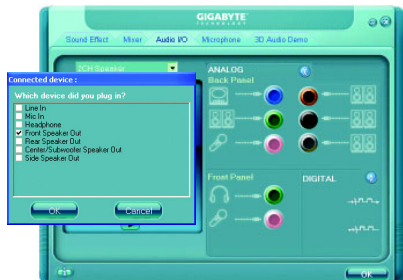

Setting Up 4-Channel Audio

STEP 1 :

After installation of the audio driver, you should find an Audio Manager  icon in your system tray (you can also find the icon in Control Panel). Double-click the icon to open the Audio Control Panel.

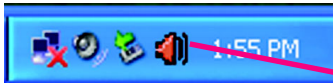

STEP 2:

In the Audio Control Panel, click the **Audio I/O** tab. In the upper left list, click **4CH Speaker**.



STEP 3:

Connect the 4-channel speakers to the audio jacks on the motherboard and the surround cable, a small window will pop up and ask you what type of equipment is connected. Choose a device depending on the type of speaker connected (4-channel audio consists of Front Speaker Out (Line Out) and Rear Speaker Out) and then click **OK**. The 4-channel audio setup is completed.

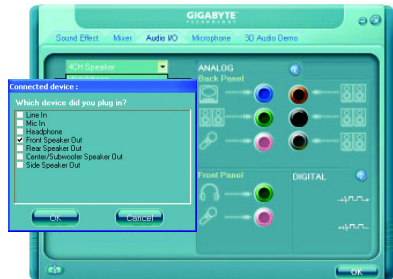

Setting Up 6-Channel Audio

STEP 1 :

After installation of the audio driver, you should find an Audio Manager  icon in your system tray (you can also find the icon in Control Panel). Double-click the icon to open the Audio Control Panel.

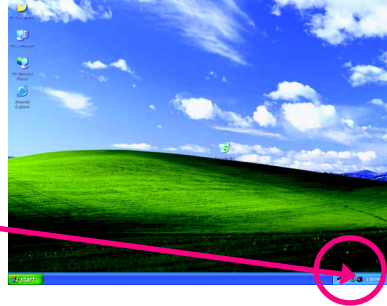

STEP 2:

In the Audio Control Panel, click the **Audio I/O** tab.
In the upper left list, click **6CH Speaker**.



STEP 3:

Connect the 6-channel speakers to the audio jacks on the motherboard and the surround cable, a small window will pop up and ask you what type of equipment is connected. Choose a device depending on the type of speaker connected (6-channel audio consists of Front Speaker Out (Line Out), Rear Speaker Out, and Center/Subwoofer Speaker Out) then click **OK**. The 6-channel audio setup is completed.

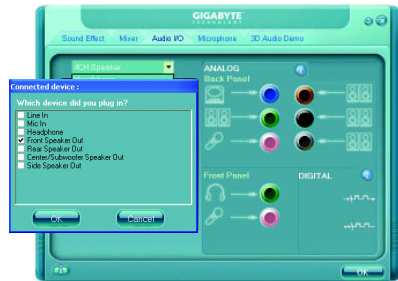

Setting Up 8-Channel Audio

STEP 1 :

After installation of the audio driver, you should find an Audio Manager  icon in your system tray (you can also find the icon in Control Panel). Double-click the icon to open the Audio Control Panel.

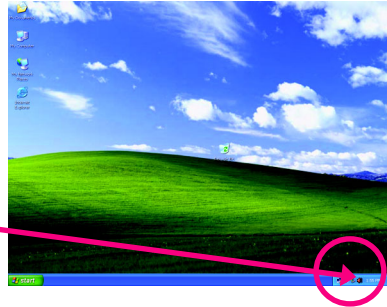

STEP 2:

In the Audio Control Panel, click the **Audio I/O** tab. In the upper left list, click **8CH Speaker**.

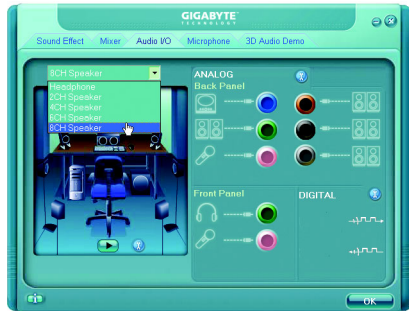

STEP 3:

Connect the 8-channel speakers to the audio jacks on the motherboard and the surround cable, a small window will pop up and ask you what type of equipment is connected. Choose a device depending on the type of speaker connected (8-channel audio consists of Front Speaker Out (Line Out), Rear Speaker Out, Center/Subwoofer Speaker Out, and Side Speaker Out) then click **OK**. The 8-channel audio setup is completed.

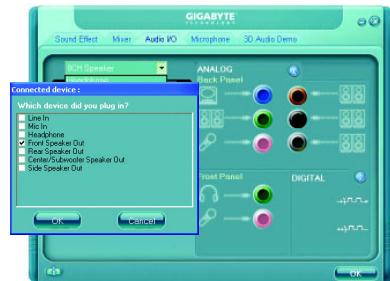

Sound Effect Configuration:

At the **Sound Effect** menu, users can adjust sound option settings as desired.



AC'97 Audio Configuration:

To enable the front panel audio connector to support AC97 Audio mode, go to the Audio Control Panel and click the **Audio I/O** tab. In the **ANALOG** area, click the **Tool** icon and then select the **Disable front panel jack detection** check box. This action completes the AC'97 Audio configuration.

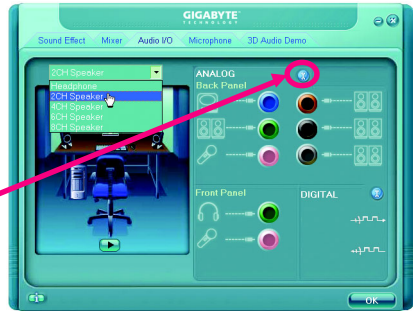

4-2 Troubleshooting

4-2-1 Frequently Asked Questions

To read more FAQs for your motherboard, please go to the Support\Motherboard\FAQ page on GIGABYTE's website.

Q: In the BIOS Setup program, why are some BIOS options missing?

A: Some advanced options are hidden in the BIOS Setup program. Press <Delete> to enter BIOS Setup during the POST. In the Main Menu, press <Ctrl>+<F1> to show the advanced options.

Q: Why is the light of my keyboard/optical mouse still on after the computer shuts down?

A: Some motherboard provides a small amount of standby power after the computer shuts down and that's why the light is still on.

Q: How do I clear the CMOS values?

A: If your motherboard has a clearing CMOS jumper, refer to the instructions on the CLR_CMOS jumper in Chapter 1 to short the jumper to clear the CMOS values. If your board doesn't have this jumper, refer to the instructions on the motherboard battery in Chapter 1. You can temporarily remove the battery from the battery holder to stop supplying power to the CMOS, which will clear the CMOS values after about one minute. Refer to the steps below:

Steps:

1. Turn off your computer and unplug the power cord.
2. Gently remove the battery from the battery holder and wait for one minute.
(Or use a metal object like a screwdriver to touch the positive and negative terminals of the battery holder, making them short for 5 seconds.)
3. Replace the battery.
4. Plug in the power cord and restart your computer.
5. Press <Delete> to enter BIOS Setup. Select "Load Fail-Safe Defaults" (or "Load Optimized Defaults") to load BIOS default settings.
6. Saves changes and exit BIOS Setup (select "Save & Exit Setup") to restart your computer.

Q: Why do I still get a weak sound even though I have turned my speaker to the maximum volume?

A: Make sure your speaker is equipped with an internal amplifier. If not, try a speaker with power/amplifier.

Q: What do the beeps emitted during the POST mean?

A: The following Award BIOS beep code descriptions may help you identify possible computer problems. (For reference only.)

1 short: System boots successfully

2 short: CMOS setting error

1 long, 1 short: Memory or motherboard error

1 long, 2 short: Monitor or graphics card error

1 long, 3 short: Keyboard error

1 long, 9 short: BIOS ROM error

Continuous long beeps: Graphics card not inserted properly

Continuous short beeps: Power error

4-2-2 Troubleshooting Procedure

If you encounter any troubles during system startup, follow the troubleshooting procedure below to solve the problem.

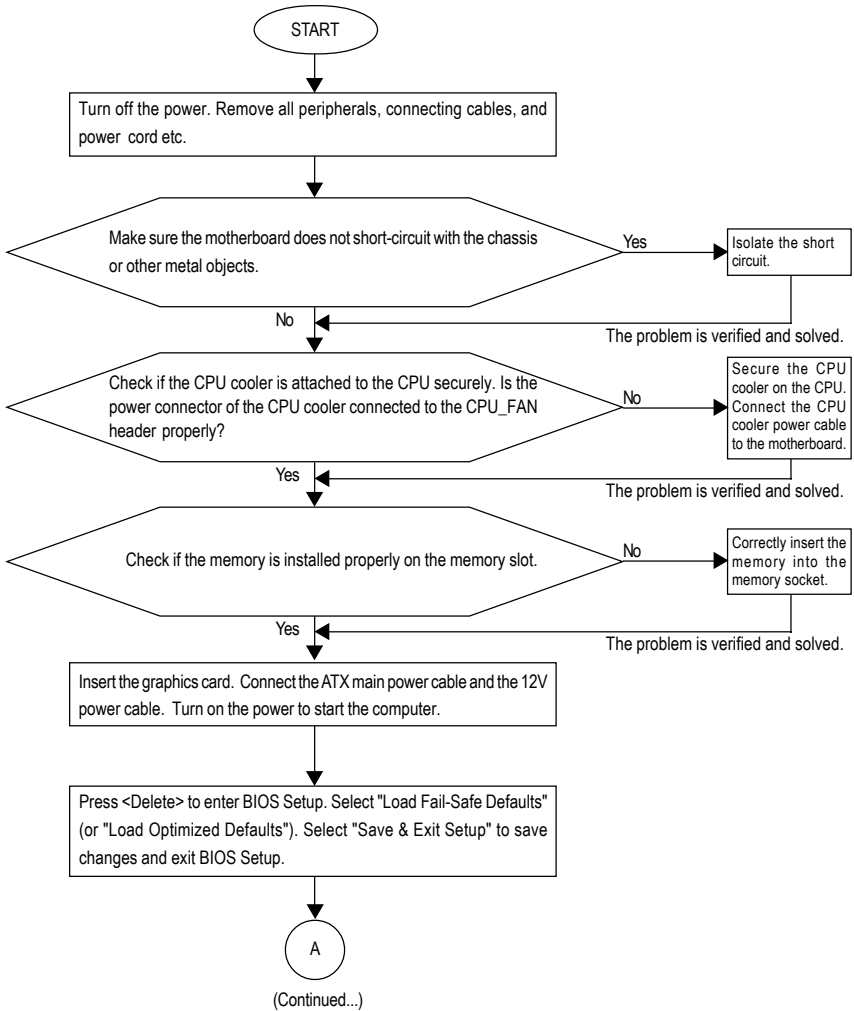

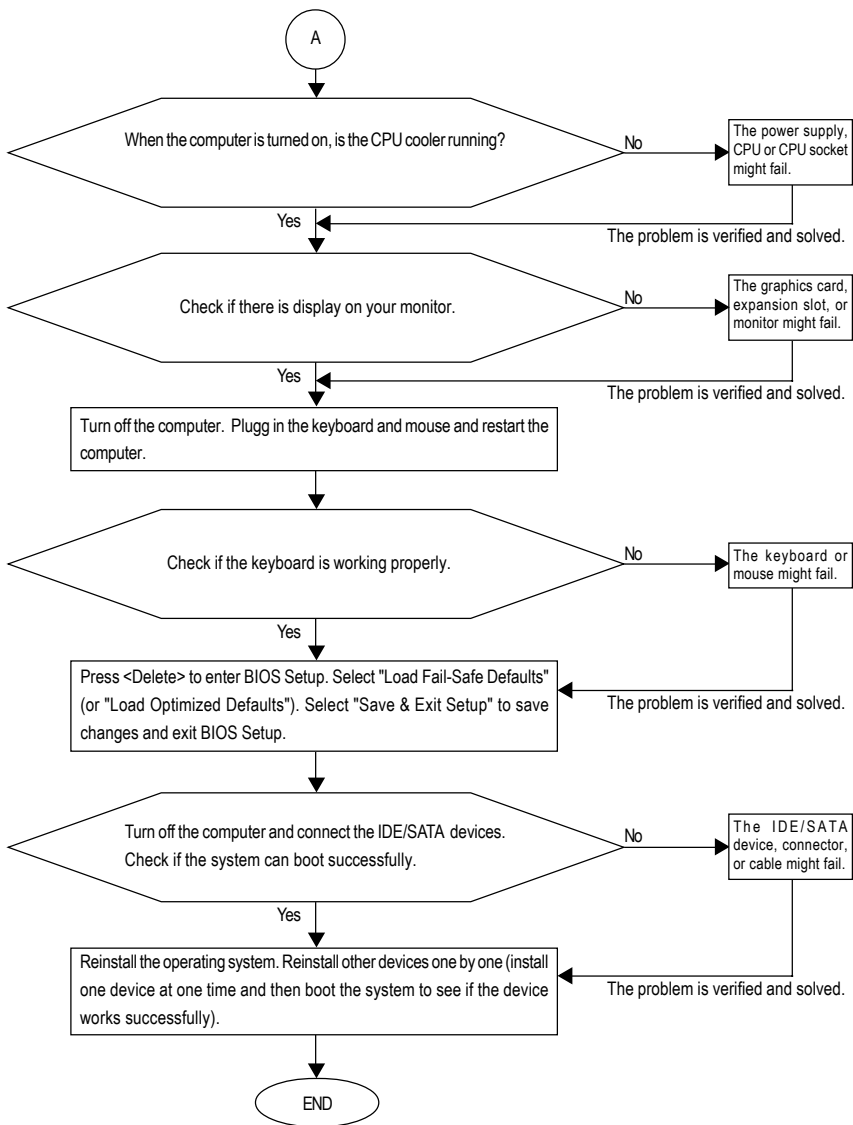

If the procedure above is unable to solve your problem, contact the place of purchase or local dealer for help. Or go to the Support/Technical Service Zone page to submit your question. Our customer service staff will reply you as soon as possible.

Regulatory Statements

Regulatory Notices

This document must not be copied without our written permission, and the contents there of must not be imparted to a third party nor be used for any unauthorized purpose. Contravention will be prosecuted. We believe that the information contained herein was accurate in all respects at the time of printing. GIGABYTE cannot, however, assume any responsibility for errors or omissions in this text. Also note that the information in this document is subject to change without notice and should not be construed as a commitment by GIGABYTE.

Our Commitment to Preserving the Environment

In addition to high-efficiency performance, all GIGABYTE motherboards fulfill European Union regulations for RoHS (Restriction of Certain Hazardous Substances in Electrical and Electronic Equipment) and WEEE (Waste Electrical and Electronic Equipment) environmental directives, as well as most major worldwide safety requirements. To prevent releases of harmful substances into the environment and to maximize the use of our natural resources, GIGABYTE provides the following information on how you can responsibly recycle or reuse most of the materials in your "end of life" product.

Restriction of Hazardous Substances (RoHS) Directive Statement

GIGABYTE products have not intended to add and safe from hazardous substances (Cd, Pb, Hg, Cr+6, PBDE and PBB). The parts and components have been carefully selected to meet RoHS requirement. Moreover, we at GIGABYTE are continuing our efforts to develop products that do not use internationally banned toxic chemicals.

Waste Electrical & Electronic Equipment (WEEE) Directive Statement

GIGABYTE will fulfill the national laws as interpreted from the 2002/96/EC WEEE (Waste Electrical and Electronic Equipment) directive. The WEEE Directive specifies the treatment, collection, recycling and disposal of electric and electronic devices and their components. Under the Directive, used equipment must be marked, collected separately, and disposed of properly.

WEEE Symbol Statement



The symbol shown below is on the product or on its packaging, which indicates that this product must not be disposed of with other waste. Instead, the device should be taken to the waste collection centers for activation of the treatment, collection, recycling and disposal procedure. The separate collection and recycling of your waste equipment at the time of disposal will help to conserve natural resources and ensure that it is recycled in a manner that protects human health and the environment. For more information about where you can drop off your waste equipment for recycling, please contact your local government office, your household waste disposal service or where you purchased the product for details of environmentally safe recycling.

- ♦ When your electrical or electronic equipment is no longer useful to you, "take it back" to your local or regional waste collection administration for recycling.
- ♦ If you need further assistance in recycling, reusing in your "end of life" product, you may contact us at the Customer Care number listed in your product's user's manual and we will be glad to help you with your effort.

Finally, we suggest that you practice other environmentally friendly actions by understanding and using the energy-saving features of this product (where applicable), recycling the inner and outer packaging (including shipping containers) this product was delivered in, and by disposing of or recycling used batteries properly. With your help, we can reduce the amount of natural resources needed to produce electrical and electronic equipment, minimize the use of landfills for the disposal of "end of life" products, and generally improve our quality of life by ensuring that potentially hazardous substances are not released into the environment and are disposed of properly.

China Restriction of Hazardous Substances Table

The following table is supplied in compliance with China's Restriction of Hazardous Substances (China RoHS) requirements:



关于符合中国《电子信息产品污染控制管理办法》的声明
Management Methods on Control of Pollution from Electronic Information Products
(China RoHS Declaration)

产品中有毒有害物质或元素的名称及含量

Hazardous Substances Table

部件名称 (Parts)	有毒有害物质或元素 (Hazardous Substances)					
	铅 (Pb)	汞 (Hg)	镉 (Cd)	六价铬 (Cr (VI))	多溴联苯 (PBB)	多溴二苯醚 (PBDE)
PCB板 PCB	○	○	○	○	○	○
结构件及风扇 Mechanical parts and Fan	×	○	○	○	○	○
芯片及其他主动零件 Chip and other Active components	×	○	○	○	○	○
连接器 Connectors	×	○	○	○	○	○
被动电子元件 Passive Components	×	○	○	○	○	○
线材 Cables	○	○	○	○	○	○
焊接金属 Soldering metal	○	○	○	○	○	○
助焊剂, 散热膏, 标签及其他耗材 Flux, Solder Paste, Label and other Consumable Materials	○	○	○	○	○	○
○: 表示该有毒有害物质在该部件所有均质材料中的含量均在SJ/T11363-2006标准规定的限量要求以下。 Indicates that this hazardous substance contained in all homogenous materials of this part is below the limit requirement SJ/T 11363-2006						
×: 表示该有毒有害物质至少在该部件的某一均质材料中的含量超出SJ/T11363-2006标准规定的限量要求。 Indicates that this hazardous substance contained in at least one of the homogenous materials of this part is above the limit requirement in SJ/T 11363-2006						
对销售之日的所售产品, 本表显示我公司供应链的电子信息产品可能包含这些物质。注意: 在所售产品中可能会也可能不会含有所有列出的部件。 This table shows where these substances may be found in the supply chain of our electronic information products, as of the date of the sale of the enclosed products. Note that some of the component types listed above may or may not be a part of the enclosed product.						



Contact Us

- **Taiwan (Headquarters)**

GIGA-BYTE TECHNOLOGY CO., LTD.

Address: No.6, Bau Chiang Road, Hsin-Tien,

Taipei 231, Taiwan

TEL: +886-2-8912-4888

FAX: +886-2-8912-4003

Tech. and Non-Tech. Support (Sales/Marketing) :

<http://ggts.gigabyte.com.tw>

WEB address (English): <http://www.gigabyte.com.tw>

WEB address (Chinese): <http://www.gigabyte.tw>

- **U.S.A.**

G.B.T. INC.

TEL: +1-626-854-9338

FAX: +1-626-854-9339

Tech. Support:

<http://rma.gigabyte-usa.com>

Web address: <http://www.gigabyte.us>

- **Mexico**

G.B.T Inc (USA)

Tel: +1-626-854-9338 x 215 (Soporte de habla hispano)

FAX: +1-626-854-9339

Correo: soporte@gigabyte-usa.com

Tech. Support:

<http://rma.gigabyte-usa.com>

Web address: <http://www.gigabyte.com.mx>

- **Singapore**

GIGA-BYTE SINGAPORE PTE. LTD.

WEB address : <http://www.gigabyte.sg>

- **Thailand**

WEB address : <http://th.giga-byte.com>

- **Vietnam**

WEB address : <http://www.gigabyte.vn>

- **China**

NINGBO G.B.T. TECH. TRADING CO., LTD.

WEB address : <http://www.gigabyte.cn>

- **Shanghai**

TEL: +86-21-63410999

FAX: +86-21-63410100

- **Beijing**

TEL: +86-10-62102838

FAX: +86-10-62102848

- **Wuhan**

TEL: +86-27-87851061

FAX: +86-27-87851330

- **GuangZhou**

TEL: +86-20-87540700

FAX: +86-20-87544306 ext. 333

- **Chengdu**

TEL: +86-28-85236930

FAX: +86-28-85256822 ext. 814

- **Xian**

TEL: +86-29-85531943

FAX: +86-29-85539821

- **Shenyang**

TEL: +86-24-83992901

FAX: +86-24-83992909

- **India**

GIGABYTE TECHNOLOGY (INDIA) LIMITED

WEB address : <http://www.gigabyte.in>

- **Saudi Arabia**

WEB address : <http://www.gigabyte.com.sa>

- **Australia**

GIGABYTE TECHNOLOGY PTY. LTD.

WEB address : <http://www.gigabyte.com.au>

- **Germany**

G.B.T. TECHNOLOGY TRADING GMBH

WEB address : <http://www.gigabyte.de>

- **U.K.**

G.B.T. TECH. CO., LTD.

WEB address : <http://www.giga-byte.co.uk>

- **The Netherlands**

GIGA-BYTE TECHNOLOGY B.V.

WEB address : <http://www.giga-byte.nl>

- **Sweden**

WEB address : <http://www.gigabyte.se>

- **France**

GIGABYTE TECHNOLOGY FRANCE

WEB address : <http://www.gigabyte.fr>

- **Italy**

WEB address : <http://www.giga-byte.it>

- **Spain**

GIGA-BYTE SPAIN

WEB address : <http://www.giga-byte.es>

- **Czech Republic**

Representative Office Of GIGA-BYTE Technology Co., Ltd.
in CZECH REPUBLIC

WEB address : <http://www.gigabyte.cz>

- **Turkey**

Representative Office Of GIGA-BYTE Technology Co., Ltd.
in TURKEY

WEB address : <http://www.gigabyte.com.tr>

- **Russia**

Moscow Representative Office Of GIGA-BYTE Technology Co., Ltd.

WEB address : <http://www.gigabyte.ru>

- **Latvia**

GIGA-BYTE Latvia

WEB address : <http://www.gigabyte.lv>

- **Poland**

Office of GIGA-BYTE TECHNOLOGY Co., Ltd. in POLAND

WEB address : <http://www.gigabyte.pl>

- **Ukraine**

WEB address : <http://www.giga-byte.com.ua>

- **Romania**

Representative Office Of GIGA-BYTE Technology Co., Ltd.
in Romania

WEB address : <http://www.gigabyte.com.ro>

- **Serbia & Montenegro**

Representative Office Of GIGA-BYTE Technology Co., Ltd.
in SERBIA & MONTENEGRO

WEB address : <http://www.gigabyte.co.yu>

You may go to the GIGABYTE website, select your language
in the language list on the top right corner of the website.

- **GIGABYTE Global Service System**



To submit a technical or non-technical (Sales/Marketing) question, please link to :

<http://ggts.gigabyte.com.tw>

Then select your language to enter the system.