



Dual N-Channel Enhancement Mode Field Effect Transistor

PRODUCT SUMMARY		
V _{DSS}	I _D	R _{DS(ON)} (mΩ) Max
20V	8A	13.5 @ V _{GS} =4.0V
		20.0 @ V _{GS} =2.5V

FEATURES

- Super high dense cell design for low R_{DS(ON)}.
- Rugged and reliable.
- Surface Mount Package.
- ESD Protected.

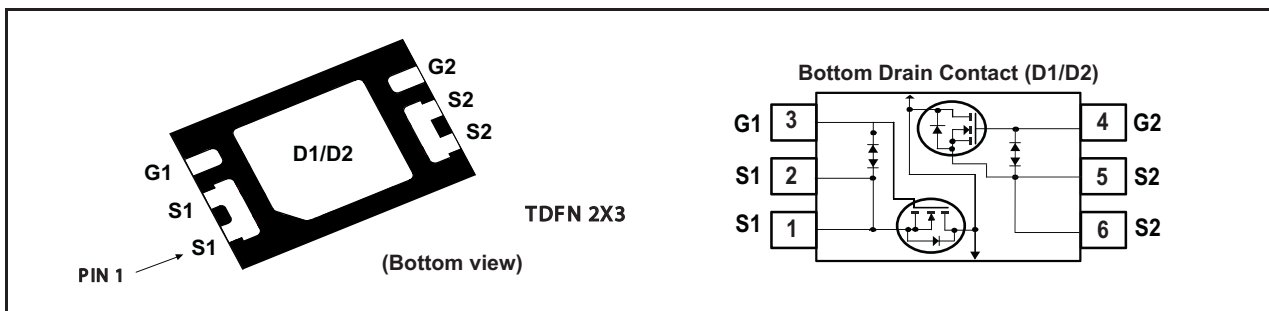

ABSOLUTE MAXIMUM RATINGS (T_A=25°C unless otherwise noted)

Symbol	Parameter	Limit	Units
V _{DS}	Drain-Source Voltage	20	V
V _{GS}	Gate-Source Voltage	±12	V
I _D	Drain Current-Continuous ^c	T _A =25°C	8
		T _A =70°C	6.4
I _{DM}	-Pulsed ^{a c}	48	A
P _D	Maximum Power Dissipation	T _A =25°C	1.56
		T _A =70°C	1.00
T _J , T _{STG}	Operating Junction and Storage Temperature Range	-55 to 150	°C

THERMAL CHARACTERISTICS

R _{θJA}	Thermal Resistance, Junction-to-Ambient	80	°C/W
------------------	---	----	------

STF8211

Ver 1.5

ELECTRICAL CHARACTERISTICS (TA=25°C unless otherwise noted)

Symbol	Parameter	Conditions	Min	Typ	Max	Units
OFF CHARACTERISTICS						
BV _{DSS}	Drain-Source Breakdown Voltage	V _{GS} =0V , I _D =250uA	20			V
I _{DSS}	Zero Gate Voltage Drain Current	V _{DS} =16V , V _{GS} =0V			1	uA
I _{GSS}	Gate-Body Leakage Current	V _{GS} = ±8V , V _{DS} =0V			±1	uA
ON CHARACTERISTICS						
V _{GS(th)}	Gate Threshold Voltage	V _{DS} =V _{GS} , I _D =250uA	0.5	0.7	1.5	V
R _{DS(ON)}	Drain-Source On-State Resistance	V _{GS} =4.0V , I _D =2.0A	8.0	10.5	13.5	m ohm
		V _{GS} =3.7V , I _D =2.0A	8.5	11.0	14.5	m ohm
		V _{GS} =3.1V , I _D =2.0A	9.5	12.5	16.5	m ohm
		V _{GS} =2.5V , I _D =2.0A	10.5	15.0	20.0	m ohm
g _{FS}	Forward Transconductance	V _{DS} =5V , I _D =4A		35		S
DYNAMIC CHARACTERISTICS ^b						
C _{ISS}	Input Capacitance	V _{DS} =10V, V _{GS} =0V f=1.0MHz		705		pF
C _{OSS}	Output Capacitance			235		pF
C _{RSS}	Reverse Transfer Capacitance			218		pF
SWITCHING CHARACTERISTICS ^b						
t _{D(ON)}	Turn-On Delay Time	V _{DD} =10V I _D =1A V _{GS} =4.0V R _{GEN} =6 ohm		25		ns
t _r	Rise Time			89		ns
t _{D(OFF)}	Turn-Off Delay Time			110		ns
t _f	Fall Time			102		ns
Q _g	Total Gate Charge	V _{DS} =10V, I _D =4A, V _{GS} =4.0V		13.4		nC
		V _{DS} =10V, I _D =4A, V _{GS} =2.5V		10.2		nC
Q _{gs}	Gate-Source Charge	V _{DS} =10V, I _D =4A,		2		nC
Q _{gd}	Gate-Drain Charge	V _{GS} =4V		6		nC
DRAIN-SOURCE DIODE CHARACTERISTICS AND MAXIMUM RATINGS						
V _{SD}	Diode Forward Voltage	V _{GS} =0V, I _S =1A		0.76	1.2	V

Notes

- a. Pulse Test: Pulse Width ≤ 10us, Duty Cycle ≤ 1%.
- b. Guaranteed by design, not subject to production testing.
- c. Drain current limited by maximum junction temperature.
- d. Mounted on FR4 Board of 1 inch² , 2oz.

Jul, 18, 2014

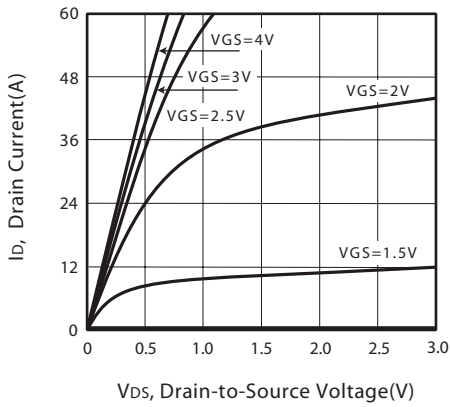

Figure 1. Output Characteristics

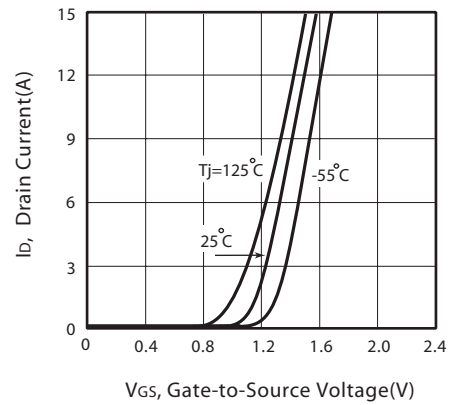

Figure 2. Transfer Characteristics

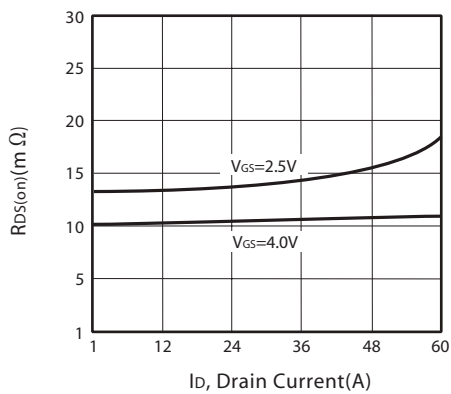

Figure 3. On-Resistance vs. Drain Current and Gate Voltage

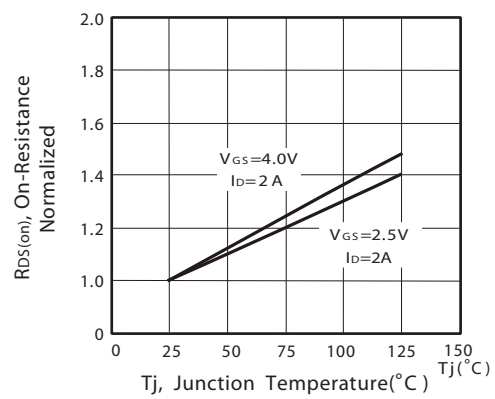

Figure 4. On-Resistance Variation with Drain Current and Temperature

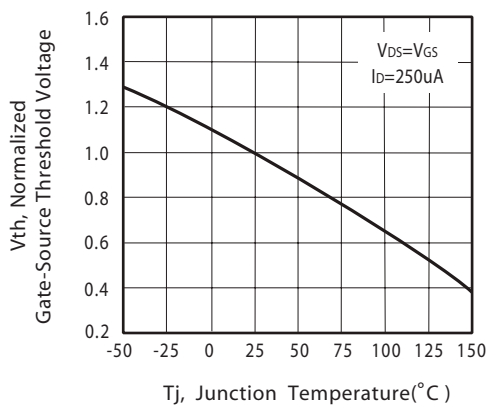

Figure 5. Gate Threshold Variation with Temperature

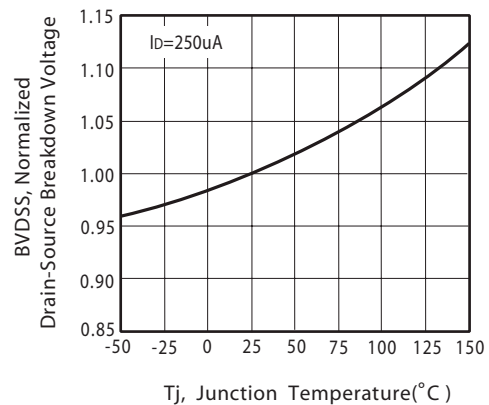

Figure 6. Breakdown Voltage Variation with Temperature

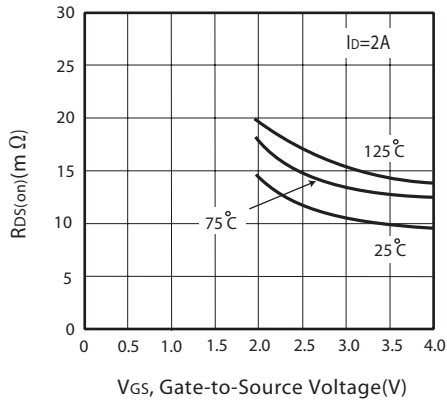

Figure 7. On-Resistance vs. Gate-Source Voltage

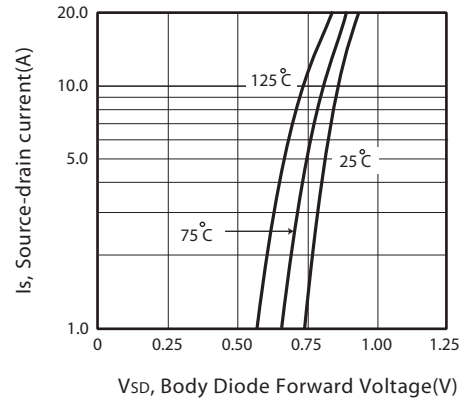

Figure 8. Body Diode Forward Voltage Variation with Source Current

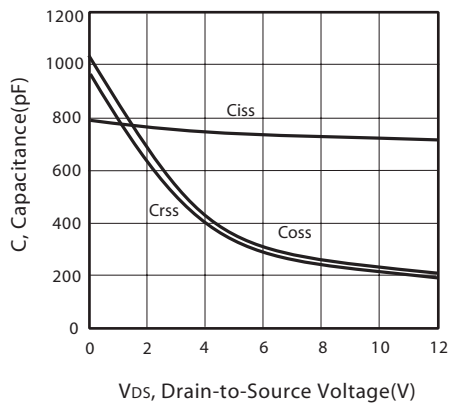

Figure 9. Capacitance

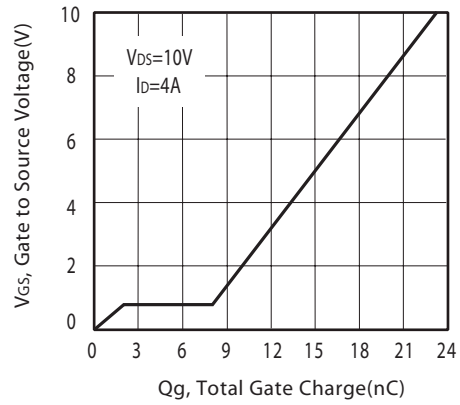

Figure 10. Gate Charge

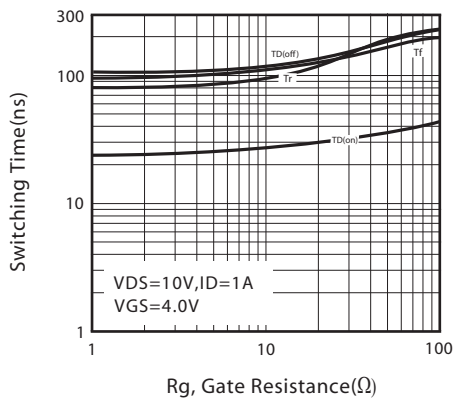

Figure 11. switching characteristics

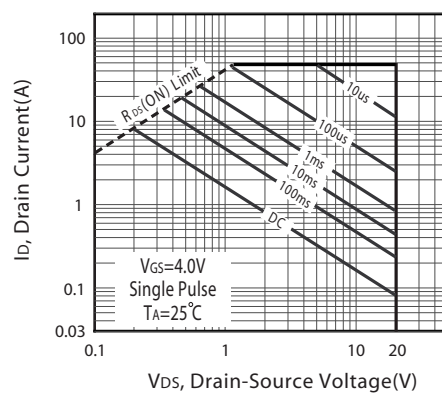
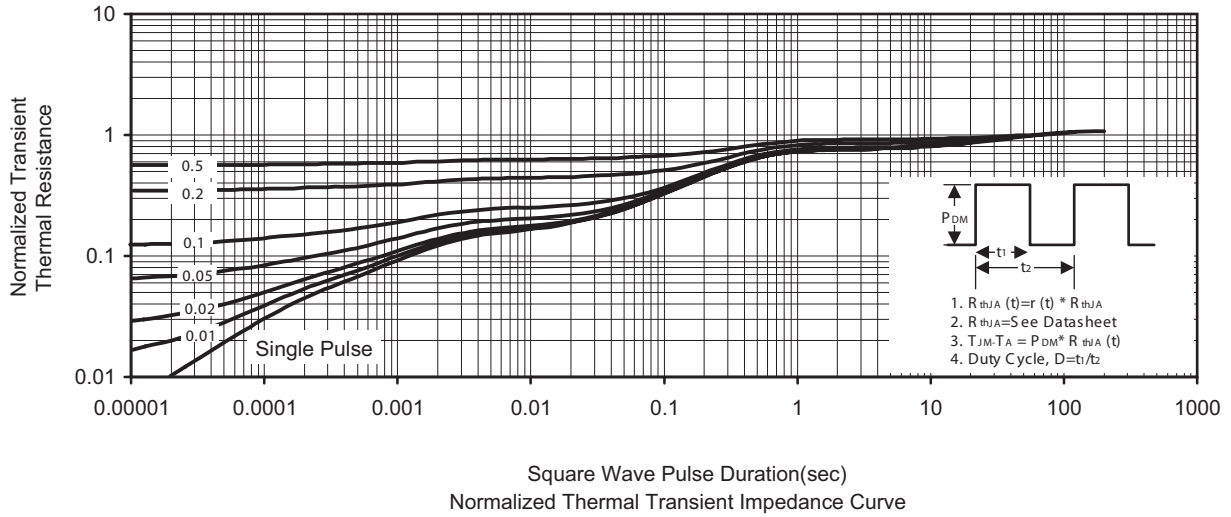
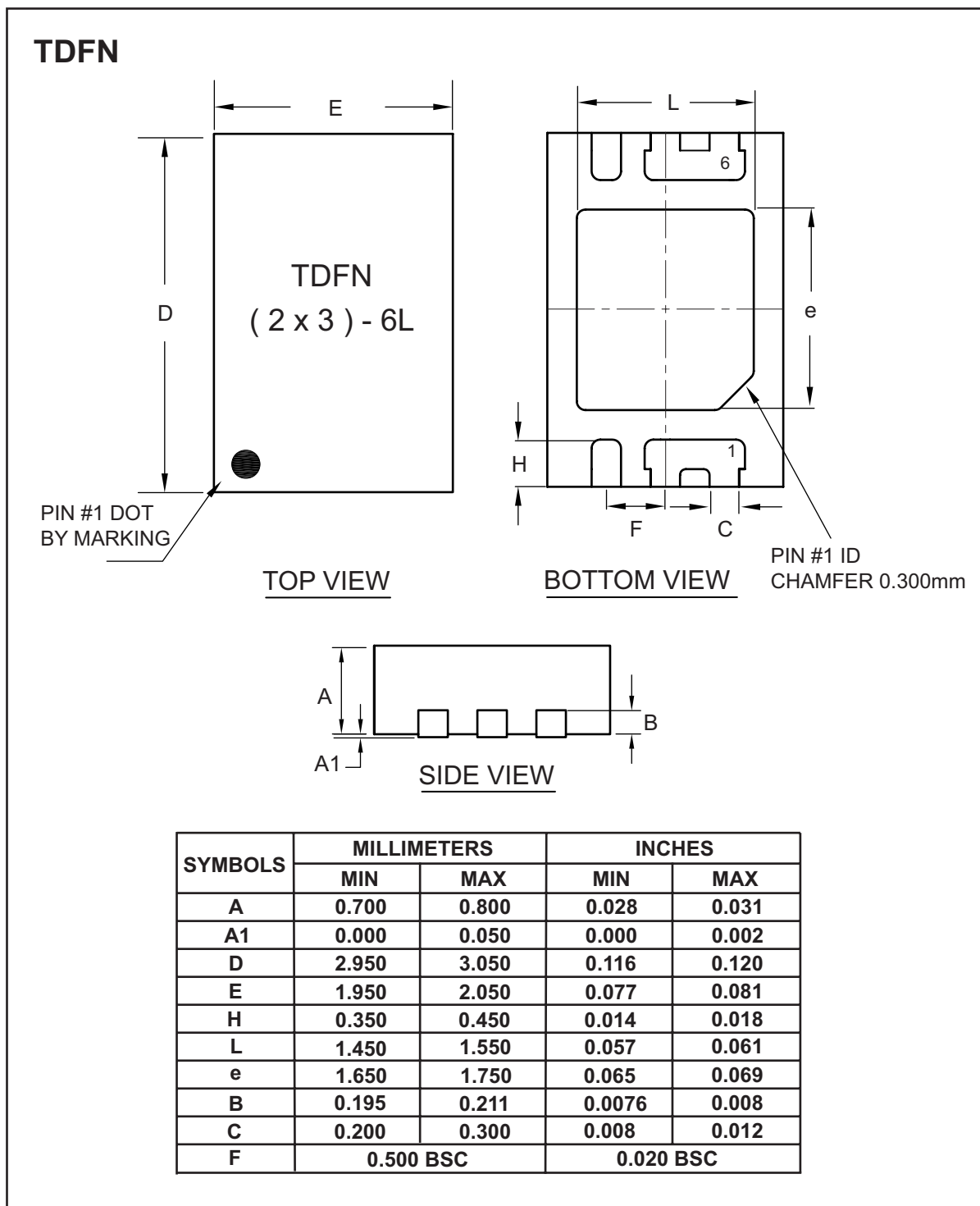

Figure 12. Maximum Safe Operating Area



PACKAGE OUTLINE DIMENSIONS



TOP MARKING DEFINITION

