

**NEC** NEC LCD Technologies, Ltd.

# **TFT MONOCHROME LCD MODULE**

**NL204153BM21-01**  
**NL204153BM21-01A**

**54cm (21.3 Type)**  
**QXGA**  
**LVDS Interface (4 ports)**

**DATA SHEET**  
**DOD-PD-1318 (4th edition)**

**This DATA SHEET is updated document from  
DOD-PD-0884(3).**

**All information is subject to change without notice.  
Please confirm the sales representative before  
starting to design your system.**

## INTRODUCTION

The Copyright to this document belongs to NEC LCD Technologies, Ltd. (hereinafter called "NEC"). No part of this document will be used, reproduced or copied without prior written consent of NEC.

NEC does and will not assume any liability for infringement of patents, copyrights or other intellectual property rights of any third party arising out of or in connection with application of the products described herein except for that directly attributable to mechanisms and workmanship thereof. No license, express or implied, is granted under any patent, copyright or other intellectual property right of NEC.

Some electronic parts/components would fail or malfunction at a certain rate. In spite of every effort to enhance reliability of products by NEC, the possibility of failures and malfunction might not be avoided entirely. To prevent the risks of damage to death, human bodily injury or other property arising out thereof or in connection therewith, each customer is required to take sufficient measures in its safety designs and plans including, but not limited to, redundant system, fire-containment and anti-failure.

The products are classified into three quality grades: "**Standard**", "**Special**", and "**Specific**" of the highest grade of a quality assurance program at the choice of a customer. Each quality grade is designed for applications described below. Any customer who intends to use a product for application other than that of Standard quality grade is required to contact an NEC sales representative in advance.

The **Standard** quality grade applies to the products developed, designed and manufactured in accordance with the NEC standard quality assurance program, which are designed for such application as any failure or malfunction of the products (sets) or parts/components incorporated therein a customer uses are, directly or indirectly, free of any damage to death, human bodily injury or other property, like general electronic devices.

Examples: Computers, office automation equipment, communications equipment, test and measurement equipment, audio and visual equipment, home electronic appliances, machine tools, personal electronic equipment, industrial robots, etc.

The **Special** quality grade applies to the products developed, designed and manufactured in accordance with an NEC quality assurance program stricter than the standard one, which are designed for such application as any failure or malfunction of the products (sets) or parts/components incorporated therein a customer uses might directly cause any damage to death, human bodily injury or other property, or such application under more severe condition than that defined in the Standard quality grade without such direct damage.

Examples: Control systems for transportation equipment (automobiles, trains, ships, etc.), traffic control systems, anti-disaster systems, anti-crime systems, medical equipment not specifically designed for life support, safety equipment, etc.

The **Specific** quality grade applies to the products developed, designed and manufactured in accordance with the standards or quality assurance program designated by a customer who requires an extremely higher level of reliability and quality for such products.

Examples: Military systems, aircraft control equipment, aerospace equipment, nuclear reactor control systems, medical equipment/devices/systems for life support, etc.

The quality grade of this product is the "**Standard**" unless otherwise specified in this document.

**CONTENTS**

**INTRODUCTION ..... 2**

**1. OUTLINE..... 4**

    1.1 STRUCTURE AND PRINCIPLE..... 4

    1.2 APPLICATION..... 4

    1.3 FEATURES..... 4

**2. GENERAL SPECIFICATIONS ..... 5**

**3. BLOCK DIAGRAM..... 6**

**4. DETAILED SPECIFICATIONS ..... 7**

    4.1 MECHANICAL SPECIFICATIONS..... 7

    4.2 ABSOLUTE MAXIMUM RATINGS ..... 7

    4.3 ELECTRICAL CHARACTERISTICS..... 8

        4.3.1 LCD panel signal processing board..... 8

        4.3.2 Backlight lamp..... 9

        4.3.3 Power supply voltage ripple..... 10

        4.3.4 Fuse..... 10

    4.4 POWER SUPPLY VOLTAGE SEQUENCE ..... 11

    4.5 CONNECTIONS AND FUNCTIONS FOR INTERFACE PINS..... 12

        4.5.1 LCD panel signal processing board..... 12

        4.5.2 Backlight lamp..... 14

        4.5.3 Positions of plug and socket ..... 16

    4.6 METHOD OF CONNECTION FOR LVDS TRANSMITTER..... 17

    4.7 DISPLAY GRAY SCALE AND INPUT DATA SIGNALS..... 19

    4.8 INPUT SIGNAL TIMINGS..... 20

        4.8.1 Timing characteristics..... 20

        4.8.2 Input signal timing chart..... 20

    4.9 LVDS DATA TRANSMISSION METHOD ..... 21

    4.10 DISPLAY POSITIONS..... 21

    4.11 PIXEL ARRANGMENT..... 22

    4.12 TEN-bit LOOK UP TABLE FOR GAMMA ADJUSTMENT..... 23

    4.13 LUT SERIAL COMMUNICATION TIMINGS..... 26

    4.14 OPTICS..... 28

        4.14.1 Optical characteristics..... 28

        4.14.2 Definition of contrast ratio..... 30

        4.14.3 Definition of luminance uniformity..... 30

        4.14.4 Definition of response times..... 30

        4.14.5 Definition of viewing angles..... 30

**5. RELIABILITY TESTS..... 31**

**6. PRECAUTIONS ..... 32**

    6.1 MEANING OF CAUTION SIGNS ..... 32

    6.2 CAUTIONS ..... 32

    6.3 ATTENTIONS ..... 32

        6.3.1 Handling of the product..... 32

        6.3.2 Environment..... 33

        6.3.3 Characteristics..... 33

        6.3.4 Other ..... 33

**7. OUTLINE DRAWINGS ..... 34**

    7.1 FRONT VIEW ..... 34

    7.2 REAR VIEW ..... 35

**1. OUTLINE**

**1.1 STRUCTURE AND PRINCIPLE**

Monochrome LCD module NL204153BM21-01 and NL204153BM21-01A are composed of the amorphous silicon thin film transistor liquid crystal display (a-Si TFT LCD) panel structure with driver LSIs for driving the TFT (Thin Film Transistor) array and a backlight.

The a-Si TFT LCD panel structure is injected liquid crystal material into a narrow gap between the TFT array glass substrate and a monochrome-filter glass substrate.

Grayscale data signals from a host system (e.g. signal generator, etc.) are modulated into best form for active matrix system by a signal processing board, and sent to the driver LSIs which drive the individual TFT arrays.

The TFT array as an electro-optical switch regulates the amount of transmitted light from the backlight assembly, when it is controlled by data signals. Monochrome images are created by regulating the amount of transmitted light through the TFT array.

**1.2 APPLICATION**

- Monochrome monitor system

**1.3 FEATURES**

- Ultra-wide viewing angle (Adoption of Super - Advanced Super Fine TFT (SA-SFT))
- High luminance
- High contrast
- Low reflection
- High resolution
- 256 gray scales per 1 sub-pixel
- LVDS interface
- Adjustable gamma characteristics by using built-in 10-bit LUT (look up table)
- Selectable LVDS data input map
- Small foot print
- Incorporated edge light type backlight (without inverter)
- Replaceable backlight
- Differences between NL204153BM21-01 and NL204153BM21-01A

Item	NL204153BM21-01	NL204153BM21-01A
White chromaticity	W <sub>x</sub> , W <sub>y</sub> = (0.255, 0.310) (typ.)	W <sub>x</sub> , W <sub>y</sub> = (0.280, 0.304) (typ.)
Luminance	700cd/m <sup>2</sup> (min.)	650cd/m <sup>2</sup> (min.)
Backlight unit (Replaceable part)	213LHS06	213LHS11
Cable color of backlight lamps	See "4.5.2 Backlight lamp".	

**2. GENERAL SPECIFICATIONS**

<b>Display area</b>	433.152 (H) × 324.864 (V) mm	
<b>Diagonal size of display</b>	54 cm (21.3 inches)	
<b>Drive system</b>	a-Si TFT active matrix	
<b>Display grayscale</b>	256 gray scales per 1 sub-pixel (8-bit) (766 gray scales per 1 pixel)	
<b>Pixel</b>	2,048 (H) × 1,536 (V) pixels (1 pixel consists of 3 sub-pixels (LCR).)	
<b>Pixel arrangement</b>	LCR vertical stripe	
<b>Sub-pixel pitch</b>	0.0705 (H) × 0.2115 (V) mm	
<b>Pixel pitch</b>	0.2115 (H) × 0.2115 (V) mm	
<b>Module size</b>	457.0 (W) × 350.0 (H) × 25.0 (D) mm (typ.)	
<b>Weight</b>	3,800 g (typ.)	
<b>Contrast ratio</b>	700:1 (typ.)	
<b>Viewing angle</b>	<i>At the contrast ratio ≥ 10:1</i> <ul style="list-style-type: none"> <li>• Horizontal: Right side 85° (typ.), Left side 85° (typ.)</li> <li>• Vertical: Up side 85° (typ.), Down side 85° (typ.)</li> </ul>	
<b>Designed viewing direction</b>	Viewing angle with optimum grayscale ( $\gamma$ =DICOM): Normal axis (perpendicular) Note1	
<b>Polarizer surface</b>	Antiglare	
<b>Polarizer pencil-hardness</b>	2H (min.) [by JIS K5400]	
<b>Response time</b>	<i>Ton + Toff (10% ← → 90%)</i> 35 ms (typ.)	
<b>Luminance</b>	<i>At IBL = 6.0mArms / lamp</i> 800 cd/m <sup>2</sup> (typ.)	
<b>White chromaticity</b>	NL204153BM21-01	W <sub>x</sub> , W <sub>y</sub> = (0.255, 0.310) (typ.)
	NL204153BM21-01A	W <sub>x</sub> , W <sub>y</sub> = (0.280, 0.304) (typ.)
<b>Signal system</b>	4 ports LVDS interface (THC63LVD824×2 pcs, Thine Electronics, Inc. or equivalent) [LCR 8-bit signals, Data enable signal (DE), Dot clock (CLK)]	
<b>Power supply voltage</b>	LCD panel signal processing board: 12.0V	
<b>Backlight</b>	Edge light type: 6 cold cathode fluorescent lamps (without inverter) (Replaceable part • Backlight unit: Type No. 213LHS06 for NL204153BM21-01 213LHS11 for NL204153BM21-01A)	
<b>Power consumption</b>	<i>At IBL = 6.0mArms/lamp, Checkered flag pattern</i> 34.2 W (typ., Power dissipation of the inverter is not included.)	

Note1: When the product luminance is 800cd/m<sup>2</sup>, the gamma characteristic is designed to  $\gamma$ =DICOM.

3. BLOCK DIAGRAM

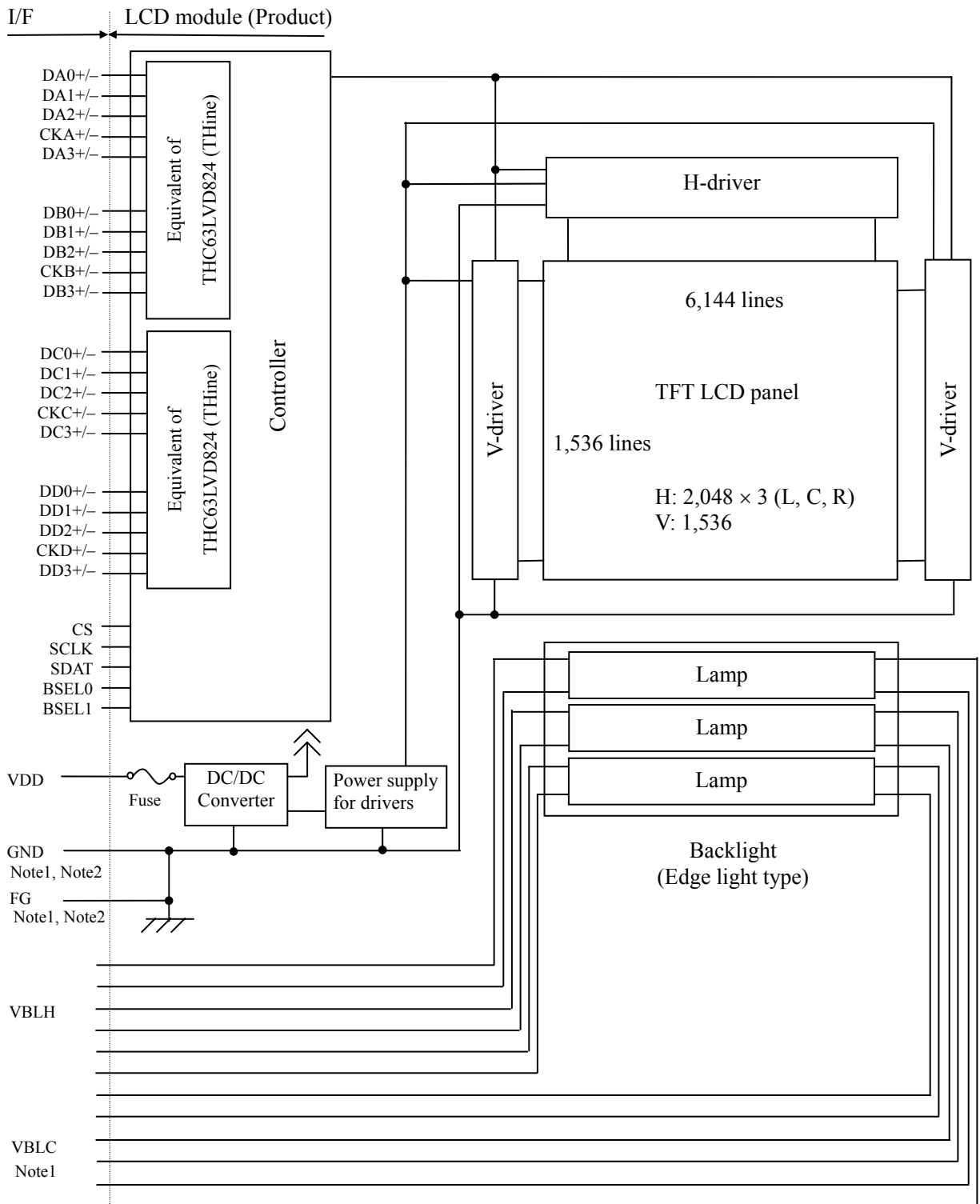

Note1: Connections between GND (Signal ground), FG (Frame ground) and VBLC (Lamp low voltage terminal) in the LCD module

GND - FG	Connected
GND - VBLC	Not connected
FG - VBLC	Not connected

Note2: GND and FG must be connected to customer equipment's ground, and it is recommended that GND, FG and customer inverter ground are connected together in customer equipment.

**4. DETAILED SPECIFICATIONS**

**4.1 MECHANICAL SPECIFICATIONS**

Parameter	Specification	Unit
Module size	457.0 ± 0.5 (W) × 350.0 ± 0.5 (H) × 25.0 ± 0.5 (D)      Note1, Note2	mm
Display area	433.152 (H) × 324.864 (V)      Note2	mm
Weight	3,800 (typ.), 4,000 (max.)	g

Note1: Excluding warpage of the signal processing board cover and the connection board cover.

Note2: See "7. OUTLINE DRAWINGS".

**4.2 ABSOLUTE MAXIMUM RATINGS**

Parameter		Symbol	Rating	Unit	Remarks
Power supply voltage	LCD panel signal processing board	VDD	-0.3 to +14.0	V	Ta = 25°C
	Lamp voltage	VBLH	2,000	Vrms	
Input signal voltage Note1		Vi	-0.3 to +2.8	V	Ta = 25°C VDD=12.0V
Storage temperature		Tst	-20 to +60	°C	-
Operating temperature	Front surface	TopF	0 to +55	°C	Note2
	Rear surface	TopR	0 to +60	°C	Note3
-Relative humidity Note4		RH	≤ 70	%	Ta ≤ 55°C
Absolute humidity Note4		AH	≤ 73 Note5	g/m <sup>3</sup>	Ta > 55°C

Note1: DA0+/-, DA1+/-, DA2+/-, DA3+/-, CKA+/-, DB0+/-, DB1+/-, DB2+/-, DB3+/-, CKB+/-, DC0+/-, DC1+/-, DC2+/-, DC3+/-, CKC+/-, DD0+/-, DD1+/-, DD2+/-, DD3+/-, CKD+/-, CS, SCLK, SDAT, BSEL0, BSEL1

Note2: Measured at center of LCD panel surface (including self-heat)

Note3: Measured at center of LCD module's rear shield surface (including self-heat)

Note4: No condensation

Note5: Water amount at Ta = 55°C and RH = 70%

4.3 ELECTRICAL CHARACTERISTICS

4.3.1 LCD panel signal processing board

(Ta = 25°C)

Parameter	Symbol	min.	typ.	max.	Unit	Remarks	
Supply voltage	VDD	10.8	12.0	13.2	V	-	
Supply current	IDD	-	600 Note1	1,100 Note2	mA	at VDD=12.0V	
Ripple voltage	VRP	-	-	100	mVp-p	for VDD	
Differential input threshold voltage	High	VTH	-	-	+100	mV	at VCM= 1.2V Note3, Note4
	Low	VTL	-100	-	-	mV	
Input voltage swing	VI	0	-	2.4	V	Note4	
Terminating resistance	RT	-	100	-	Ω	-	
Control signal input threshold voltage	High	VIH	Keep this pin open.			-	Note5
	Low	VIL	0	-	0.5	V	
Control signal input current	Low	IIL	-10	-	10	μA	
Serial communication signal input threshold voltage	High	V+	-	1.4	1.9	V	Note6
	Low	V-	0.4	0.7	-	V	
	Hysteresis	VH	0.3	-	-	V	

Note1: Checkered flag pattern (by EIAJ ED-2522)

Note2: Pattern for maximum current

Note3: Common mode voltage for LVDS driver

Note4: DA0+/-, DA1+/-, DA2+/-, DA3+/-, CKA+/-, DB0+/-, DB1+/-, DB2+/-, DB3+/-, CKB+/-, DC0+/-, DC1+/-, DC2+/-, DC3+/-, CKC+/-, DD0+/-, DD1+/-, DD2+/-, DD3+/-, CKD+/-

Note5: BSEL0, BSEL1

Note6: CS, SCLK, SDAT



4.3.2 Backlight lamp

(Ta=25°C, Note1)

Parameter	Symbol	min.	typ.	max.	Unit	Remarks
Lamp current	IBL	3.0	6.0	7.0	mArms	at IBL= 6.0mArms: 800 cd/m <sup>2</sup> Note3
Lamp voltage	VBLH	-	750	-	Vrms	Note2, Note3
Lamp starting voltage	VS	1,220	-	-	Vrms	Ta = 25°C Note2, Note3
		1,460	-	-	Vrms	Ta = 0°C Note2, Note3
Lamp oscillation frequency	FO	50	58	60	kHz	Note4

Note1: This product consists of 6 backlight lamps, and these specifications are for each lamp.

Note2: The lamp voltage cycle between lamps should be kept on a same phase. "VS" and "VBLH" are the voltage value between low voltage side (Cold) and high voltage side (Hot).

Note3: The asymmetric ratio of working waveform for lamps (Lamp voltage peak ratio, Lamp current peak ratio and waveform space ratio) should be less than 5 % (See the following figure.). If the waveform is asymmetric, DC (Direct current) element apply into the lamp. In this case, a lamp lifetime may be shortened, because a distribution of a lamp enclosure substance inclines toward one side between low voltage terminal (Cold terminal) and high voltage terminal (Hot terminal). When designing the inverter, evaluate asymmetric of lamp working waveform sufficiently.

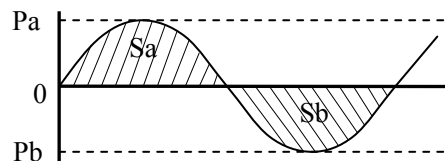

$$\frac{|Pa - Pb|}{Pb} \times 100 \leq 5 \%$$

$$\frac{|Sa - Sb|}{Sb} \times 100 \leq 5 \%$$

Pa: Supply voltage/current peak for positive, Pb: Supply voltage/current peak for negative  
Sa: Waveform space for positive part, Sb: Waveform space for negative part.

Note4: A beat noise by interference of "FO" and "1/th" may appear on the screen. (th: Horizontal cycle (See "4.8.1 Timing characteristics".)) Set up the "FO" so that the beat noise does not appear.

Note5: Method of lamp cable installation may invite fluctuation of lamp current and voltage or asymmetric of lamp working waveform. When designing method of lamp cable installation, evaluate the fluctuation of lamp current, voltage and working waveform sufficiently.

4.3.3 Power supply voltage ripple

This product works, even if the ripple voltage levels are beyond the permissible values as following the table, but there might be noise on the display image.

Power supply voltage		Ripple voltage (Measure at input terminal of power supply)	Note1	Unit
VDD	12.0 V	≤ 100		mVp-p

Note1: The permissible ripple voltage includes spike noise.

4.3.4 Fuse

Parameter	Fuse		Rating	Fusing current	Remarks
	Type	Supplier			
VDD	FCC16202AB	KAMAYA ELECTRIC Co., Ltd.	2.0 A	4.0 A, 5s max.	Note1
			32 V		

Note1: The power supply capacity should be more than the fusing current. If it is less than the fusing current, the fuse may not blow in a short time, and then nasty smell, smoke and so on may occur.

4.4 POWER SUPPLY VOLTAGE SEQUENCE

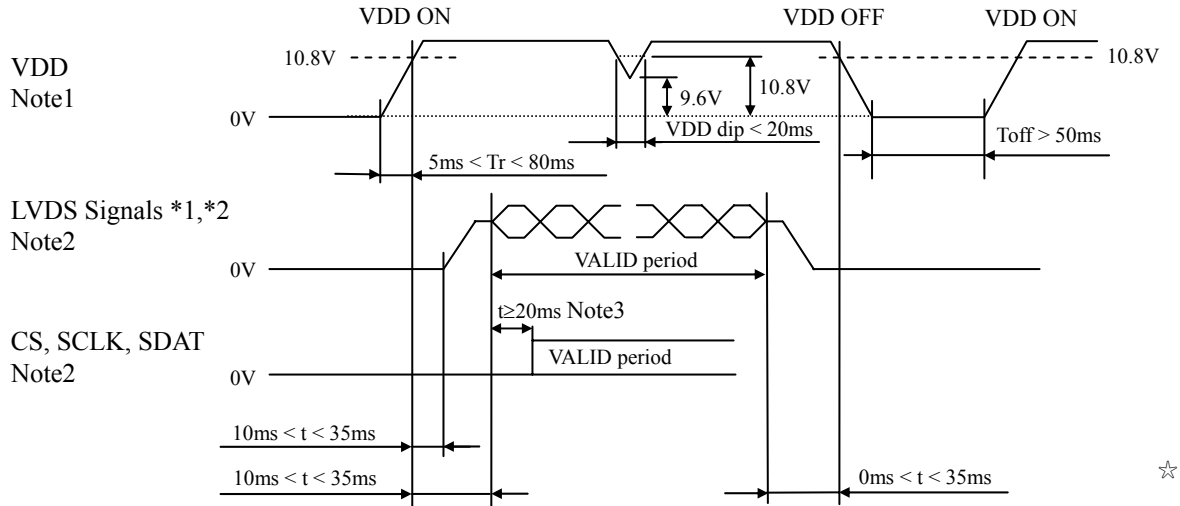

- \*1: DA0+/-, DA1+/-, DA2+/-, DA3+/-, CKA+/-, DB0+/-, DB1+/-, DB2+/-, DB3+/-, CKB+/-, DC0+/-, DC1+/-, DC2+/-, DC3+/-, CKC+/-, DD0+/-, DD1+/-, DD2+/-, DD3+/-, CKD+/-
- \*2: LVDS signals should be measured at the terminal of 100Ω resistance.

Note1: In terms of voltage variation (voltage drop) while VDD rising edge is below 10.8V, a protection circuit may work, and then this product may not work.

Note2: LVDS signals and CS, SCLK, SDAT must be Low or High-impedance, exclude the VALID period (See above sequence diagram), in order to avoid that internal circuits is damaged. ☆  
 If some of signals are cut while this product is working, even if the signal input to it once again, it might not work normally. VDD should be cut when the display and function signals are stopped.

Note3: At the beginning of the serial communication mode, take 20ms or more after the LVDS signal input. When writing the LUT data, see “4.12 TEN-bit LOOK UP TABLE FOR GAMMA ADJUSTMENT”.

Note4: The backlight should be turned on within the valid period of display and function signals, in order to avoid unstable data display. ☆

4.5 CONNECTIONS AND FUNCTIONS FOR INTERFACE PINS

4.5.1 LCD panel signal processing board

CN1 socket (LCD module side): FI-WE41P-HFE (Japan Aviation Electronics Industry Limited (JAE)) ☆

Adaptable plug: FI-W41S (Japan Aviation Electronics Industry Limited (JAE))

Pin No.	Symbol	Signal	Remarks															
1	RSVD1	Reserved	Connect to signal ground.															
2	N.C.	-	Keep this pin Open.															
3	CS	Chip selection (Pull-up 25kΩ)	LUT communication control signal See "4.12 TEN-bit LOOK UP TABLE FOP GAMMA ADJUSTMENT".															
4	SCLK	Serial Clock (Pull-down 25kΩ)																
5	SDAT	Serial Data (Pull-down 25kΩ)																
6	RSVD2	Reserved	Keep this pin Open.															
7																		
8	BSEL0	Selection of LVDS data input map (Pull-up 25kΩ)	See "4.6 METHOD OF CONNECTION FOR LVDS TRANSMITTER". <table border="1" style="margin-left: auto; margin-right: auto;"> <thead> <tr> <th>BSEL0</th> <th>BSEL1</th> <th>Mode</th> </tr> </thead> <tbody> <tr> <td>Open</td> <td>Open</td> <td>A</td> </tr> <tr> <td>Open</td> <td>Low</td> <td>B</td> </tr> <tr> <td>Low</td> <td>Open</td> <td>C</td> </tr> <tr> <td>Low</td> <td>Low</td> <td>A</td> </tr> </tbody> </table>	BSEL0	BSEL1	Mode	Open	Open	A	Open	Low	B	Low	Open	C	Low	Low	A
BSEL0	BSEL1			Mode														
Open	Open			A														
Open	Low			B														
Low	Open	C																
Low	Low	A																
9	BSEL1																	
10	RSVD2	Reserved	Keep this pin Open.															
11	GND	Signal ground	Note1															
12	DB3+	Pixel data B3	LVDS differential data input															
13	DB3-			Note2														
14	GND	Signal ground	Note1															
15	CKB+	Pixel clock B	LVDS differential clock input															
16	CKB-			Note2														
17	GND	Signal ground	Note1															
18	DB2+	Pixel data B2	LVDS differential data input															
19	DB2-			Note2														
20	GND	Signal ground	Note1															
21	DB1+	Pixel data B1	LVDS differential data input															
22	DB1-			Note2														
23	GND	Signal ground	Note1															
24	DB0+	Pixel data B0	LVDS differential data input															
25	DB0-			Note2														
26	GND	Signal ground	Note1															
27	DA3+	Pixel data A3	LVDS differential data input															
28	DA3-			Note2														
29	GND	Signal ground	Note1															
30	CKA+	Pixel clock A	LVDS differential clock input															
31	CKA-			Note2														
32	GND	Signal ground	Note1															
33	DA2+	Pixel data A2	LVDS differential data input															
34	DA2-			Note2														
35	GND	Signal ground	Note1															
36	DA1+	Pixel data A1	LVDS differential data input															
37	DA1-			Note2														
38	GND	Signal ground	Note1															
39	DA0+	Pixel data A0	LVDS differential data input															
40	DA0-			Note2														
41	GND	Signal ground	Note1															

Note1: All GND terminals should be used without any non-connected lines.

Note2: Twist pair wires with 100Ω (Characteristic impedance) should be used between LCD panel signal processing board and LVDS transmitter.

☆

CN2 socket (LCD module side): FI-WE31P-HFE (Japan Aviation Electronics Industry Limited (JAE))  
 Adaptable plug: FI-W31S (Japan Aviation Electronics Industry Limited (JAE))

☆

Pin No.	Symbol	Signal	Remarks
1	GND	Signal ground	Note1
2	DD3+	Pixel data D3	LVDS differential data input Note2
3	DD3-		
4	GND	Signal ground	Note1
5	CKD+	Pixel clock D	LVDS differential clock input Note2
6	CKD-		
7	GND	Signal ground	Note1
8	DD2+	Pixel data D2	LVDS differential data input Note2
9	DD2-		
10	GND	Signal ground	Note1
11	DD1+	Pixel data D1	LVDS differential data input Note2
12	DD1-		
13	GND	Signal ground	Note1
14	DD0+	Pixel data D0	LVDS differential data input Note2
15	DD0-		
16	GND	Signal ground	Note1
17	DC3+	Pixel data C3	LVDS differential data input Note2
18	DC3-		
19	GND	Signal ground	Note1
20	CKC+	Pixel clock C	LVDS differential clock input Note2
21	CKC-		
22	GND	Signal ground	Note1
23	DC2+	Pixel data C2	LVDS differential data input Note2
24	DC2-		
25	GND	Signal ground	Note1
26	DC1+	Pixel data C1	LVDS differential data input Note2
27	DC1-		
28	GND	Signal ground	Note1
29	DC0+	Pixel data C0	LVDS differential data input Note2
30	DC0-		
31	GND	Signal ground	Note1

Note1: All GND terminals should be used without any non-connected lines.

Note2: Twist pair wires with 100Ω (Characteristic impedance) should be used between LCD panel signal processing board and LVDS transmitter.

☆

CN3 socket (LCD module side): IL-Z-8PL-SMTYE (Japan Aviation Electronics Industry Limited (JAE))  
 Adaptable plug: IL-Z-8S-S125C (Japan Aviation Electronics Industry Limited (JAE))

☆

Pin No.	Symbol	Function	Description
1	VDD	Power supply	Note1
2	VDD		
3	VDD		
4	VDD		
5	GND	Signal ground	Note1
6	GND		
7	GND		
8	GND		

Note1: All VDD and GND terminals should be used without any non-connected lines.

4.5.2 Backlight lamp

**Attention: VBLH and VBLC must be connected correctly. Wrong connections will cause electric shock and also break down of the product.**

(1) NL204153BM21-01

CN201 plug (LCD module side): BHSR-02VS-1 (J.S.T. Mfg Co., Ltd.)

Adaptable socket: SM02B-BHSS-1-TB(LF)(SN),  
SM02B-BHSS-1-TB (J.S.T. Mfg Co., Ltd.)

☆

Pin No.	Symbol	Function	Remarks
1	VBLH1	Upper side lamp, High voltage (Hot)	Cable color: Pink
2	VBLC1	Upper side lamp, Low voltage (Cold)	Cable color: Gray

CN202 plug (LCD module side): BHSR-02VS-1 (J.S.T. Mfg Co., Ltd.)

Adaptable socket: SM02B-BHSS-1-TB(LF)(SN),  
SM02B-BHSS-1-TB (J.S.T. Mfg Co., Ltd.)

☆

Pin No.	Symbol	Function	Remarks
1	VBLH2	Upper side lamp, High voltage (Hot)	Cable color: White
2	VBLC2	Upper side lamp, Low voltage (Cold)	Cable color: Gray

CN203 plug (LCD module side): BHSR-02VS-1 (J.S.T. Mfg Co., Ltd.)

Adaptable socket: SM02B-BHSS-1-TB(LF)(SN),  
SM02B-BHSS-1-TB (J.S.T. Mfg Co., Ltd.)

☆

Pin No.	Symbol	Function	Remarks
1	VBLH3	Upper side lamp, High voltage (Hot)	Cable color: Blue
2	VBLC3	Upper side lamp, Low voltage (Cold)	Cable color: Gray

CN204 plug (LCD module side): BHSR-02VS-1 (J.S.T. Mfg Co., Ltd.)

Adaptable socket: SM02B-BHSS-1-TB(LF)(SN),  
SM02B-BHSS-1-TB (J.S.T. Mfg Co., Ltd.)

☆

Pin No.	Symbol	Function	Remarks
1	VBLH4	Lower side lamp, High voltage (Hot)	Cable color: Pink
2	VBLC4	Lower side lamp, Low voltage (Cold)	Cable color: Gray

CN205 plug (LCD module side): BHSR-02VS-1 (J.S.T. Mfg Co., Ltd.)

Adaptable socket: SM02B-BHSS-1-TB(LF)(SN),  
SM02B-BHSS-1-TB (J.S.T. Mfg Co., Ltd.)

☆

Pin No.	Symbol	Function	Remarks
1	VBLH5	Lower side lamp, High voltage (Hot)	Cable color: White
2	VBLC5	Lower side lamp, Low voltage (Cold)	Cable color: Gray

CN206 plug (LCD module side): BHSR-02VS-1 (J.S.T. Mfg Co., Ltd.)

Adaptable socket: SM02B-BHSS-1-TB(LF)(SN),  
SM02B-BHSS-1-TB (J.S.T. Mfg Co., Ltd.)

☆

Pin No.	Symbol	Function	Remarks
1	VBLH6	Lower side lamp, High voltage (Hot)	Cable color: Blue
2	VBLC6	Lower side lamp, Low voltage (Cold)	Cable color: Gray

(2) NL204153BM21-01A

CN201 plug (LCD module side): BHSR-02VS-1 (J.S.T. Mfg Co., Ltd.)

Adaptable socket: SM02B-BHSS-1-TB(LF)(SN),  
SM02B-BHSS-1-TB (J.S.T. Mfg Co., Ltd.)

☆

Pin No.	Symbol	Function	Remarks
1	VBLH1	Upper side lamp, High voltage (Hot)	Cable color: Red
2	VBLC1	Upper side lamp, Low voltage (Cold)	Cable color: Gray

CN202 plug (LCD module side): BHSR-02VS-1 (J.S.T. Mfg Co., Ltd.)

Adaptable socket: SM02B-BHSS-1-TB(LF)(SN),  
SM02B-BHSS-1-TB (J.S.T. Mfg Co., Ltd.)

☆

Pin No.	Symbol	Function	Remarks
1	VBLH2	Upper side lamp, High voltage (Hot)	Cable color: White
2	VBLC2	Upper side lamp, Low voltage (Cold)	Cable color: Gray

CN203 plug (LCD module side): BHSR-02VS-1 (J.S.T. Mfg Co., Ltd.)

Adaptable socket: SM02B-BHSS-1-TB(LF)(SN),  
SM02B-BHSS-1-TB (J.S.T. Mfg Co., Ltd.)

☆

Pin No.	Symbol	Function	Remarks
1	VBLH3	Upper side lamp, High voltage (Hot)	Cable color: Blue
2	VBLC3	Upper side lamp, Low voltage (Cold)	Cable color: Gray

CN204 plug (LCD module side): BHSR-02VS-1 (J.S.T. Mfg Co., Ltd.)

Adaptable socket: SM02B-BHSS-1-TB(LF)(SN),  
SM02B-BHSS-1-TB (J.S.T. Mfg Co., Ltd.)

☆

Pin No.	Symbol	Function	Remarks
1	VBLH4	Lower side lamp, High voltage (Hot)	Cable color: Red
2	VBLC4	Lower side lamp, Low voltage (Cold)	Cable color: Gray

CN205 plug (LCD module side): BHSR-02VS-1 (J.S.T. Mfg Co., Ltd.)

Adaptable socket: SM02B-BHSS-1-TB(LF)(SN),  
SM02B-BHSS-1-TB (J.S.T. Mfg Co., Ltd.)

☆

Pin No.	Symbol	Function	Remarks
1	VBLH5	Lower side lamp, High voltage (Hot)	Cable color: White
2	VBLC5	Lower side lamp, Low voltage (Cold)	Cable color: Gray

CN206 plug (LCD module side): BHSR-02VS-1 (J.S.T. Mfg Co., Ltd.)

Adaptable socket: SM02B-BHSS-1-TB(LF)(SN),  
SM02B-BHSS-1-TB (J.S.T. Mfg Co., Ltd.)

☆

Pin No.	Symbol	Function	Remarks
1	VBLH6	Lower side lamp, High voltage (Hot)	Cable color: Blue
2	VBLC6	Lower side lamp, Low voltage (Cold)	Cable color: Gray

4.5.3 Positions of plug and socket

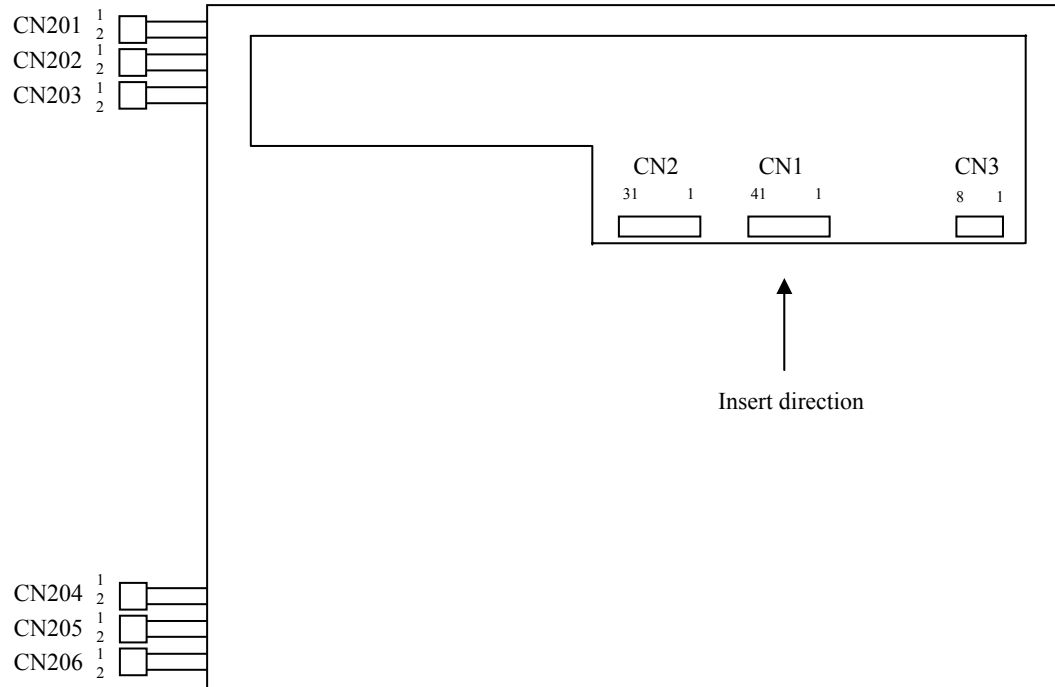



4.6 METHOD OF CONNECTION FOR LVDS TRANSMITTER

LVDS data input map is selectable by BSEL0 and BSEL1 terminal.

	Bit mapping			Transmitter Pin Assignment			Output Connector	CN1				
	BSEL[1 0] Note1			Single type LVDS Tx	Dual type LVDS TX			Pin No	Signal name			
	[H:H], [L:L] Mode A	[H L] Mode B	[L H] Mode C		THine THC63LVD823	NS DS90C387						
Pixel data A	LA2	LA7	LA0	TA0	R12	R10	ATA- ATA+	→ →	40 39	DA0- DA0+		
	LA3	LA6	LA1	TA1	R13	R11						
	LA4	LA5	LA2	TA2	R14	R12						
	LA5	LA4	LA3	TA3	R15	R13						
	LA6	LA3	LA4	TA4	R16	R14						
	LA7	LA2	LA5	TA5	R17	R15						
	Note3	CA2	CA7	CA0	TA6	G12	G10	ATB- ATB+	→ →	37 36	DA1- DA1+	
		CA3	CA6	CA1	TB0	G13	G11					
		CA4	CA5	CA2	TB1	G14	G12					
		CA5	CA4	CA3	TB2	G15	G13					
		CA6	CA3	CA4	TB3	G16	G14					
		CA7	CA2	CA5	TB4	G17	G15					
		Note3	RA2	RA7	RA0	TB5	B12	B10	ATC- ATC+	→ →	34 33	DA2- DA2+
			RA3	RA6	RA1	TB6	B13	B11				
			RA4	RA5	RA2	TC0	B14	B12				
			RA5	RA4	RA3	TC1	B15	B13				
			RA6	RA3	RA4	TC2	B16	B14				
			RA7	RA2	RA5	TC3	B17	B15				
Note3			RSVD	RSVD	RSVD	TC4	HSYNC	HSYNC	ATD- ATD+	→ →	28 27	DA3- DA3+
			RSVD	RSVD	RSVD	TC5	VSYNC	VSYNC				
			DE	DE	DE	TC6	DE	DE				
			LA0	LA1	LA6	TD0	R10	R16				
			LA1	LA0	LA7	TD1	R11	R17				
			CA0	CA1	CA6	TD2	G10	G16				
	Note3		CA1	CA0	CA7	TD3	G11	G17	ATCLK- ATCLK+	→ →	31 30	CKA- CKA+
			RA0	RA1	RA6	TD4	B10	B16				
			RA1	RA0	RA7	TD5	B11	B17				
			N C	N C	N C	TD6	-	-				
			CLK	CLK	CLK	CLK	CLK	CLK				
			LB2	LB7	LB0	TA0	R22	R20				
		LB3	LB6	LB1	TA1	R23	R21					
		LB4	LB5	LB2	TA2	R24	R22					
		LB5	LB4	LB3	TA3	R25	R23					
		LB6	LB3	LB4	TA4	R26	R24					
		LB7	LB2	LB5	TA5	R27	R25					
		Pixel data B	CB2	CB7	CB0	TA6	G22	G20	BTB- BTB+	→ →	22 21	DB1- DB1+
CB3			CB6	CB1	TB0	G23	G21					
CB4			CB5	CB2	TB1	G24	G22					
CB5			CB4	CB3	TB2	G25	G23					
CB6			CB3	CB4	TB3	G26	G24					
CB7			CB2	CB5	TB4	G27	G25					
Note3			RB2	RB7	RB0	TB5	B22	B20	BTC- BTC+	→ →	19 18	DB2- DB2+
	RB3		RB6	RB1	TB6	B23	B21					
	RB4		RB5	RB2	TC0	B24	B22					
	RB5		RB4	RB3	TC1	B25	B23					
	RB6		RB3	RB4	TC2	B26	B24					
	RB7		RB2	RB5	TC3	B27	B25					
	Note3		RSVD	RSVD	RSVD	TC4	HSYNC	HSYNC	BTD- BTD+	→ →	13 12	DB3- DB3+
			RSVD	RSVD	RSVD	TC5	VSYNC	VSYNC				
			DE	DE	DE	TC6	DE	DE				
			LB0	LB1	LB6	TD0	R20	R26				
			LB1	LB0	LB7	TD1	R21	R27				
			CB0	CB1	CB6	TD2	G20	G26				
		Note3	CB1	CB0	CB7	TD3	G21	G27	BTCLK- BTCLK+	→ →	16 15	CKB- CKB+
			RB0	RB1	RB6	TD4	B20	B26				
			RB1	RB0	RB7	TD5	B21	B27				
			N C	N C	N C	TD6	-	-				
			CLK	CLK	CLK	CLK	CLK	CLK				
			LB2	LB7	LB0	TA0	R22	R20				
LB3			LB6	LB1	TA1	R23	R21					
LB4			LB5	LB2	TA2	R24	R22					
LB5			LB4	LB3	TA3	R25	R23					
LB6			LB3	LB4	TA4	R26	R24					
LB7			LB2	LB5	TA5	R27	R25					
CB2			CB7	CB0	TA6	G22	G20					
CB3	CB6		CB1	TB0	G23	G21						
CB4	CB5		CB2	TB1	G24	G22						
CB5	CB4		CB3	TB2	G25	G23						
CB6	CB3		CB4	TB3	G26	G24						
CB7	CB2		CB5	TB4	G27	G25						
RB2	RB7		RB0	TB5	B22	B20						
RB3	RB6	RB1	TB6	B23	B21							
RB4	RB5	RB2	TC0	B24	B22							
RB5	RB4	RB3	TC1	B25	B23							
RB6	RB3	RB4	TC2	B26	B24							
RB7	RB2	RB5	TC3	B27	B25							
RSVD	RSVD	RSVD	TC4	HSYNC	HSYNC							
RSVD	RSVD	RSVD	TC5	VSYNC	VSYNC							
DE	DE	DE	TC6	DE	DE							
LB0	LB1	LB6	TD0	R20	R26							
LB1	LB0	LB7	TD1	R21	R27							
CB0	CB1	CB6	TD2	G20	G26							
CB1	CB0	CB7	TD3	G21	G27							
RB0	RB1	RB6	TD4	B20	B26							
RB1	RB0	RB7	TD5	B21	B27							
N C	N C	N C	TD6	-	-							
CLK	CLK	CLK	CLK	CLK	CLK							

	BSEL[1 0] Note1			Single type LVDS Tx	Dual type LVDS TX		Output Connector	CN2		
	[H:H], [L:L] Mode A	[H L] Mode B	[L H] Mode C		THine THC63LVD823	NS DS90C387		Pin No	Signal name	
Pixel data C	LC2	LC7	LC0	TA0	R12	R10	CTA- CTA+	→ →		
	LC3	LC6	LC1	TA1	R13	R11				
	LC4	LC5	LC2	TA2	R14	R12				
	LC5	LC4	LC3	TA3	R15	R13				
	LC6	LC3	LC4	TA4	R16	R14				
	LC7	LC2	LC5	TA5	R17	R15				
	CC2	CC7	CC0	TA6	G12	G10	CTB- CTB+	→ →		
	CC3	CC6	CC1	TB0	G13	G11				
	CC4	CC5	CC2	TB1	G14	G12				
	CC5	CC4	CC3	TB2	G15	G13				
	CC6	CC3	CC4	TB3	G16	G14				
	CC7	CC2	CC5	TB4	G17	G15				
	Note3	RC2	RC7	RC0	TB5	B12	B10	CTC- CTC+	→ →	
		RC3	RC6	RC1	TB6	B13	B11			
		RC4	RC5	RC2	TC0	B14	B12			
		RC5	RC4	RC3	TC1	B15	B13			
		RC6	RC3	RC4	TC2	B16	B14			
		RC7	RC2	RC5	TC3	B17	B15			
RSVD		RSVD	RSVD	TC4	HSYNC	HSYNC	CTD- CTD+	→ →		
RSVD		RSVD	RSVD	TC5	VSYNC	VSYNC				
DE		DE	DE	TC6	DE	DE				
LC0		LC1	LC6	TD0	R10	R16				
LC1		LC0	LC7	TD1	R11	R17				
CC0		CC1	CC6	TD2	G10	G16				
CC1	CC0	CC7	TD3	G11	G17	CTCLK- CTCLK+	→ →			
RC0	RC1	RC6	TD4	B10	B16					
RC1	RC0	RC7	TD5	B11	B17					
N C	N C	N C	TD6	-	-					
CLK	CLK	CLK	CLK	CLK	CLK					
Pixel data D	LD2	LD7	LD0	TA0	R22	R20	DTA- DTA+	→ →		
	LD3	LD6	LD1	TA1	R23	R21				
	LD4	LD5	LD2	TA2	R24	R22				
	LD5	LD4	LD3	TA3	R25	R23				
	LD6	LD3	LD4	TA4	R26	R24				
	LD7	LD2	LD5	TA5	R27	R25				
	CD2	CD7	CD0	TA6	G22	G20	DTB- DTB+	→ →		
	CD3	CD6	CD1	TB0	G23	G21				
	CD4	CD5	CD2	TB1	G24	G22				
	CD5	CD4	CD3	TB2	G25	G23				
	CD6	CD3	CD4	TB3	G26	G24				
	CD7	CD2	CD5	TB4	G27	G25				
	RD2	RD7	RD0	TB5	B22	B20	DTC- DTC+	→ →		
	RD3	RD6	RD1	TB6	B23	B21				
	RD4	RD5	RD2	TC0	B24	B22				
	RD5	RD4	RD3	TC1	B25	B23				
	RD6	RD3	RD4	TC2	B26	B24				
	RD7	RD2	RD5	TC3	B27	B25				
	Note3	RSVD	RSVD	RSVD	TC4	HSYNC	HSYNC	DTD- DTD+	→ →	
		RSVD	RSVD	RSVD	TC5	VSYNC	VSYNC			
		DE	DE	DE	TC6	DE	DE			
		LD0	LD1	LD6	TD0	R20	R26			
		LD1	LD0	LD7	TD1	R21	R27			
		CD0	CD1	CD6	TD2	G20	G26			
CD1		CD0	CD7	TD3	G21	G27	DTCLK- DTCLK+	→ → →		
RD0		RD1	RD6	TD4	B20	B26				
RD1		RD0	RD7	TD5	B21	B27				
N C		N C	N C	TD6	-	-				
CLK		CLK	CLK	CLK	CLK	CLK				

Note1: High must be Open.

Note2: Twist pair wires with 100Ω (Characteristic impedance) should be used between LCD panel signal processing board and LVDS transmitter. ☆

Note3: Input signal RSVD is not used inside the product, but do not keep this pin open to avoid noise problem. ☆

4.7 DISPLAY GRAY SCALE AND INPUT DATA SIGNALS

This product can display 256 gray scales in each LCR sub-pixel and 766 gray scales per 1 pixel. Also the relation between display gray scale and input data signals is as the following table.

Display gray scale		Data signal (0: Low level, 1: High level)																							
		LA7 LA6 LA5 LA4 LA3 LA2 LA1 LA0	CA7 CA6 CA5 CA4 CA3 CA2 CA1 CA0	RA7 RA6 RA5 RA4 RA3 RA2 RA1 RA0																					
		LB7 LB6 LB5 LB4 LB3 LB2 LB1 LB0	CB7 CB6 CB5 CB4 CB3 CB2 CB1 CB0	RB7 RB6 RB5 RB4 RB3 RB2 RB1 RB0																					
		LC7 LC6 LC5 LC4 LC3 LC2 LC1 LC0	CC7 CC6 CC5 CC4 CC3 CC2 CC1 CC0	RC7 RC6 RC5 RC4 RC3 RC2 RC1 RC0																					
		LD7 LD6 LD5 LD4 LD3 LD2 LD1 LD0	CD7 CD6 CD5 CD4 CD3 CD2 CD1 CD0	RD7 RD6 RD5 RD4 RD3 RD2 RD1 RD0																					
Left sub-pixel gray scale	Black	0 0 0 0 0 0 0 0	0 0 0 0 0 0 0 0	0 0 0 0 0 0 0 0																					
	dark	0 0 0 0 0 0 0 1	0 0 0 0 0 0 0 0	0 0 0 0 0 0 0 0																					
	↑	0 0 0 0 0 0 1 0	0 0 0 0 0 0 0 0	0 0 0 0 0 0 0 0																					
	↓	⋮	⋮	⋮																					
	bright	1 1 1 1 1 1 0 1	0 0 0 0 0 0 0 0	0 0 0 0 0 0 0 0																					
Center sub-pixel gray scale	Black	0 0 0 0 0 0 0 0	0 0 0 0 0 0 0 0	0 0 0 0 0 0 0 0																					
	dark	0 0 0 0 0 0 0 0	0 0 0 0 0 0 0 0	0 0 0 0 0 0 0 0																					
	↑	0 0 0 0 0 0 0 0	0 0 0 0 0 0 0 0	0 0 0 0 0 0 0 0																					
	↓	⋮	⋮	⋮																					
	bright	0 0 0 0 0 0 0 0	1 1 1 1 1 1 0 1	0 0 0 0 0 0 0 0																					
Right sub-pixel gray scale	Black	0 0 0 0 0 0 0 0	0 0 0 0 0 0 0 0	0 0 0 0 0 0 0 0																					
	dark	0 0 0 0 0 0 0 0	0 0 0 0 0 0 0 0	0 0 0 0 0 0 0 1																					
	↑	0 0 0 0 0 0 0 0	0 0 0 0 0 0 0 0	0 0 0 0 0 0 1 0																					
	↓	⋮	⋮	⋮																					
	bright	0 0 0 0 0 0 0 0	0 0 0 0 0 0 0 0	1 1 1 1 1 1 0 1																					
White	Black	0 0 0 0 0 0 0 0	0 0 0 0 0 0 0 0	0 0 0 0 0 0 0 0																					
	dark	0 0 0 0 0 0 0 0	0 0 0 0 0 0 0 0	0 0 0 0 0 0 0 0																					
	↑	0 0 0 0 0 0 0 0	0 0 0 0 0 0 0 0	0 0 0 0 0 0 0 0																					
	↓	⋮	⋮	⋮																					
	bright	0 0 0 0 0 0 0 0	0 0 0 0 0 0 0 0	1 1 1 1 1 1 1 1																					

4.8 INPUT SIGNAL TIMINGS

4.8.1 Timing characteristics

Parameter		Symbol	min.	typ.	max.	Unit	Remarks	
CLK	Frequency	1/ tc	60.0	65.0	66.0	MHz	15.38ns (typ.)	
	Duty	-	See the data sheet of LVDS transmitter.			-	-	
	Rise time, Fall time	-				ns	-	
DE	Horizontal	Cycle	th	10.34	10.34	10.77	$\mu$ s	96.72kHz (typ.) Note1
		Display period	thd	640	672	700	CLK	
	Vertical	Cycle	tv	15.47	16.667	17.9	ms	typ.=60.0Hz
		Display period	tvd	1,547	1,612	1,628	H	
	CLK-DE	Setup time	-	See the data sheet of LVDS transmitter.			ns	-
		Hold time	-				ns	-
	Rise time, Fall time		-				ns	-
DATA (A) to (D)	CLK-DATA	Setup time	-	See the data sheet of LVDS transmitter.			ns	-
		Hold time	-				ns	-
	Rise time, Fall time		-				ns	-

Note1: The sum of jitter and skew of horizontal period should be within  $\pm 1$  CLK.

4.8.2 Input signal timing chart

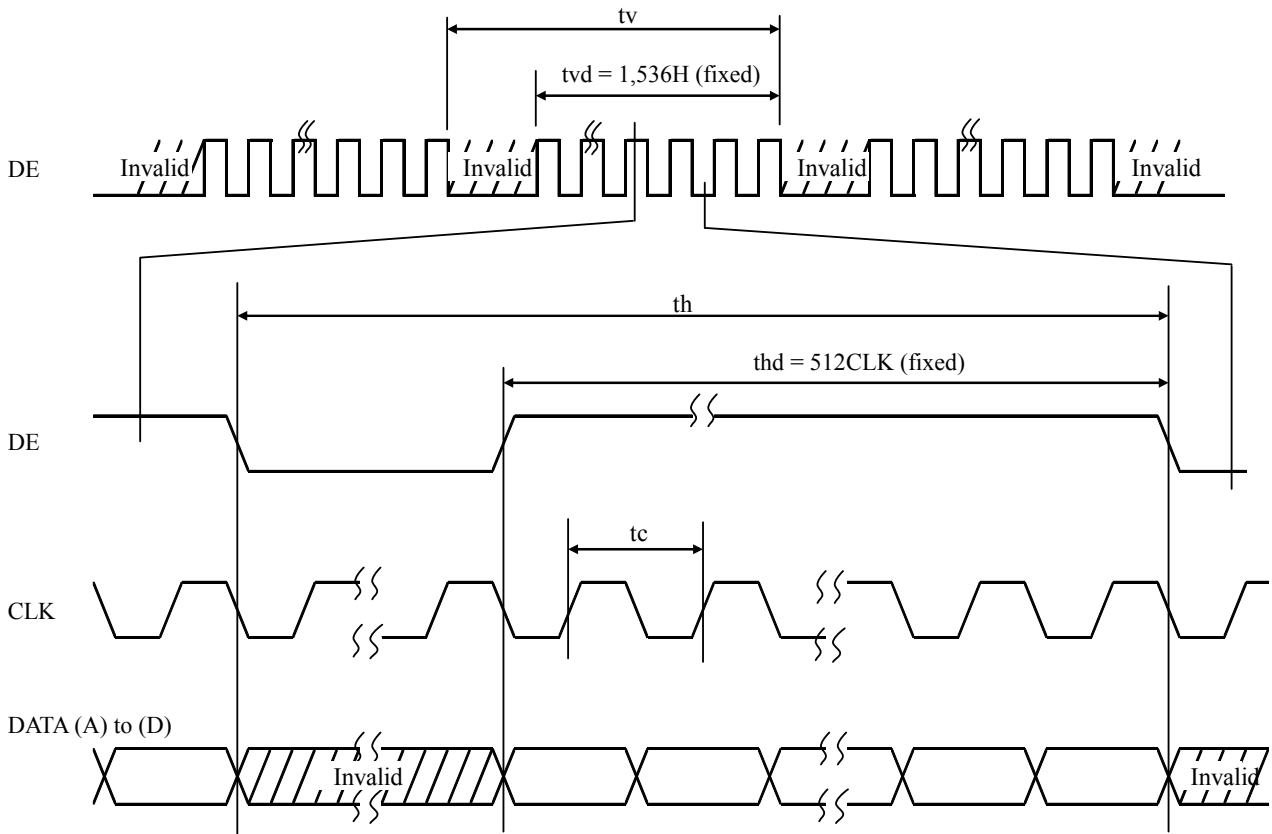

4.9 LVDS DATA TRANSMISSION METHOD

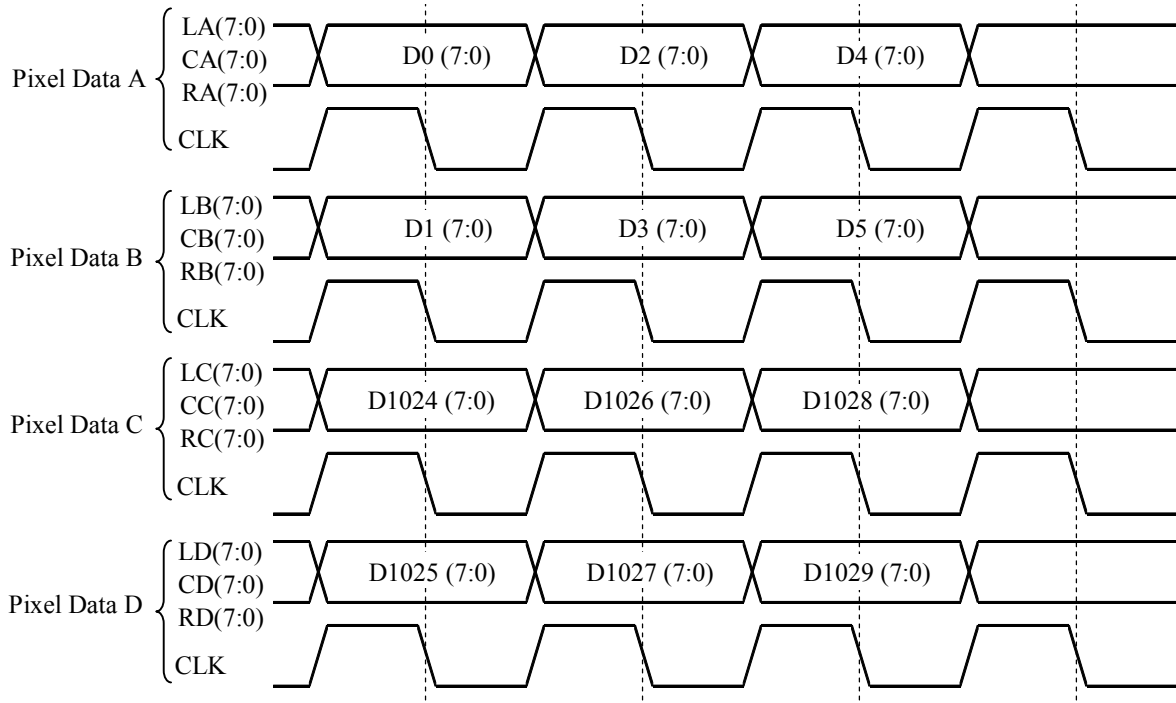

4.10 DISPLAY POSITIONS

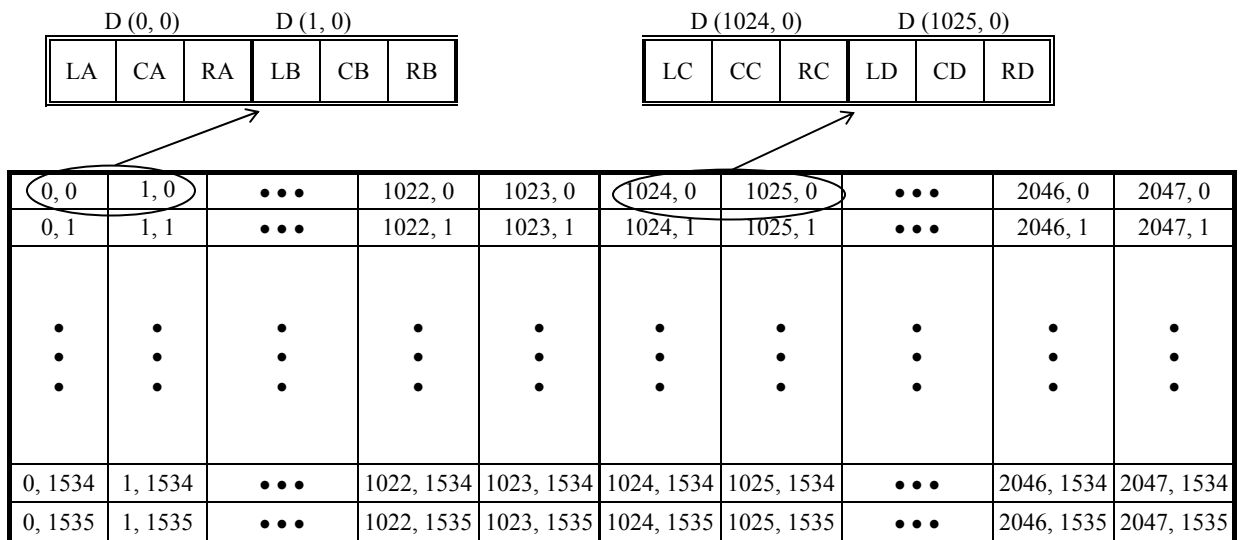

4.11 PIXEL ARRANGMENT

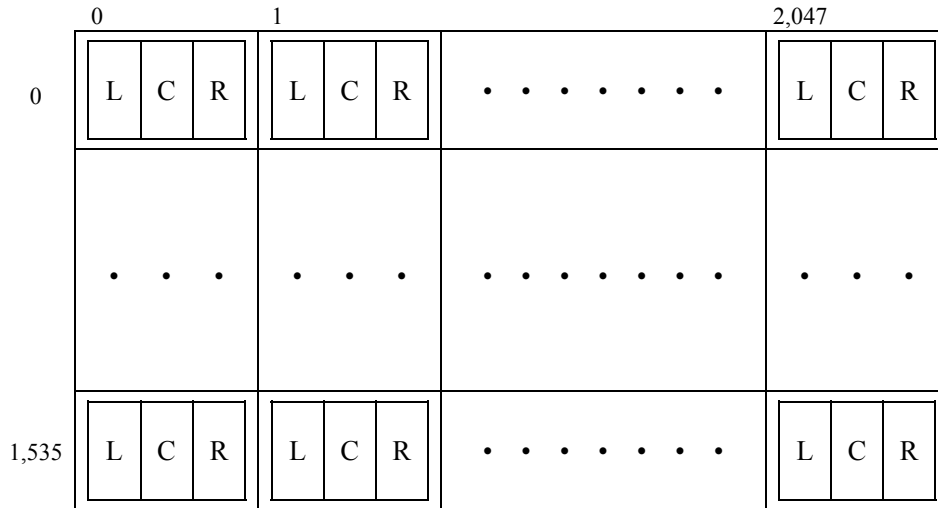

4.12 TEN-bit LOOK UP TABLE FOR GAMMA ADJUSTMENT

Adjustment of gamma characteristics for each 8-bit LCR data is possible by using built-in 10-bit LUT (look up table) for Gamma characteristics.

The LUT is set with the serial data. The combination of the control command determines Random/Sequential Address WRITE and Individual/Simultaneous LCR setting.

The serial data is composed as Table1.

Table1: Serial data Composition

DATA	DATA name	Function	Remarks
D31	CMD5	Control Command	See Table2 and 3.
D30	CMD4	Control Command	
D29	CMD3	Control Command	
D28	CMD2	Control Command	
D27	CMD1	Control Command	
D26	CMD0	Control Command	
D25	ADD9	LUT Address (MSB)	See Table4.
D24	ADD8	LUT Address	
D23	ADD7	LUT Address	
D22	ADD6	LUT Address	
D21	ADD5	LUT Address	
D20	ADD4	LUT Address	
D19	ADD3	LUT Address	
D18	ADD2	LUT Address	
D17	ADD1	LUT Address	
D16	ADD0	LUT Address (LSB)	
D15	DATA15	LUT Data (MSB)	See Table5.
D14	DATA14	LUT Data	
D13	DATA13	LUT Data	
D12	DATA12	LUT Data	
D11	DATA11	LUT Data	
D10	DATA10	LUT Data	
D9	DATA9	LUT Data	
D8	DATA8	LUT Data	
D7	DATA7	LUT Data	
D6	DATA6	LUT Data	
D5	DATA5	LUT Data	
D4	DATA4	LUT Data	
D3	DATA3	LUT Data	
D2	DATA2	LUT Data	
D1	DATA1	LUT Data	
D0	DATA0	LUT Data (LSB)	

Table2: Command table (CMD5 to CMD0: 6-bit)

DATA name	Parameter	Remarks
CMD5	Must be set to "1".	-
CMD4	Must be set to "1".	-
CMD3	Selection of Random/Sequential Address WRITE "1": Random Address WRITE "0": Sequential Address WRITE	-
CMD2	Must be set to "1".	-
CMD1	Selection of Individual/Simultaneous LCR setting "1": Individual LCR setting "0": Simultaneous LCR setting	"1": Select the Sub-pixel by using ADD9 and ADD8. (See Table4.) "0": ADD9 and ADD8 are invalid.
CMD0	Must be set to "0".	-

Table3: Command table (CMD5 to CMD0: 6-bit)

CMD5	CMD4	CMD3	CMD2	CMD1	CMD0	Function
1	1	1	1	1	0	Random Address WRITE, Individual LCR setting
1	1	1	1	0	0	Random Address WRITE, Simultaneous LCR setting
1	1	0	1	1	0	Sequential Address WRITE, Individual LCR setting
1	1	0	1	0	0	Sequential Address WRITE, Simultaneous LCR setting

\*Other combinations are prohibited, and may cause function error.

Table4: Address table (ADD9 to ADD0: 10-bit)

DATA name	Parameter	Remarks	
ADD9	Sub-pixel Selection ADD[9:8]= 0:0 Left Sub-pixel	When "ADD[9:8]=1:1", ON/OFF of Gamma correction can select according to the GMA[2:0]. (See Table6 and Table7.)	
ADD8	0:1 Center Sub-pixel 1:0 Right Sub-pixel 1:1 ON/OFF selection of Gamma Correction		
ADD7	LUT Address 256 address = 00h - FFh		When "ADD[9:8] = 1:1", ADD[7:0] must be set to 00h.
ADD6			
ADD5			
ADD4			
ADD3			
ADD2			
ADD1			
ADD0			



Table5: Data table (DATA15 to DATA0: 16bit)

DATA	DATA name	Parameter	Remarks
DATA15	Dummy	Dummy Data Must be set to "0".	-
DATA14	Dummy		
DATA13	Dummy		
DATA12	Dummy		
DATA11	Dummy		
DATA10	Dummy		
DATA9	DATA9	[MSB]	-
DATA8	DATA8	10-bit LUT Data 000h - 3FFh	
DATA7	DATA7		
DATA6	DATA6		
DATA5	DATA5		
DATA4	DATA4		
DATA3	DATA3		
DATA2	DATA2		
DATA1	DATA1		
DATA0	DATA0	[LSB]	

Table6: Gamma correction table (DATA15 to DATA0: 16bit)

DATA	DATA name	Parameter	Remarks
DATA15	Dummy	Dummy Data Must be set to "0".	-
DATA14	Dummy		
DATA13	Dummy		
DATA12	Dummy		
DATA11	Dummy		
DATA10	Dummy		
DATA9	Dummy		
DATA8	Dummy		
DATA7	Dummy		
DATA6	Dummy		
DATA5	Dummy		
DATA4	Dummy		
DATA3	Dummy		
DATA2	GAM2	[MSB]	See Table7.
DATA1	GAM1	GMA Data	
DATA0	GAM0	[LSB]	

Table7: Control code GAM[2:0]

GMA2	GMA1	GMA0	Function
0	0	0	No correction (Initial setting)
0	0	1	Correction according to the LUT Data. Note1

\*Other combinations are prohibited, and may cause function error.

Note1: Initial setting of the LUT is undefined data. The LUT should be enabled by setting of the GMA after writing the LUT data in all the 256 addresses, in order to avoid undefined data display.

Note2: Transfer the data every power-on, because the LUT data isn't stored in the LCD module.

Note3: As writing and reading the LUT data, a noise may appear on the display image. In order to prevent the noise appearing on the display, following measures should be performed.

(1)The LUT data should be rewritten during invalid period of pixel data (See "4.8 INPUT SIGNAL TIMINGS").

(2) The LUT data should be rewritten when the Gamma Correction is OFF (GMA[2:0] = 000).

☆

4.13 LUT SERIAL COMMUNICATION TIMINGS

(1) Timing chart

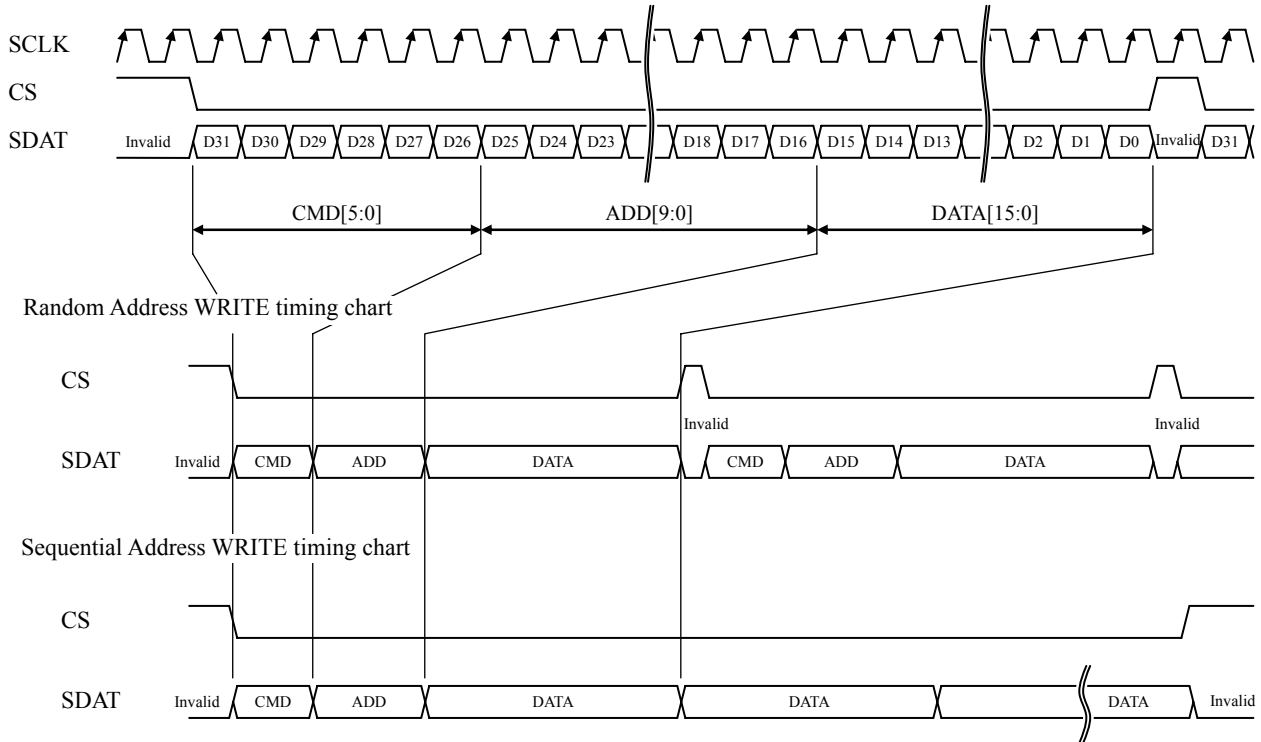

(2) Timing specifications

Parameter	Symbol	min.	typ.	max.	Unit	Remarks
SCLK Frequency	1/Tsck	-	-	5	MHz	-
SCLK Pulse	Twsck	50	-	-	ns	-
SDAT-SCLK Setup Time	Tds	50	-	-	ns	-
SDAT-SCLK Hold Time	Tdh	50	-	-	ns	-
CS-SCLK Setup Time	Tcs	50	-	-	ns	-
CS-SCLK Hold Time	Tch	50	-	-	ns	-

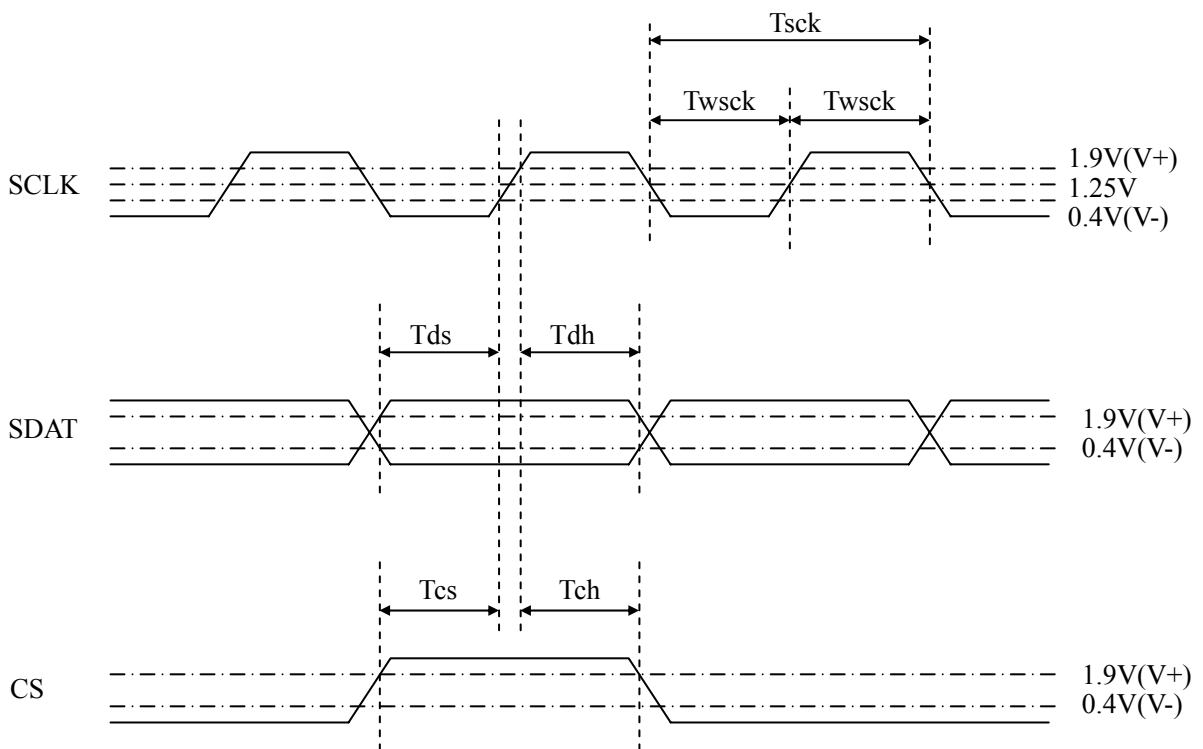

Note1: During the serial communication mode, the display noise may appear because of rewriting the data. To avoid this, rewrite the LUT data when the pixel data is invalid or the Gamma Correction is OFF (GMA[2:0] = 000). The external noise may cause the data change, refresh the data regularly according to need.

4.14 OPTICS

4.14.1 Optical characteristics

(1)NL204153BM21-01

(Note1, Note2)

Parameter	Condition	Symbol	min.	typ.	max.	Unit	Measuring instrument	Remarks
Luminance	White at center $\theta R = 0^\circ, \theta L = 0^\circ, \theta U = 0^\circ, \theta D = 0^\circ$	L	700	800	-	cd/m <sup>2</sup>	BM-5A or SR-3	-
Contrast ratio	White/Black at center $\theta R = 0^\circ, \theta L = 0^\circ, \theta U = 0^\circ, \theta D = 0^\circ$	CR	450	700	-	-	BM-5A or SR-3	Note3
Luminance uniformity	White $\theta R = 0^\circ, \theta L = 0^\circ, \theta U = 0^\circ, \theta D = 0^\circ$	LU	-	1.2	1.3	-	BM-5A	Note4
Chromaticity	White	x coordinate	-	0.255	-	-	SR-3	Note5
		y coordinate	-	0.310	-	-		
Response time		Black to White	-	17	25	ms	BM-5A	Note6 Note7
		White to Black	-	18	25	ms		
Viewing angle	Right	$\theta U = 0^\circ, \theta D = 0^\circ, CR \geq 10$	$\theta R$	70	85	-	BM-5A	Note8
	Left	$\theta U = 0^\circ, \theta D = 0^\circ, CR \geq 10$	$\theta L$	70	85	-		
	Up	$\theta R = 0^\circ, \theta L = 0^\circ, CR \geq 10$	$\theta U$	70	85	-		
	Down	$\theta R = 0^\circ, \theta L = 0^\circ, CR \geq 10$	$\theta D$	70	85	-		

(2)NL204153BM21-01A

(Note1, Note2)

Parameter	Condition	Symbol	min.	typ.	max.	Unit	Measuring instrument	Remarks
Luminance	White at center $\theta R = 0^\circ, \theta L = 0^\circ, \theta U = 0^\circ, \theta D = 0^\circ$	L	650	800	-	cd/m <sup>2</sup>	BM-5A or SR-3	-
Contrast ratio	White/Black at center $\theta R = 0^\circ, \theta L = 0^\circ, \theta U = 0^\circ, \theta D = 0^\circ$	CR	450	700	-	-	BM-5A or SR-3	Note3
Luminance uniformity	White $\theta R = 0^\circ, \theta L = 0^\circ, \theta U = 0^\circ, \theta D = 0^\circ$	LU	-	1.2	1.3	-	BM-5A	Note4
Chromaticity	White	x coordinate	-	0.280	-	-	SR-3	Note5
		y coordinate	-	0.304	-	-		
Response time		Black to White	-	17	25	ms	BM-5A	Note6 Note7
		White to Black	-	18	25	ms		
Viewing angle	Right	$\theta U = 0^\circ, \theta D = 0^\circ, CR \geq 10$	$\theta R$	70	85	-	BM-5A	Note8
	Left	$\theta U = 0^\circ, \theta D = 0^\circ, CR \geq 10$	$\theta L$	70	85	-		
	Up	$\theta R = 0^\circ, \theta L = 0^\circ, CR \geq 10$	$\theta U$	70	85	-		
	Down	$\theta R = 0^\circ, \theta L = 0^\circ, CR \geq 10$	$\theta D$	70	85	-		

Note1: These are initial characteristics.

Note2: Measurement conditions are as follows.

Ta = 25°C, VDD = 12.0V, IBL = 6.0mA/lamp, Display mode: QXGA,  
Horizontal cycle = 1/96.72kHz, Vertical cycle = 1/60.0Hz

Optical characteristics are measured after 20 minutes from working the product, in the dark room. Also measurement methods are as follows.

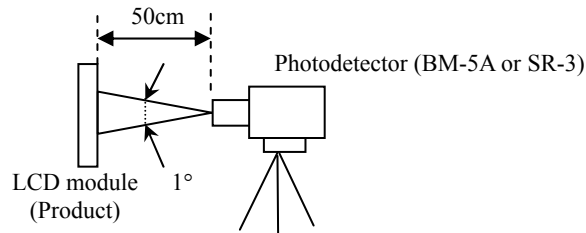

Note3: See "**4.14.2 Definition of contrast ratio**".

Note4: See "**4.14.3 Definition of luminance uniformity**".

Note5: These coordinates are found on CIE 1931 chromaticity diagram.

Note6: Product surface temperature: TopF = 35 °C

Note7: See "**4.14.4 Definition of response times**".

Note8: See "**4.14.5 Definition of viewing angles**".

4.14.2 Definition of contrast ratio

The contrast ratio is calculated by using the following formula.

$$\text{Contrast ratio (CR)} = \frac{\text{Luminance of white screen}}{\text{Luminance of black screen}}$$

4.14.3 Definition of luminance uniformity

The luminance uniformity is calculated by using following formula.

$$\text{Luminance uniformity (LU)} = \frac{\text{Maximum luminance from ① to ⑤}}{\text{Minimum luminance from ① to ⑤}}$$

The luminance is measured at near the 5 points shown below.

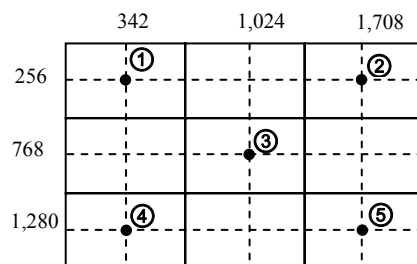

4.14.4 Definition of response times

Response time is measured, the luminance changes from "black" to "white", or "white" to "black" on the same screen point, by photo-detector. Ton is the time it takes the luminance change from 10% up to 90%. Also Toff is the time it takes the luminance change from 90% down to 10% (See the following diagram.).

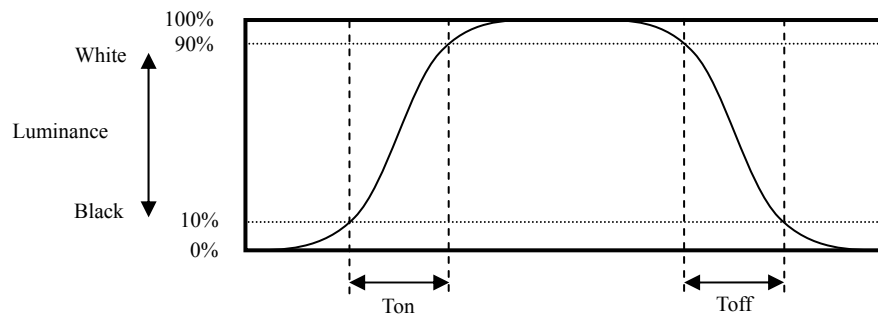

4.14.5 Definition of viewing angles

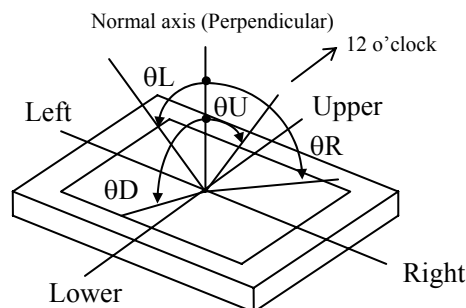

5. RELIABILITY TESTS

Test item	Condition	Judgment Note1
High temperature and humidity (Operation)	① 60 ± 2°C, RH = 60%, 240hours ② Display data is white.	No display malfunctions
Heat cycle (Operation)	① 0 ± 3°C...1hour 55 ± 3°C...1hour ② 50cycles, 4hours/cycle ③ Display data is white.	
Thermal shock (Non operation)	① -20 ± 3°C...30minutes 60 ± 3°C...30minutes ② 100cycles, 1hour/cycle ③ Temperature transition time is within 5 minutes.	
Vibration (Non operation)	① 5 to 100Hz, 11.76m/s <sup>2</sup> ② 1 minute/cycle ③ X, Y, Z direction ④ 10 times each directions	No display malfunctions No physical damages
Mechanical shock (Non operation)	① 294m/s <sup>2</sup> , 11ms ② X, Y, Z direction ③ 3 times each directions	
ESD (Operation)	① 150pF, 150Ω, ±10kV ② 9 places on a panel surface Note2 ③ 10 times each places at 1 sec interval	No display malfunctions
Dust (Operation)	① Sample dust: No.15 (by JIS-Z8901) ② 15 seconds stir ③ 8 times repeat at 1 hour interval	
Low pressure	Non-operation ① 15 kPa (Equivalent to altitude 13,600m) ② -20°C±3°C...24 hours ③ +60°C±3°C...24 hours	No display malfunctions
	Operation ① 53.3 kPa (Equivalent to altitude 4,850m) ② 0°C±3°C...24 hours ③ +55°C±3°C...24 hours	

Note1: Display and appearance are checked under environmental conditions equivalent to the inspection conditions of defect criteria.

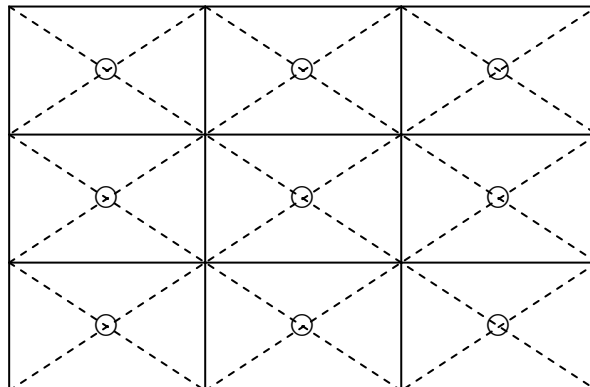

Note2: See the following figure for discharge points



6. PRECAUTIONS

6.1 MEANING OF CAUTION SIGNS

The following caution signs have very important meaning. **Be sure to read "6.2 CAUTIONS" and "6.3 ATTENTIONS", after understanding these contents!**

	This sign has the meaning that customer will be injured by himself or the product will sustain a damage, if customer has wrong operations.
	This sign has the meaning that customer will get an electrical shock, if customer has wrong operations.
	This sign has the meaning that customer will be injured by himself, if customer has wrong operations.

6.2 CAUTIONS



**\* Do not touch the working backlight. There is a danger of an electric shock.**



**\* Do not touch the working backlight. There is a danger of burn injury.**  
**\* Do not shock and press the LCD panel and the backlight! There is a danger of breaking, because they are made of glass. (Shock: To be not greater 294m/s<sup>2</sup> and to be not greater 11ms, Pressure: To be not greater 19.6N (φ16mm jig))**

☆

6.3 ATTENTIONS 

6.3.1 Handling of the product

- ① Take hold of both ends without touching the circuit board when the product (LCD module) is picked up from inner packing box to avoid broken down or misadjustment, because of stress to mounting parts on the circuit board.
- ② Do not hook nor pull cables such as lamp cable, and so on, in order to avoid any damage.
- ③ When the product is put on the table temporarily, display surface must be placed downward.
- ④ When handling the product, take the measures of electrostatic discharge with such as earth band, ionic shower and so on, because the product may be damaged by electrostatic.
- ⑤ The torque for product mounting screws must never exceed 0.735 N·m. Higher torque might result in distortion of the bezel. And the length of product mounting screws must be ≤ 5.3mm.
- ⑥ The product must be installed using mounting holes without undue stress such as bends or twist (See outline drawings). And do not add undue stress to any portion (such as bezel flat area). Bends or twist described above and undue stress to any portion may cause display mura.
- ⑦ Do not press or rub on the sensitive product surface. When cleaning the product surface, use of the cloth with ethanolic liquid such as screen cleaner for LCD is recommended.



- ⑧ Do not push nor pull the interface connectors while the product is working.
- ⑨ Do not bend or unbend the lamp cable at the near part of the lamp holding rubber, to avoid the damage for high voltage side of the lamp.
- ⑩ When handling the product, use of an original protection sheet on the product surface (polarizer) is recommended for protection of product surface. Adhesive type protection sheet may change color or characteristics of the polarizer.

### 6.3.2 Environment

- ① Do not operate or store in high temperature, high humidity, dewdrop atmosphere or corrosive gases. Keep the product in packing box with antistatic pouch in room temperature to avoid dusts and sunlight, when storing the product.
- ② In order to prevent dew condensation occurring by temperature difference, the product packing box should be opened after enough time being left under the environment of an unpacking room. Evaluate the leaving time sufficiently because a situation of dew condensation occurring is changed by the environmental temperature and humidity. (Recommended leaving time: 6 hours or more with packing state)
- ③ Do not operate in high magnetic field. Circuit boards may be broken down by it.
- ④ This product is not designed as radiation hardened.

### 6.3.3 Characteristics

**The following items are neither defects nor failures.**

- ① Response time, luminance and color may be changed by ambient temperature.
- ② Display mura, flicker, vertical seam or small spot may be observed depending on display patterns.
- ③ Optical characteristics (e.g. luminance, display uniformity, etc.) gradually is going to change depending on operating time, and especially low temperature, because the LCD has cold cathode fluorescent lamps.
- ④ Do not display the fixed pattern for a long time because it may cause image sticking. Use a screen saver, if the fixed pattern is displayed on the screen.
- ⑤ The display color may be changed depending on viewing angle because of the use of condenser sheet in the backlight.
- ⑥ Optical characteristics may be changed depending on input signal timings.
- ⑦ The interference noise between input signal frequency for this product's signal processing board and luminance control frequency of the inverter may appear on a display. Set up luminance control frequency of the inverter so that the interference noise does not appear.

### 6.3.4 Other

- ① All VDD and GND terminals should be used without any non-connected lines.
- ② Do not disassemble a product or adjust variable resistors.
- ③ See "REPLACEMENT MANUAL FOR BACKLIGHT UNIT", when replacing backlight lamps. ☆
- ④ Pack the product with original shipping package, in order to avoid any damages during transportation, when returning the product to NEC for repair and so on.
- ⑤ The LCD module by itself or integrated into end product should be packed and transported with display in the vertical position. Otherwise the display characteristics may be degraded.

7. OUTLINE DRAWINGS  
7.1 FRONT VIEW

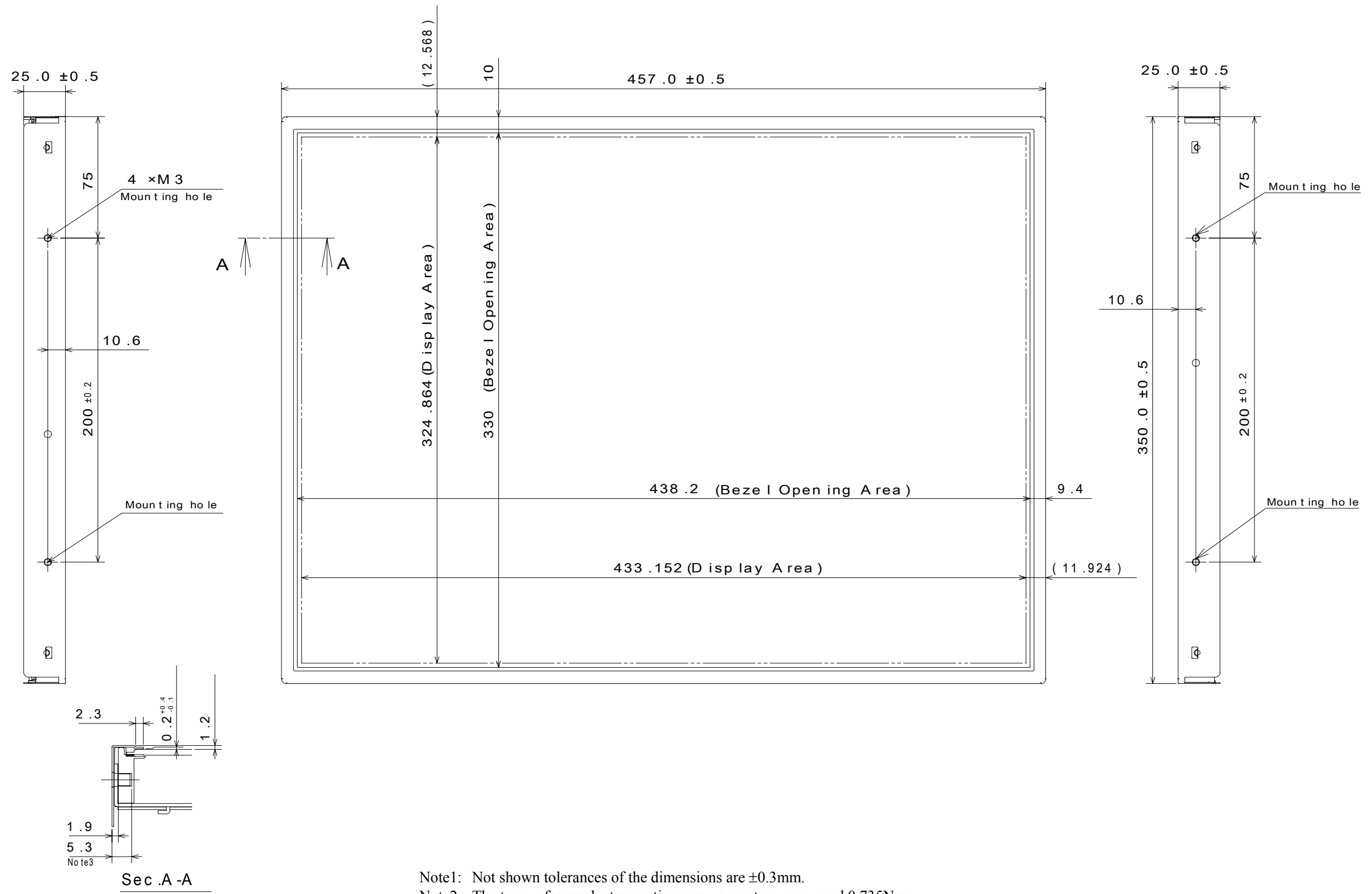

- Note1: Not shown tolerances of the dimensions are  $\pm 0.3$ mm.  
 Note2: The torque for product mounting screws must never exceed  $0.735$ N·m.  
 Note3: The length of product mounting screws from surface of plate must be  $\leq 5.3$ mm.  
 Note4: The values in parentheses are for reference.

Unit: mm

7.2 REAR VIEW

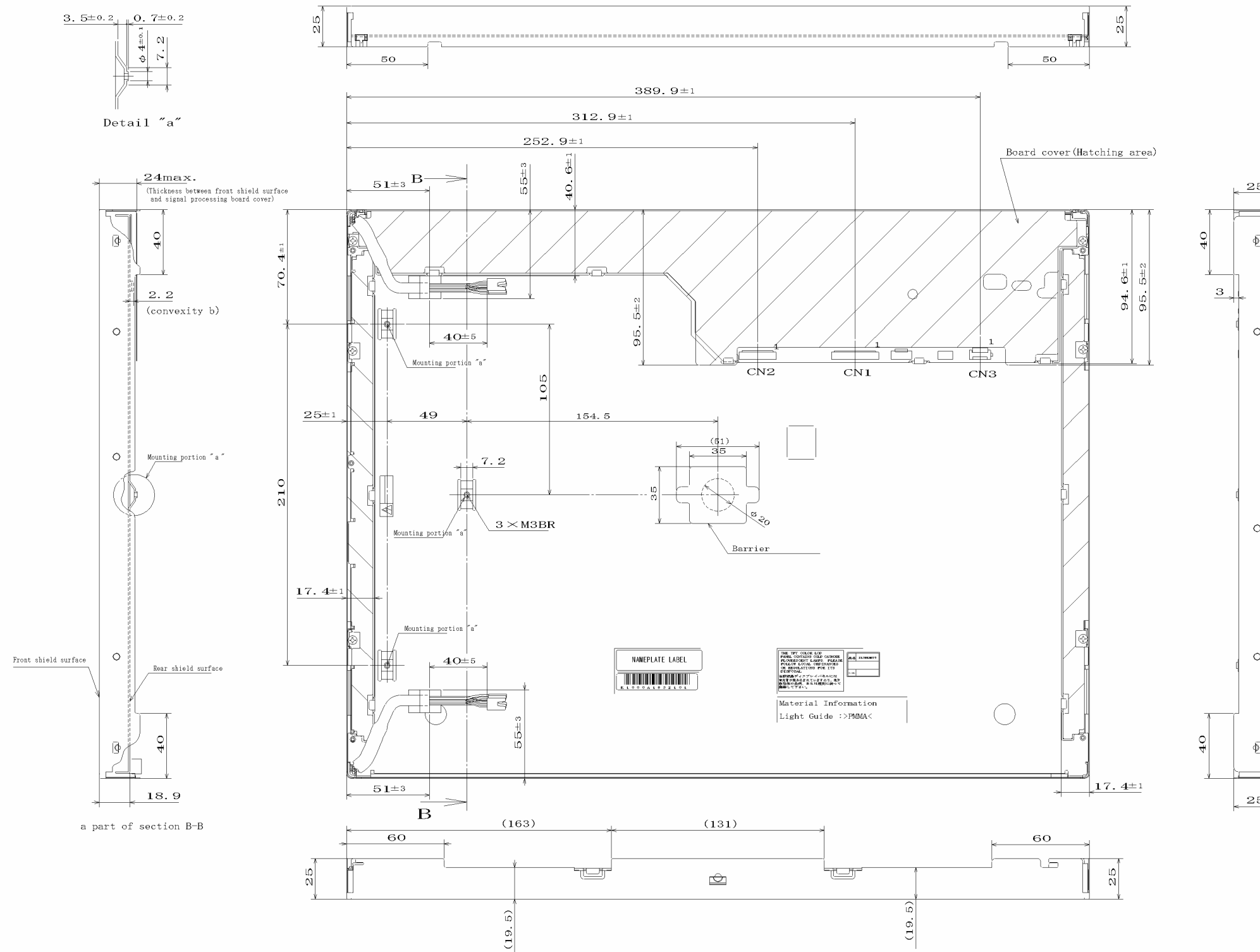

- Note1: Not shown tolerances of the dimensions are ±0.3mm.
- Note2: The torque for product mounting screws must never exceed 0.735N·m.
- Note3: The values in parentheses are for reference.

Unit: mm