

Features

- Maximum Output Current: 300mA
- Dropout Voltage: 180mV @ $I_{OUT}=300mA$ and $V_O=3.3V$
- Operating Voltage Range: 2.7V to 5.5V
- Standby Current: Less than 0.1uA (TYP.)
- High Ripple Rejection: 80dB (1kHz)
- Fast Start-Up
- Quick Discharge
- Operating Temperature Range: $-40^{\circ}C \sim +85^{\circ}C$
- Low ESR Capacitor Compatible: Ceramic Capacitor
- Ultra Small Packages: SOT23-5, SOT23-3 and WDFN-6L 1.6X1.6 package
- Pb-Free Package

Applications

- Mobile Phones, Cordless Phones
- Wireless Communication Equipment
- Portable Games
- Cameras, Video Recorders
- Portable AV Equipment
- Reference Voltage
- Battery Powered Equipment

General Description

The PAM3106 series are precise, low noise, positive voltage LDO regulators manufactured using CMOS processes. The series achieves high ripple rejection and low dropout and consists of a voltage reference, an error amplifier, a current limiter and a phase compensation circuit plus a driver transistor.

The series is also compatible with low ESR ceramic capacitors which give added output stability. This stability can be maintained even during load fluctuations due to the excellent transient response of the series.

The current limiter's foldback circuit also operates as a short protect for the output current limiter and the output pin.

The EN function enables the output to be turned off, resulting in greatly reduced power consumption.

Typical Application

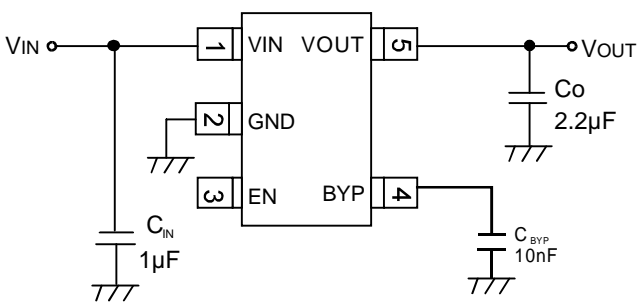

Block Diagram

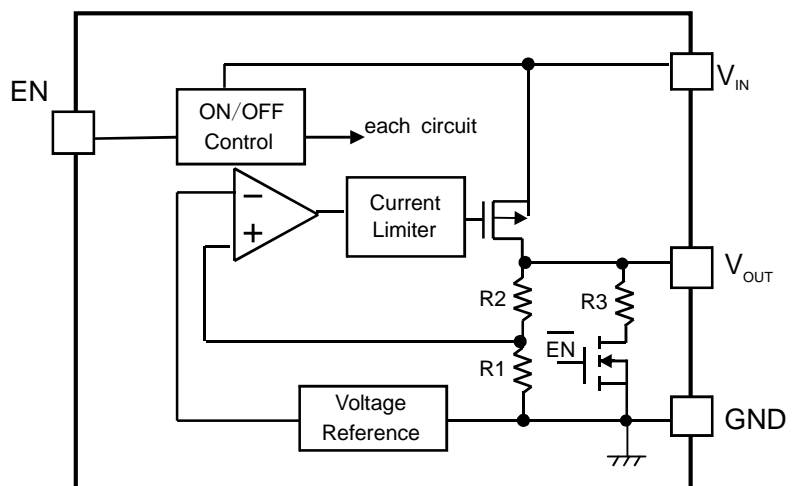

Pin Configuration & Marking Information

Top View
SOT23-5

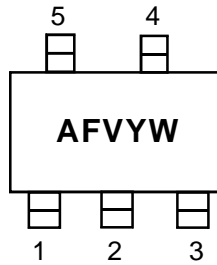

Top View
SOT23-3

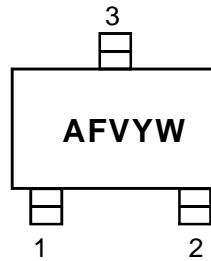

Top View
WDFN-6L 1.6X1.6

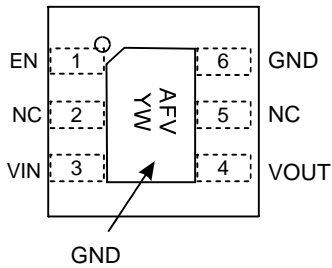

AF: Product Code
V: Voltage Code
Y: Year
W: Weekly

Pin Configuration Available

Pin	1	2	3	4	5	6
SOT23-3	GND	VOUT	VIN			
SOT23-5	VIN	GND	EN	BYP	VOUT	
	VIN	GND	EN	NC	VOUT	
WDFN-6L	EN	NC	VIN	VOUT	NC	GND

Pin Descriptions

Name	Function
VIN	Input
GND	Ground
VOUT	Output
EN	Chip Enable(active high)
NC	No Connected
BYP	Bypass



Absolute Maximum Ratings

These are stress ratings only and functional operation is not implied. Exposure to absolute maximum ratings for prolonged time periods may affect device reliability. All voltages are with respect to ground.

Input Voltage.....	5.5V	Storage Temperature.....	-65°C to 150°C
Output Current.....	300mA	ESD Rating.....	Class B
Output Pin Voltage	GND -0. 3V to VIN+0. 3V	HBM.....	2kV
Lead Soldering Temperature (5sec).....	300°C	MM.....	200V

Recommended Operating Conditions

Junction Temperature.....	-40°C to 125°C	Ambient Temperature.....	-40°C to 85°C
---------------------------	----------------	--------------------------	---------------

Thermal Information

Parameter	Symbol	Package	Maximum	Unit
Thermal Resistance (Junction to Case)	θ_{JC}	SOT-23	130	°C/W
		DFN1.6X1.6	160	
Thermal Resistance (Junction to Ambient)	θ_{JA}	SOT-23	250	°C/W
		DFN1.6X1.6	175	
Internal Power Dissipation	P_D	SOT-23	400	mW
		DFN1.6X1.6	570	



Electrical Characteristic

$V_{IN}=V_o+1V$, $T_A=25^{\circ}C$, $C_{IN}=1\mu F$, $C_o=2.2\mu F$, $C_{byp}=10nF$, unless otherwise noted

Parameter	Symbol	Conditions	MIN	TYP	MAX	UNITS
Output Voltage Accuracy	V_{OUT}	$I_{OUT}=150mA$	-2		2	%
Maximum Output Current	I_{OUTMAX}		300			mA
Load Regulation	LDR	$1mA \leq I_{OUT} \leq 300mA$		0.5		%
Quiescent Current	I_Q	$I_o=0mA$		90		μA
Standby Current	I_{stdby}	$V_{CE}=V_{SS}$		0.1	1	μA
Line Regulation	LNR	$V_{OUT}+1.0V \leq V_{IN} \leq 5.5V$ $I_{OUT}=30mA$		0.01	0.20	%/V
Input Voltage	V_{IN}		2.7		5.5	V
Temperature Characteristics	T_c	$I_{OUT}=30mA$ $-40^{\circ}C \leq T_{opr} \leq 85^{\circ}C$		40		ppm/ $^{\circ}C$
Power Supply Rejection Rate	PSRR	$I_{OUT}=50mA, f=1kHz, C_{by}=0nF$		60		dB
		$I_{OUT}=50mA, f=1kHz, C_{by}=10nF$ $C_{in}=C_o=2.2\mu F$		80		
Current Limiter	I_{lim}			400		mA
Short-circuit Current	I_{short}			120		mA
Fast start Time	t_f	$C_{byp}=0nF$		50		μs
Over Temperature Shutdown	OTS	no load		150		$^{\circ}C$
Over Temperature Hysteresis	OTH	no load		30		$^{\circ}C$
EN "High" Voltage	V_{ENH}		1.6		V_{IN}	V
EN "Low" Voltage	V_{ENL}				0.3	V
Enable Pin Current	I_{EN}			1	3	μA



Typical Performance Characteristics

$V_{IN} = V_o + 1V$, $T_A = 25^\circ C$, $C_{IN} = 1\mu F$, $C_o = 2.2\mu F$, $C_{byp} = 10nF$, $V_o = 1.2V$, unless otherwise noted

1. Output Voltage vs Output Current

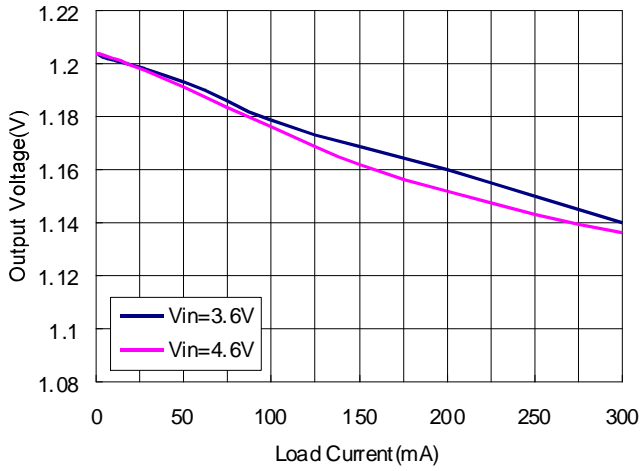

2. Dropout Voltage vs Output Current

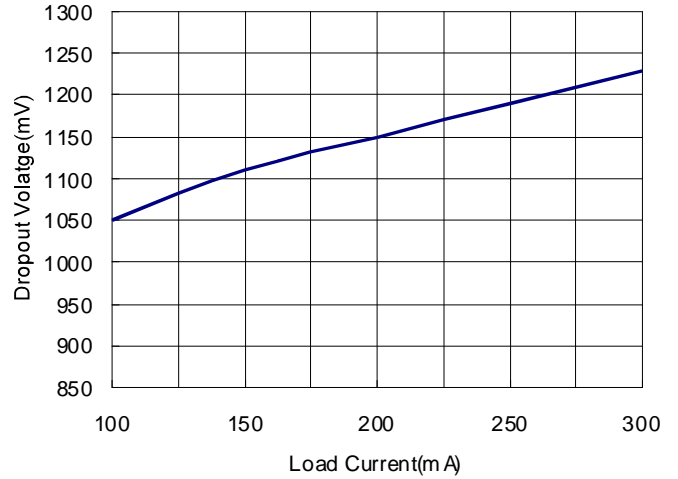

3. Quiescent Current vs Input Voltage

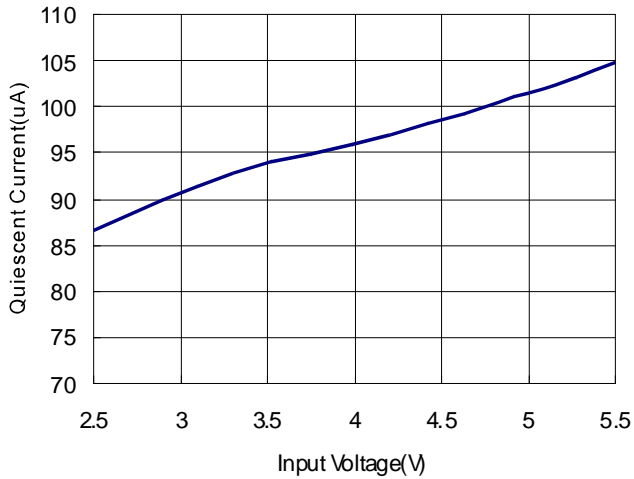

4. Temperature vs Output Voltage

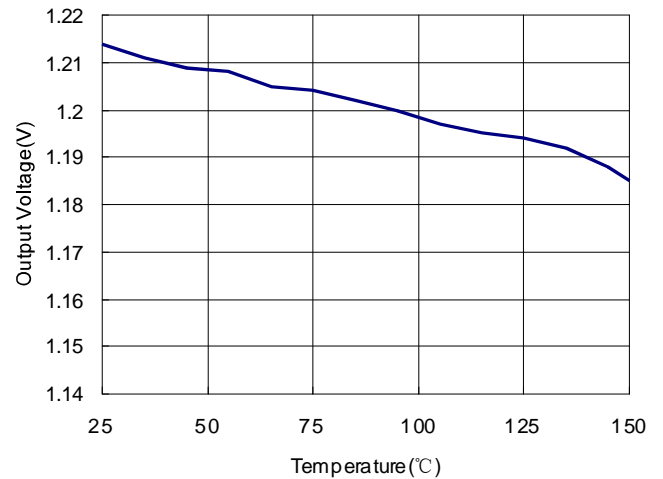

5. Ground Current vs Output Current

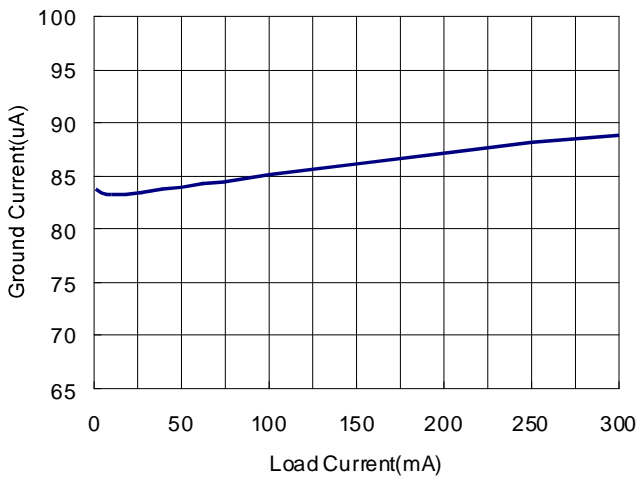

Typical Performance Characteristics

$V_{IN}=V_O+1V$, $T_A=25^\circ C$, $C_{IN}=1\mu F$, $C_O=2.2\mu F$, $C_{byp}=10nF$, $V_O=1.2V$, unless otherwise noted

6. Load Regulation Transient

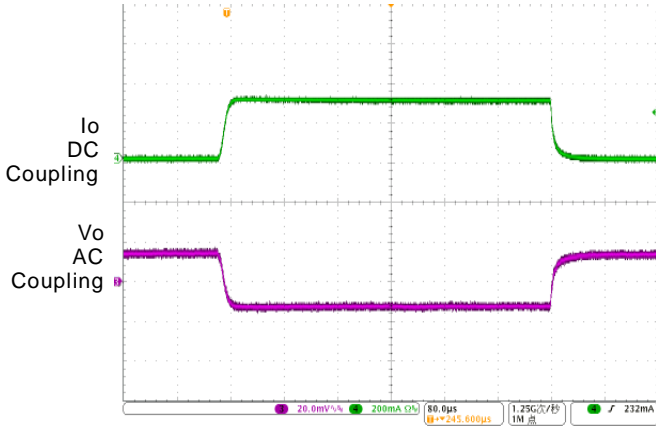

$I_O=0mA$ to 300mA

7. Line Regulation Transient



$V_{IN}=2.7V$ to 5V, $I_O=100mA$

8. EN Start Up Response ($C_{byp}=10nF$)

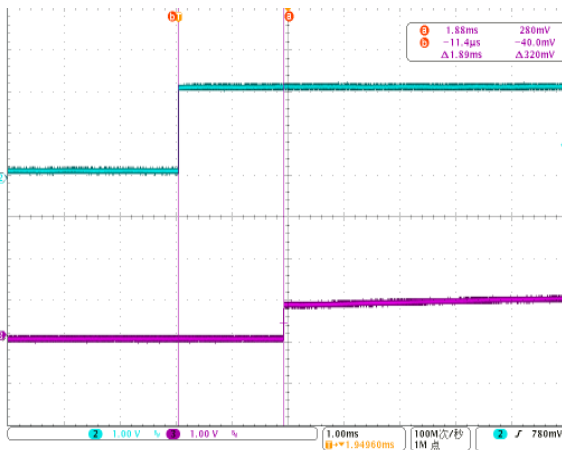

$V_{IN}=5V$, $V_{EN}=0$ to 2V, $I_O=100mA$

9. PSRR

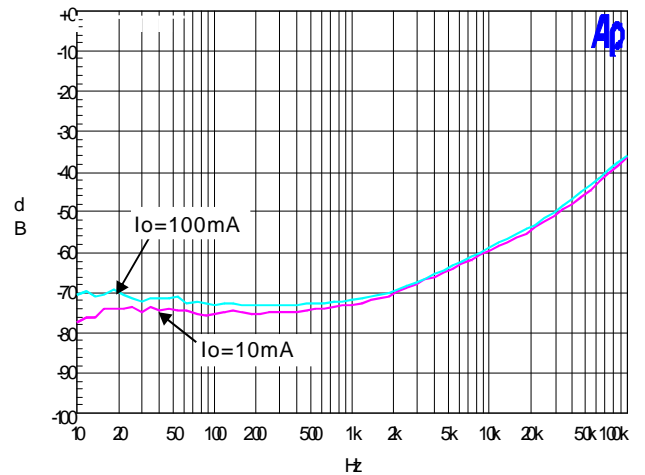

$V_{IN}=3.6V$, $V_{pp}=500mV$, $C_{byp}=10nF$



Application Information

Capacitor Selection and Regulator Stability

Similar to any low dropout regulator, the external capacitors used with the PAM3106 must be carefully selected for regulator stability and performance.

A capacitor C_{IN} of more than $1\mu F$ can be employed in the input pin, while there is no upper limit for the capacitance of C_{IN} . Please note that the distance between C_{IN} and the input pin of the PAM3106 should not exceed 0.5 inch. Ceramic capacitors are suitable for the PAM3106. Capacitors with larger values and lower ESR (equivalent series resistance) provide better PSRR and line-transient response.

The PAM3106 is designed specifically to work with low ESR ceramic output capacitors in order to save space and improve performance. Using an output ceramic capacitor whose value is $>2.2\mu F$ with $ESR > 5m\Omega$ ensures stability.

A 10nF bypass capacitor connected to BYP pin is suggested for suppressing output noise. The capacitor, in series connection with an internal 200k Ω resistor, forms a low-pass filter for noise reduction. Increasing the capacitance will slightly decrease the output noise, but increase the start-up time.

Load Transient Considerations

Curve 6 of the PAM3106 load-transient response on page 6 shows two components of the output response: a DC shift from the output impedance due to the load current change and transient response. The DC shift is quite small due to excellent load regulation of the PAM3106. The transient spike, resulting from a step change in the load current from 1mA to 300mA, is 20mV.

The ESR of the output capacitor is critical to the transient spike. A larger capacitance along with smaller ESR results in a smaller spike.

Shutdown Input Operation

The PAM3106 is shut down by pulling the EN input low, and is turned on by tying the EN input to VIN or leaving the EN input floating.

Internal P-Channel Pass Transistor

The PAM3106 features a 0.75 Ω P-Channel MOSFET device as a pass transistor. The P-MOS pass transistor enables the PAM3106 to consume only 90 μA of ground current during low dropout, light-load, or heavy-load operations. This feature increases the battery operation life time.

Input-Output (Dropout) Voltage

A regulator's minimum input-output voltage difference (or dropout voltage) determines the lowest usable supply voltage. The PAM3106 has a typical 300mV dropout voltage. In battery-powered systems, this will determine the useful end-of-life battery voltage.

Current Limit and Short Circuit Protection

The PAM3106 features a current limit, which monitors and controls the gate voltage of the pass transistor. The output current can be limited to 400mA by regulating the gate voltage. The PAM3106 also has a built-in short circuit current limit.



Thermal considerations

Thermal protection limits power dissipation in the PAM3106. When the junction temperature exceeds 150°C, the OTP (Over Temperature Protection) starts the thermal shutdown and turns the pass transistor off. The pass transistor resumes operation after the junction temperature drops below 120°C.

For continuous operation, the junction temperature should be maintained below 125°C. The power dissipation is defined as:

$$P_D = (V_{IN} - V_{OUT}) * I_O + V_{IN} * I_{GND}$$

The maximum power dissipation depends on the thermal resistance of IC package, PCB layout, the rate of surrounding airflow and temperature difference between junction and ambient. The maximum power dissipation can be calculated by the following formula:

$$P_{D(MAX)} = (T_{J(MAX)} - T_A) / \theta_{JA}$$

Where $T_{J(MAX)}$ is the maximum allowable junction temperature 125°C, T_A is the ambient temperature and θ_{JA} is the thermal resistance from the junction to the ambient.

For example, as θ_{JA} is 250°C/W for the SOT-23 package and 180°C/W for the SOT-89 package

based on the standard JEDEC 51-3 for a single-layer thermal test board, the maximum power dissipation at $T_A=25^\circ\text{C}$ can be calculated by following formula:

$$P_{D(MAX)} = (125^\circ\text{C} - 25^\circ\text{C}) / 250 = 0.4\text{W} \quad \text{SOT-23}$$

$$P_{D(MAX)} = (125^\circ\text{C} - 25^\circ\text{C}) / 180 = 0.55\text{W} \quad \text{SOT-89}$$

It is also useful to calculate the junction temperature of the PAM3106 under a set of specific conditions. For example, suppose the input voltage $V_{IN}=3.3\text{V}$, the output current $I_O=300\text{mA}$ and the case temperature $T_A=40^\circ\text{C}$ measured by a thermocouple during operation, the power dissipation for the $V_O=2.8\text{V}$ version of the PAM3106 can be calculated as:

$$P_D = (3.3\text{V} - 2.8\text{V}) * 300\text{mA} + 3.3\text{V} * 90\mu\text{A} \cong 150\text{mW}$$

And the junction temperature, T_J , can be calculated as follows:

$$T_J = T_A + P_D * \theta_{JA}$$

$$T_J = 40^\circ\text{C} + 0.15\text{W} * 250^\circ\text{C}/\text{W}$$

$$= 40^\circ\text{C} + 37.5^\circ\text{C}$$

$$= 77.5^\circ\text{C} < T_{J(MAX)} = 125^\circ\text{C}$$

For this operating condition, T_J is lower than the absolute maximum operating junction temperature, 125°C, so it is safe to use the PAM3106 in this configuration.



Ordering Information

PAM3106 X X X xxx

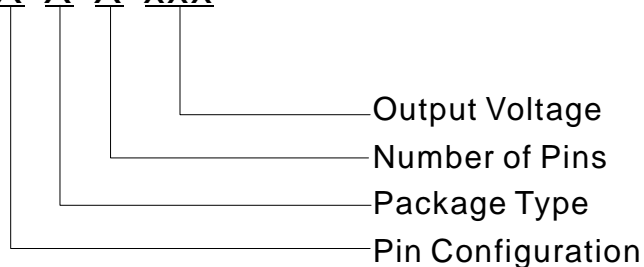

Pin Configuration		Package Type	Number of Pins	Output Voltage
A Type	F Type	A: SOT-23 K:DFN1.6X1.6	A: 3 B: 5 F:6	330: 3.3V 280: 2.8V 250: 2.5V 180: 1.8V 150: 1.5V 120:1.2V
1. GND 2. VOUT 3. VIN C Type 1. VIN 2. GND 3. EN 4. NC 5. VOUT D Type 1. VIN 2. GND 3. EN 4. BYP 5. VOUT	1. EN 2. NC 3. VIN 4.VOUT 5.NC 6.GND			



Ordering Information (continued)

Part Number	Output Voltage	Marking	Package Type	Shipping Package
PAM3106AAA330	3.3V	AFKYW	SOT23-3	3,000Units/Tape&Reel
PAM3106AAA280	2.8V	AFHYW	SOT23-3	3,000Units/Tape&Reel
PAM3106AAA250	2.5V	AFGYW	SOT23-3	3,000Units/Tape&Reel
PAM3106AAA180	1.8V	AFEYW	SOT23-3	3,000Units/Tape&Reel
PAM3106AAA150	1.5V	AFCYW	SOT23-3	3,000Units/Tape&Reel
PAM3106AAA120	1.2V	AFBYW	SOT23-3	3,000Units/Tape&Reel
PAM3106CAB330	3.3V	AFKYW	SOT23-5	3,000Units/Tape&Reel
PAM3106CAB280	2.8V	AFHYW	SOT23-5	3,000Units/Tape&Reel
PAM3106CAB250	2.5V	AFGYW	SOT23-5	3,000Units/Tape&Reel
PAM3106CAB180	1.8V	AFEYW	SOT23-5	3,000Units/Tape&Reel
PAM3106CAB150	1.5V	AFCYW	SOT23-5	3,000Units/Tape&Reel
PAM3106CAB120	1.2V	AFBYW	SOT23-5	3,000Units/Tape&Reel
PAM3106DAB330	3.3V	AFKYW	SOT23-5	3,000Units/Tape&Reel
PAM3106DAB280	2.8V	AFHYW	SOT23-5	3,000Units/Tape&Reel
PAM3106DAB250	2.5V	AFGYW	SOT23-5	3,000Units/Tape&Reel
PAM3106DAB180	1.8V	AFEYW	SOT23-5	3,000Units/Tape&Reel
PAM3106DAB150	1.5V	AFCYW	SOT23-5	3,000Units/Tape&Reel
PAM3106DAB120	1.2V	AFBYW	SOT23-5	3,000Units/Tape&Reel
PAM3106FKF330	3.3V	AFKYW	WDFN1.6X1.6	3,000Units/Tape&Reel
PAM3106FKF280	2.8V	AFHYW	WDFN1.6X1.6	3,000Units/Tape&Reel
PAM3106FKF250	2.5V	AFGYW	WDFN1.6X1.6	3,000Units/Tape&Reel
PAM3106FKF180	1.8V	AFEYW	WDFN1.6X1.6	3,000Units/Tape&Reel
PAM3106FKF150	1.5V	AFCYW	WDFN1.6X1.6	3,000Units/Tape&Reel
PAM3106FKF120	1.2V	AFBYW	WDFN1.6X1.6	3,000Units/Tape&Reel

Outline Dimension

SOT23-5

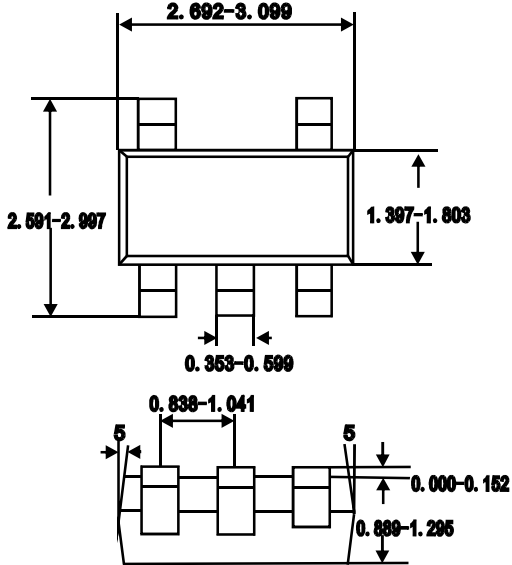

(Unit: mm)

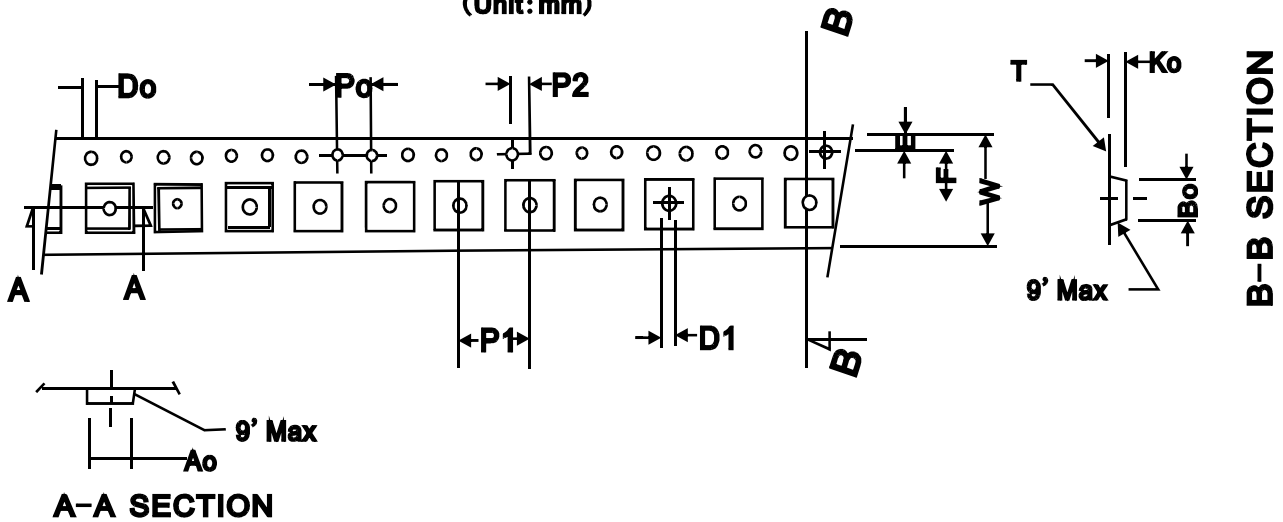

Symbol	Ao	Bo	Ko	Po	P1	P2	T
Spec	3.20±0.1	3.10±0.1	1.40±0.1	4.0±0.1	4.0±0.10	2.0±0.05	0.254±0.013
Symbol	E	F	Do	D1	W	10Po	
Spec	1.75±0.1	3.5±0.05	1.55±0.05	1.0±0.25	8.0+0.3 -0.1	40.0±0.2	

Outline Dimension

WDFN-6L

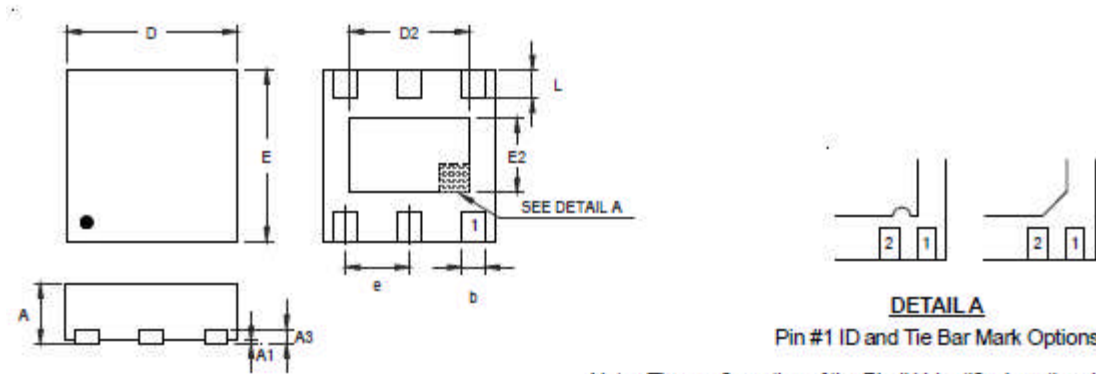

Note : The configuration of the Pin #1 identifier is optional, but must be located within the zone indicated.

Symbol	Dimensions In Millimeters		Dimensions In Inches	
	Min	Max	Min	Max
A	0.700	0.800	0.028	0.031
A1	0.000	0.050	0.000	0.002
A3	0.175	0.250	0.007	0.010
b	0.200	0.300	0.008	0.012
D	1.550	1.650	0.061	0.065
D2	0.950	1.050	0.037	0.041
E	1.550	1.650	0.061	0.065
E2	0.550	0.650	0.022	0.026
e	0.500		0.020	
L	0.190	0.290	0.007	0.011

W-Type 6L DFN 1.6x1.6 Package