



## DDR 13-Bit to 26-Bit Registered Buffer

### Features

- Differential clock signals.
- Meets SSTL\_2 class II specifications on outputs.
- Low voltage operation:  $V_{DD} = 2.3V$  to  $2.7V$ .
- Available in 64-pin TSSOP, 64-pin TVSOP, and 56-pin VFQFN packages.

### Product Description

The ASM4SSTVF16859 is a universal 13/26 bit register (D F/F based), designed for 2.3V to 2.7V  $V_{DD}$  operation. The device supports SSTL\_2 I/O levels, and is fully compliant with the JEDEC JC40, JC42.5 DDR I specifications covering PC1600, PC2100, PC2700, and PC3200 operational ranges (DDR 400 – 200 MHz). 13/26 bits refers to 2Q outputs for each D input - designed for use in Stacked Registered (stacked Memory Devices), Buffered DIMM applications.

Data flow from D to Q is controlled by the differential clock (CLK/CLKB) and a control signal (RESETB). The positive edge of CLK is used to trigger the data transfer, and CLKB is used to maintain sufficient noise margins, whereas RESETB input is designed and intended for use at power-up.

The ASM4SSTVF16859 supports a low power standby mode of operation. A logic level low at RESETB, assures that all internal registers and outputs (Q) are reset to a logic low state, and that all input receivers, data (D) buffers, and clock (CLK/CLKB) are switched

off. Note that RESETB should be supported with a LVCMOS level at a valid state since VREF may not be stable during power-up.

To ensure that outputs are at a defined logic state before a stable clock has been supplied, RESETB must be held at a logic low level during power-up.

In the JEDEC defined Registered DDR DIMM application, RESETB is specified to be asynchronous with respect to CLK/CLKB; therefore, no timing relationship can be guaranteed between the two signals. When entering a low-power standby state, the register will be cleared and the outputs will be driven to a logic low level quickly relative to the time to disable the differential input receivers. This ensures there are no “glitches” on any output. However, when coming out of low power standby mode, the register will become active quickly relative to the time taken to enable the differential input receivers. When the data inputs are at a logic level low and the clock is stable during the low-to-high transition of RESETB until the input receivers are fully enabled, the design ensures that the outputs will remain at a logic low level.

### Applications

- JEDEC and Non-JEDEC DDR Memory Modules
  - Stacked or Planar configurations.
  - Supports PC1600 - PC2100 - PC2700 - PC3200
    - DDR 400 compliant (200MHz+).
- SSTL\_2 I/O.
- Provides a complete support solution for JEDEC JC42.5 DIMMs' when used with the ASM5CVF857 Zero Delay Buffer.



rev 2.0

Block Diagram

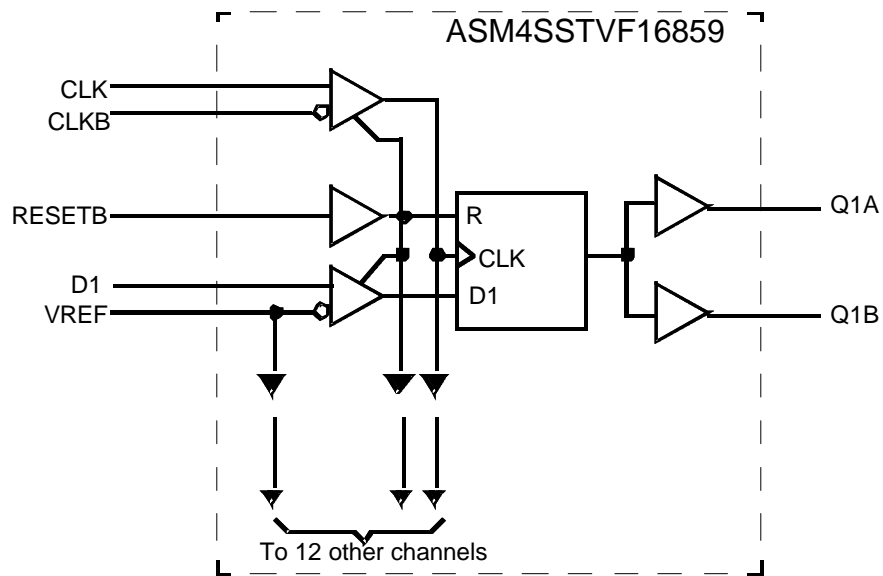



rev 2.0

Pin Configurations

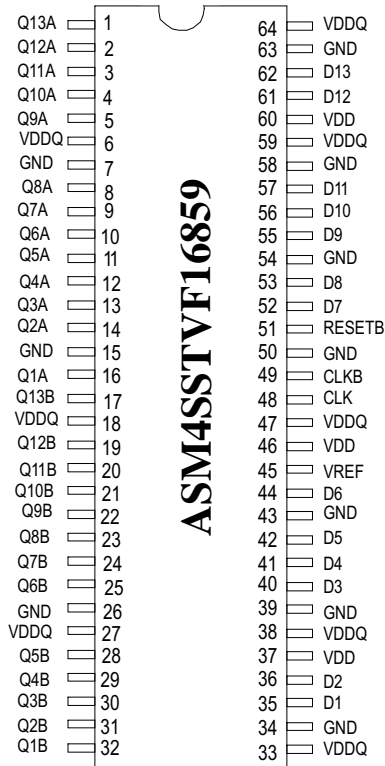

64-pin TSSOP

6.10 mm body, 0.50 mm pitch

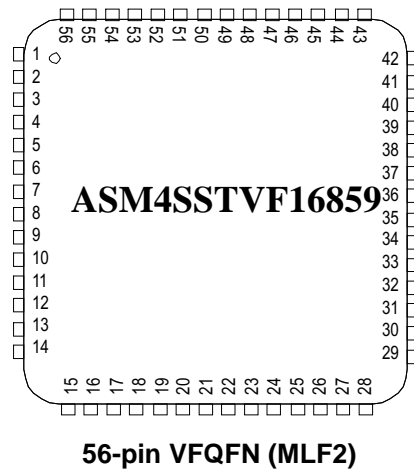



## Pin Descriptions

### 64-pin TSSOP

Pin #	Pin Name	Type	Description
1, 2, 3, 4, 5, 8, 9, 10, 11, 12, 13, 14, 16, 17, 19, 20, 21, 22, 23, 24, 25, 28, 29, 30, 31, 32	Q (13:1)	O	Data output.
7, 15, 26, 34, 39, 43, 50, 54, 58, 63	GND	P	Ground to entire chip.
6, 18, 27, 33, 38, 47, 59, 64	VDDQ	P	Output supply voltage, 2.5V nominal.
35, 36, 40, 41, 42, 44, 52, 53, 55, 56, 57, 61, 62	D(13:1)	I	Data input.
48	CLK	I	Positive master clock input.
49	CLKB	I	Negative master clock input.
37, 46, 60	VDD	P	Core supply voltage, 2.5V nominal.
51	RESETB	I	Rest Active low.
45	VREF	I	Input reference voltage, 1.25V nominal.

### 56-pin MLF2

Pin #	Pin Name	Type	Description
1, 2, 3, 4, 5, 6, 7, 8, 10, 11, 12, 13, 14, 15, 16, 18, 19, 20, 21, 22, 50, 51, 52, 53, 54, 56	Q (13:1)	O	Data output.
37, 48	GND	P	Ground to entire chip.
9, 17, 23, 27, 34, 44, 49, 55	VDDQ	P	Output supply voltage, 2.5V nominal.
24, 25, 28, 29, 30, 31, 39, 40, 41, 42, 43, 46, 47	D(13:1)	I	Data input.
35	CLK	I	Positive master clock input.
36	CLKB	I	Negative master clock input.
26, 33, 45	VDD	P	Core supply voltage, 2.5V nominal.
38	RESETB	I	Rest Active low.
32	VREF	I	Input reference voltage, 1.25V nominal.
-	Center Pad	P	Ground (VFQFN package only)



rev 2.0

## Truth Table

Inputs				Q Outputs
RESETB	CLK	CLKB	D	Q
L	X or floating	X or floating	X or floating	L
H			H	H
H			L	L
H	L or H	L or H	X	$Q_0^2$

Note:

1. H=High signal level, L=Low signal level, = transition from low to high, = transition from high to low, X = don't care
2. Output level before the indicated steady state input conditions were established.

1

## Absolute Maximum Ratings

Parameter	Min	Max	Unit
Storage Temperature	-65	+150	°C
Supply Voltage	-0.5	3.6	V
Input Voltage <sup>1</sup>	-0.5	$V_{DD} + 0.5$	V
Output Voltage <sup>1,2</sup>	-0.5	$V_{DD} + 0.5$	V
Input Clamp Current	± 50		mA
Output Clamp Current	±50		mA
Continuous Output Current	±50		mA
VDD, VDDQ or GND current/pin	100		mA
Package Thermal Impedance <sup>3</sup>	55		°C/W

Note:

1. The input and output negative voltage ratings may be excluded if the input and output clamp ratings are observed.
2. This current will flow only when the output is in the high state level  $V_o > V_{DDQ}$ .
3. The package thermal impedance is calculated in accordance with JESD 51.

These are stress ratings only and functional operation is not implied. Exposure to absolute maximum ratings for prolonged periods can affect device reliability.



rev 2.0

**Recommended Operating Conditions - DDRI / DDR333 (PC1600, PC2100, PC2700)\***

Parameter	Description	Min	Typ	Max	Unit
V <sub>DD</sub>	Supply voltage	2.3	2.5	2.7	V
V <sub>DDQ</sub>	I/O supply voltage	2.3	2.5	2.7	V
V <sub>REF</sub>	Reference voltage	1.15	1.25	1.35	V
V <sub>TT</sub>	Termination voltage	V <sub>REF</sub> - 0.04	V <sub>REF</sub>	V <sub>REF</sub> + 0.004	V
V <sub>I</sub>	Input voltage	0		V <sub>DD</sub>	V
V <sub>IH(DC)</sub>	DC input high voltage	Data Inputs	V <sub>REF</sub> + 0.15		V
V <sub>IH(AC)</sub>	AC input high voltage		V <sub>REF</sub> + 0.31		V
V <sub>IL(DC)</sub>	DC input low voltage			V <sub>REF</sub> - 0.15	V
V <sub>IL(AC)</sub>	AC input low voltage			V <sub>REF</sub> - 0.31	V
V <sub>IH</sub>	Input high voltage level	RESETB	1.7		V
V <sub>IL</sub>	Input low voltage level			0.7	V
V <sub>ICR</sub>	Common mode input range	CLK	0.97	1.53	V
V <sub>ID</sub>	Differential input voltage	CLKB	0.36		V
V <sub>IX</sub>	Cross-point voltage of differential clock pair		(V <sub>DDQ</sub> /2) - 0.2	(V <sub>DDQ</sub> /2) + 0.2	V
I <sub>OH</sub>	High-level output current			-20	mA
I <sub>OI</sub>	Low-level output current			20	mA
T <sub>A</sub>	Operating free-air temperature		0	70	°C

**Recommended Operating Conditions - DDRI-400 (PC3200)\***

Parameter	Description	Min	Typ	Max	Units
V <sub>DD</sub>	Supply Voltage	2.5	2.6	2.7	V
V <sub>DDQ</sub>	I/O supply voltage	2.5	2.6	2.7	V
V <sub>REF</sub>	Reference voltage	1.25	1.3	1.35	V
V <sub>TT</sub>	Termination voltage	V <sub>REF</sub> - 0.04	V <sub>REF</sub>	V <sub>REF</sub> + 0.04	V
V <sub>I</sub>	Input voltage	0		V <sub>DDQ</sub>	V
V <sub>IH(DC)</sub>	DC input high voltage	Data Inputs	V <sub>REF</sub> + 0.15		V
V <sub>IH(AC)</sub>	AC input high voltage		V <sub>REF</sub> + 0.31		V
V <sub>IL(DC)</sub>	DC input low voltage			V <sub>REF</sub> - 0.15	V
V <sub>IL(AC)</sub>	AC input low voltage			V <sub>REF</sub> - 0.31	V
V <sub>IH</sub>	Input high voltage level	RESETB	1.7		V
V <sub>IL</sub>	Input low voltage level			0.7	V
V <sub>ICR</sub>	Common mode input range	CLK, CLKB	0.97	1.53	V
V <sub>ID</sub>	Differential input voltage		0.36		V
V <sub>IX</sub>	Cross-point voltage of differential clock pair		(V <sub>DDQ</sub> /2) - 0.2	(V <sub>DDQ</sub> /2) + 0.2	V
I <sub>OH</sub>	High-level output current			-16	mA
I <sub>OL</sub>	Low-level output current			16	mA
T <sub>A</sub>	Operating free-air temperature		0	70	°C



## rev 2.0

\* Guaranteed by design. Not 100% production tested.

### DC Electrical Characteristics - DDRI / DDR333 (PC1600, PC2100, PC2700)

$T_A = 0^\circ\text{C}$  to  $70^\circ\text{C}$ ,  $V_{DD} = 2.5 \pm 0.2\text{V}$ , and  $V_{DDQ} = 2.5 \pm 0.2\text{V}$  (unless otherwise stated)

Guaranteed by design. Not 100% production tested.

Symbol	Parameters	Test conditions	$V_{DD}$	Min	Typ	Max	Units
$V_{IK}$		$I_I = -18\text{ mA}$	2.3 V			-1.2	V
$V_{OH}$		$I_{OH} = -100\ \mu\text{A}$	2.3 V to 2.7 V	$V_{DD} - 0.2$			V
		$I_{OH} = -16\text{ mA}$	2.3 V	1.95			V
$V_{OL}$		$I_{OL} = 100\ \mu\text{A}$	2.3 V to 2.7 V			0.2	V
		$I_{OL} = 16\text{ mA}$	2.3 V			0.35	V
$I_I$	All inputs	$V_I = V_{DD}$ or GND	2.7 V			$\pm 5$	$\mu\text{A}$
$I_{DD}$	Standby (static)	RESETB = GND	2.7 V			0.01	$\mu\text{A}$
	Operating (static)	$V_I = V_{IH(AC)}$ or $V_{IL(AC)}$ , RESETB = $V_{DD}$	2.7 V			25	mA
$I_{DDD}$	Dynamic operating (clock only)	RESETB = $V_{DD}$ , $V_I = V_{IH(AC)}$ or $V_{IL(AC)}$ , CLK and CLKB switching 50% duty cycle	2.7 V		30		$\mu\text{A}/\text{clock MHz}$
	Dynamic operating (per each data input)	RESETB = $V_{DD}$ , $V_I = V_{IH(AC)}$ or $V_{IL(AC)}$ , CLK and CLKB = switching 50% duty cycle One data input switching at half clock frequency, 50% duty cycle	2.7 V		10		$\mu\text{A}/\text{clock MHz}/\text{data input}$
$r_{OH}$	Output high	$I_{OH} = -20\text{ mA}$	2.3 V to 2.7 V	7		20	W
$r_{OL}$	Output low	$I_{OL} = 20\text{ mA}$	2.3 V to 2.7 V	7		20	W
$r_{O(D)}$	$ r_{OH} - r_{OL} $ each separate bit	$I_O = 20\text{ mA}$ , $T_A = 25^\circ\text{C}$	2.5 V			4	W
$C_i$	Data inputs	$V_I = V_{REF} \pm 310\text{ mV}$ , $V_{ICR} = 1.25\text{ V}$ , $V_{I(PP)} = 360\text{ mV}$	2.5 V	2.5		3.5	pF
	CLK and CLKB		2.5 V	2.5		3.5	pF
	RESETB	$V_I = V_{DD}$ or GND	2.5V	2.5		3.5	pF



rev 2.0

### DC Electrical Characteristics - DDRI - 400 (PC3200)

$T_A = 0^\circ\text{C}$  to  $70^\circ\text{C}$ ,  $V_{DD} = 2.6 \pm 0.2\text{V}$ , and  $V_{DDQ} = 2.6 \pm 0.2\text{V}$  (unless otherwise stated)

Guaranteed by design. Not 100% production tested.

Symbol	Parameters	Test conditions	$V_{DD}$	Min	Typ	Max	Units
$V_{IK}$		$I_I = -18\text{ mA}$	2.5 V			-1.2	V
$V_{OH}$		$I_{OH} = -100\ \mu\text{A}$	2.5 V to 2.7 V	$V_{DD} - 0.2$			V
		$I_{OH} = -8\text{ mA}$	2.5 V	1.95			V
$V_{OL}$		$I_{OL} = 100\ \mu\text{A}$	2.5 V to 2.7 V			0.2	V
		$I_{OL} = 8\text{ mA}$	2.5 V			0.35	V
$I_I$	All inputs	$V_I = V_{DD}$ or GND	2.7 V			$\pm 5$	$\mu\text{A}$
$I_{DD}$	Standby (static)	RESETB = GND	2.7 V			0.01	$\mu\text{A}$
	Operating (static)	$V_I = V_{IH(AC)}$ or $V_{IL(AC)}$ , RESETB = $V_{DD}$	2.7 V			25	mA
$I_{DDD}$	Dynamic operating (clock only)	RESETB = $V_{DD}$ , $V_I = V_{IH(AC)}$ or $V_{IL(AC)}$ , CLK and CLKB switching 50% duty cycle	2.7 V		30		$\mu\text{A}/\text{clock MHz}$
	Dynamic operating (per each data input)	RESETB = $V_{DD}$ , $V_I = V_{IH(AC)}$ or $V_{IL(AC)}$ , CLK and CLKB = switching 50% duty cycle; One data input switching at half clock frequency, 50% duty cycle	2.7 V		10		$\mu\text{A}/\text{clock MHz}/\text{data input}$
$r_{OH}$	Output high	$I_{OH} = -16\text{ mA}$	2.5 V to 2.7 V	7		20	W
$r_{OL}$	Output low	$I_{OL} = 16\text{ mA}$	2.5 V to 2.7 V	7		20	W
$r_{O(D)}$	$ r_{OH} - r_{OL} $ each separate bit	$I_O = 20\text{ mA}$ , $T_A = 25^\circ\text{C}$	2.6 V			4	W
$C_i$	Data inputs	$V_I = V_{REF} \pm 310\text{ mV}$ , $V_{ICR} = 1.25\text{ V}$ ,	2.6 V	2.5		3.5	pF
	CLK and CLKB	$V_{I(PP)} = 360\text{ mV}$	2.6 V	2.5		3.5	pF
	RESETB	$V_I = V_{DD}$ or GND	2.6V	2.5		3.5	pF





rev 2.0

## Timing Requirements\*\*

Guaranteed by design. Not 100% production tested.

Symbol	Parameters	V <sub>DDQ</sub> = 2.5V±0.2V		V <sub>DDQ</sub> = 2.6V±0.1V		Units
		Min	Max	Min	Max	
f <sub>CLOCK</sub>	Clock frequency		200		270	MHz
t <sub>W</sub>	Pulse duration, CK, CKLB high or low	2.5		2.5		ns
t <sub>ACT</sub> *	Differential inputs active time		22		22	ns
t <sub>INACT</sub> *	Differential inputs inactive time		22		22	ns
t <sub>s</sub>	Setup time, fast slew rate	Data before CLK↑, CLKB↓	0.75		0.4	ns
	Setup time, slow slew rate		0.9		0.6	
t <sub>h</sub>	Hold time, fast slew rate	Data after CLK↑, CLKB↓	0.75		0.4	ns
	Hold time, slow slew rate		0.9		0.6	

Note:  
 1. Data inputs must be low for a minimum time of t<sub>ACT</sub> max, after which RESETB is taken high.  
 2. Data and clock inputs must be held at valid levels (not floating) for a minimum time of t<sub>INACT</sub> max after which RESETB is taken low.  
 3. For data signal input slew rate ≥V/ns  
 4. For data signal input slew rate ≥0.5 V/ns and < 1V/ns  
 5. CLK,CLKB signals input slew rates are ≥1V/ns

## Switching Characteristics - DDRI / DDR333 (PC1600, PC2100, PC2700)\*\*

Symbol	From (input)	To (output)	VDD = 2.5 V ± 0.2 V			Units
			Min	Typ	Max	
f <sub>max</sub>			200	–	–	MHz
t <sub>PD</sub>	CLK, CLKB (TSSOP)	Q	1.1		2.8	ns
	CLK, CLKB (VFQFN[MLF2])	Q	1.1		2.8	ns
t <sub>phl</sub>	RESETB	Q	–	–	5.0	ns

## Switching Characteristics - DDRI-400 (PC3200)\*\*

Symbol	From (input)	To (output)	VDD = 2.6 V ± 0.1 V			Units
			Min	Typ	Max	
f <sub>max</sub>			210			MHz
t <sub>PD</sub>	CLK, CLKB (VFQFN[MLF2]) Simultaneous switching	Q	1.1		2.2	ns
t <sub>PDSS</sub>		Q			2.48	ns
t <sub>phl</sub>	RESETB	Q			3.5	ns

\*this parameter is not necessarily production tested.

\*\*Over recommended operating free-air temperature range unless otherwise noted.



rev 2.0

Parameter Measurement Information ( $V_{DD} = 2.5\text{ V} \pm 0.2\text{ V}$ )

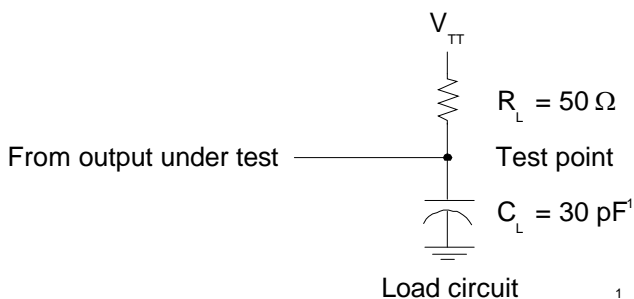

<sup>1</sup>  $C_L$  includes probe and jig capacitance.

**Voltage and Current Waveforms**

In the following waveforms, note that all input pulses are supplied by generators having the following characteristics: PRR 10 MHz,  $Z_o = 50\ \Omega$ , input slew rate =  $1\text{ V/ns} \pm 20\%$  (unless otherwise specified).

The outputs are measured one at a time with one transition per measurement.

$V_{TT} = V_{REF} = V_{DDQ}/2.$

$V_{IH} = V_{REF} + 310\text{ mV}$  (AC voltage levels) for differential inputs.  $V_{IH} = V_{DD}$  for LVCMOS input.

$V_{IL} = V_{REF} - 310\text{ mV}$  (AC voltage levels) for differential inputs.  $V_{IL} = \text{GND}$  for LVCMOS input.

$t_{PLH}$  and  $t_{PHL}$  are the same as  $t_{pd}$ .

**Input active and inactive times**

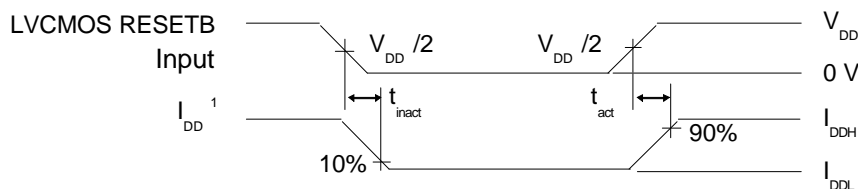

<sup>1</sup>  $I_{DD}$  tested with clock and data inputs held at  $V_{DD}$  or GND, and  $I_o = 0\text{ mA}$ .

**Pulse duration**

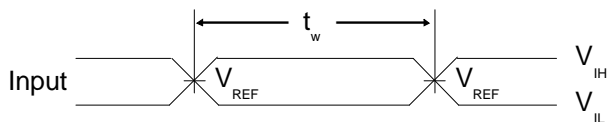

**Setup and hold times**

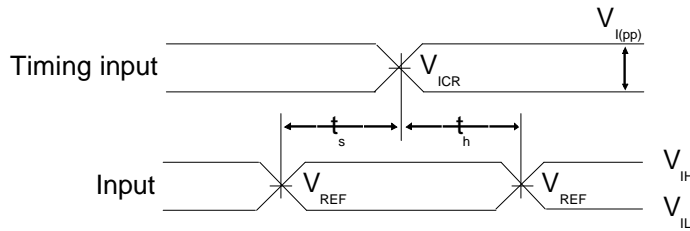

**Propagation delay times**

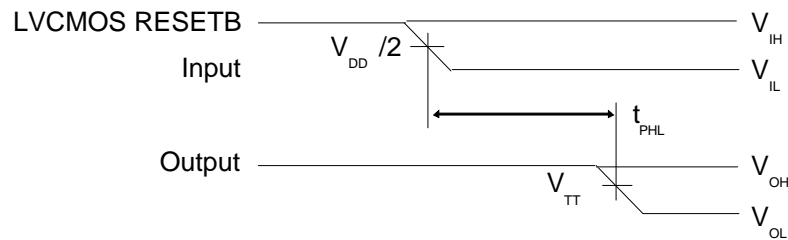
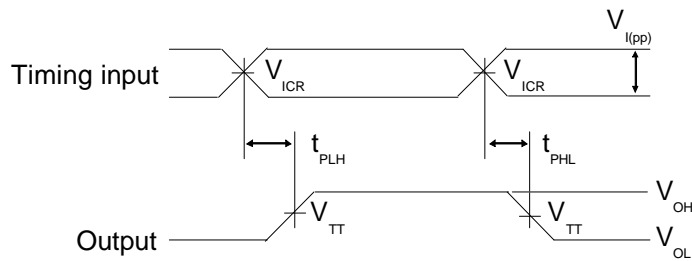

**Output slew rates over recommended operating free-air temperature range (unless otherwise noted)**

Parameter	From	To	$V_{CC} = 2.5 V \pm 0.2V *$		$V_{CC} = 2.6 V \pm 0.1 V *$		Unit
			Min	Max	Min	Max	
dV/dt_r	20%	80%	1	4	1	4	V/ns
dV/dt_f	80%	20%	1	4	1	4	V/ns
dV/dt_Δ**	20% or 80%	80% or 20%		1		1	V/ns

\*For this test condition,  $V_{DDQ}$  is always equal to  $V_{DD}$

\*\*Difference between dV/dt\_r (rising edge rate) and dV/dt\_f (falling edge rate)





rev 2.0

Package Dimensions (64- Pin TSSOP)

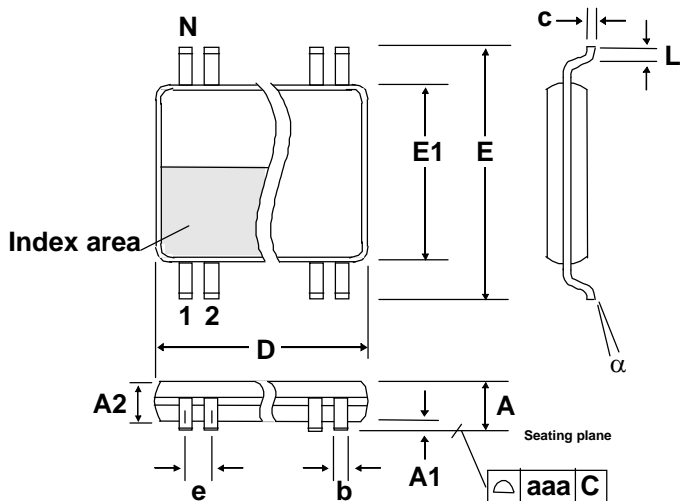

6.10 mm (240 mil) body,  
0.50 mm (0.020 mil) pitch TSSOP

Symbol	Millimeters		Inches	
	Min	Max	Min	Max
A	-	1.20	-	0.047
A1	0.05	0.15	0.002	0.006
A2	0.80	1.05	0.32	0.041
b	0.17	0.27	0.007	0.011
c	0.09	0.20	0.0035	0.008
D	See variations below			
E	8.10 basic		0.319 basic	
E1	6.00	6.20	0.236	0.244
e	0.50 basic		0.020 basic	
L	0.45	0.75	0.018	0.030
N	See variations below			
a	0°	8°	0°	8°
aaa	-	0.10	-	0.004

Variations:

N	D (mm)		D (inch)	
	Min	Max	Min	Max
64	16.90	17.10	0.665	0.673



rev 2.0

Package Dimensions (56-Pin MLF2)

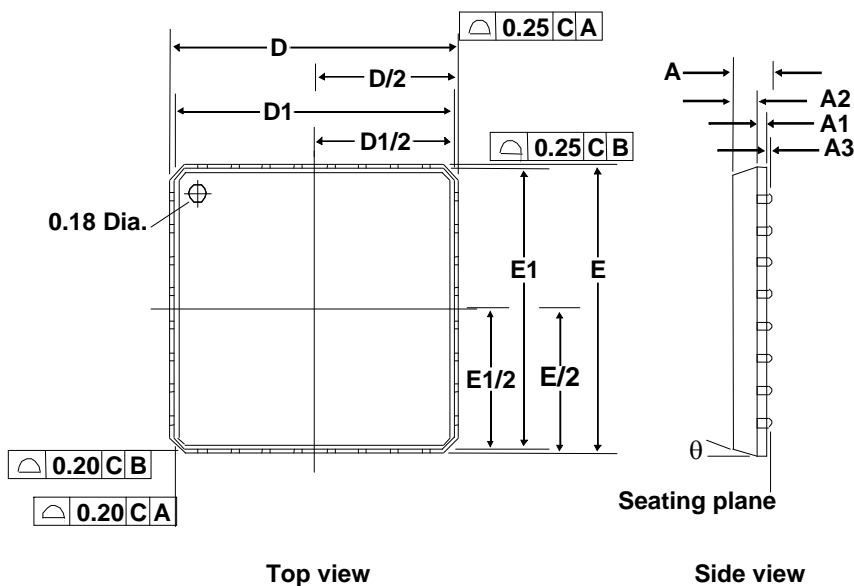

Symbol	Common dimensions		
	Min	Typ	Max
A		0.85	1.00
A1	0.00	0.01	0.05
A2		0.65	0.80
A3	0.20 BSC		
D	8.00 BSC		
D1	7.75 BSC		
E	8.00 BSC		
E1	7.75 BSC		
q			12
P	0.24	0.42	0.60
R	0.13	0.17	0.23
Pitch variation D			
e	0.50 BSC		
N	56		
Nd	14		
Ne	14		
L	0.30	0.40	0.50
b	0.18	0.23	0.30
Q	0.00	0.20	0.45
D2	4.35	4.50	4.65
E2	5.05	5.20	5.35

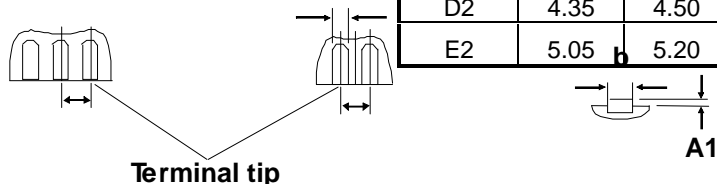
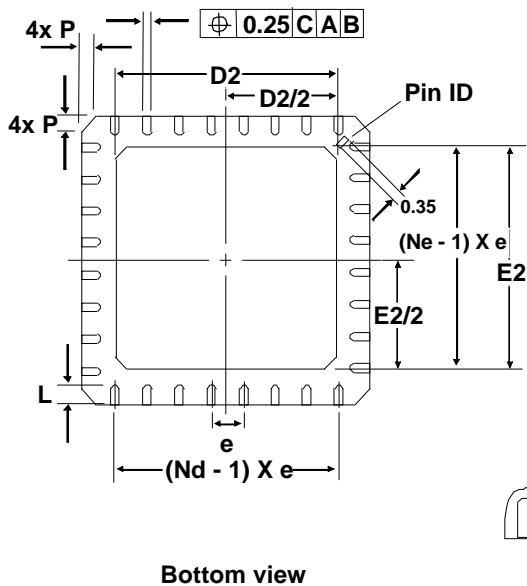

For odd terminal/side    For even terminal/side    Cross section



rev 2.0

**Ordering Information**

Ordering Number	Marking	Package	Qty per Reel	Temperature
ASM4SSTVF16859-64TT	AS4SSTVF16859T	64-Pin TSSOP, Tube		0°C to 70°C
ASM4SSTVF16859-64TR	AS4SSTVF16859T	64-Pin TSSOP, Tape & Reel	2500	0°C to 70°C
ASM4SSTVF16859-56QT	AS4SSTVF16859Q	56-pin MLF2 - VQFN, Tube		0°C to 70°C
ASM4SSTVF16859-56QR	AS4SSTVF16859Q	56-pin MLF2 - VQFN, Tape & Reel	2500	0°C to 70°C



Alliance Semiconductor Corporation  
2595, Augustine Drive,  
Santa Clara, CA 95054  
Tel# 408-855-4900  
Fax: 408-855-4999  
www.alsc.com

Copyright © Alliance Semiconductor  
All Rights Reserved  
Advance Information  
Part Number: ASM4SSTVF16859  
Document Version: v2.0

© Copyright 2004 Alliance Semiconductor Corporation. All rights reserved. Our three-point logo, our name and Intelliwatt are trademarks or registered trademarks of Alliance. All other brand and product names may be the trademarks of their respective companies. Alliance reserves the right to make changes to this document and its products at any time without notice. Alliance assumes no responsibility for any errors that may appear in this document. The data contained herein represents Alliance's best data and/or estimates at the time of issuance. Alliance reserves the right to change or correct this data at any time, without notice. If the product described herein is under development, significant changes to these specifications are possible. The information in this product data sheet is intended to be general descriptive information for potential customers and users, and is not intended to operate as, or provide, any guarantee or warranty to any user or customer. Alliance does not assume any responsibility or liability arising out of the application or use of any product described herein, and disclaims any express or implied warranties related to the sale and/or use of Alliance products including liability or warranties related to fitness for a particular purpose, merchantability, or infringement of any intellectual property rights, except as express agreed to in Alliance's Terms and Conditions of Sale (which are available from Alliance). All sales of Alliance products are made exclusively according to Alliance's Terms and Conditions of Sale. The purchase of products from Alliance does not convey a license under any patent rights, copyrights; mask works rights, trademarks, or any other intellectual property rights of Alliance or third parties. Alliance does not authorize its products for use as critical components in life-supporting systems where a malfunction or failure may reasonably be expected to result in significant injury to the user, and the inclusion of Alliance products in such life-supporting systems implies that the manufacturer assumes all risk of such use and agrees to indemnify Alliance against all claims arising from such use.