



2.0Amp. Surface Mount Schottky Barrier Diodes SK2XSA Series

Features

- For surface mounted applications.
- For use in low voltage, high frequency inverters, free wheeling, and polarity protection applications
- Plastic material used carries Underwriters Laboratory Flammability Classification 94V-0
- Low leakage current
- High surge capability
- High temperature soldering: 250°C/10 seconds at terminals
- Exceeds environmental standards of MIL-S-19500/228

Mechanical Data

- Case: SMA/DO-214AC molded plastic.
- Terminals: Solder plated, solderable per MIL-STD-750 method 2026
- Polarity: Indicated by cathode band.
- Packaging: 12mm tape per EIA STD RS-481.
- Weight: 0.064 gram, 0.002 ounce

Ordering Information

Device	Package	Shipping	Marking
SK24SA-0-T4-G	SMA (Pb-free lead plating and halogen-free package)	7500 pcs / Tape & Reel	SK24
SK26SA-0-T4-G			SK26
SK28SA-0-T4-G			SK28
SK2BSA-0-T4-G			SK2B
SK2CSA-0-T4-G			SK2C
SK2DSA-0-T4-G			SK2D

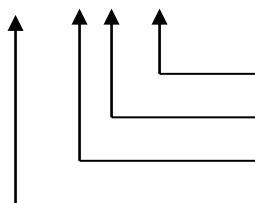

Environment friendly grade : S for RoHS compliant products, G for RoHS compliant and green compound products
 Packing spec, T4 : 7500 pcs / tape & reel, 13" reel
 Product rank, zero for no rank products
 Product name

Maximum Ratings and Electrical Characteristics

(Rating at 25°C ambient temperature unless otherwise specified.)

Parameter	Symbol	Type						Units
		SK24	SK26	SK28	SK2B	SK2C	SK2D	
Repetitive peak reverse voltage	V_{RRM}	40	60	80	100	150	200	V
Maximum RMS voltage	V_{RMS}	28	42	56	70	105	140	V
Maximum DC blocking voltage	V_R	40	60	80	100	150	200	V
Maximum instantaneous forward voltage, $I_F=2A$ (Note 1)	V_F	0.7	0.7	0.85	0.85	0.9	0.9	V
Average forward rectified current	I_O	2						A
Peak forward surge current @8.3ms single half sine wave superimposed on rated load (JEDEC method)	I_{FSM}	50						A
Maximum DC reverse current $V_R=V_{RRM}, T_A=25^\circ C$ (Note 1) $V_R=V_{RRM}, T_A=100^\circ C$ (Note 1)	I_R	0.5 50						mA mA
Maximum thermal resistance, Junction to ambient (Note 2)	$R_{\theta JA}$	80						$^\circ C/W$
Maximum thermal resistance, Junction to case	$R_{\theta JC}$	32						
Power dissipation	P_D	$T_A=25^\circ C$ (Note 2)						W
		$T_C=25^\circ C$						
Diode junction capacitance @ $f=1MHz$ and applied 4V reverse voltage	C_J	110 (typ)						pF
Storage temperature	T_{stg}	-65 ~ +150						$^\circ C$
Operating temperature	T_J	-65 ~ +150			-65 ~ +175			$^\circ C$

Notes : 1.Pulse test, pulse width=300 μ sec, 2% duty cycle

2.Mounted on PCB with 14mm²(0.013mm thickness) copper pad area.

Recommended soldering footprint

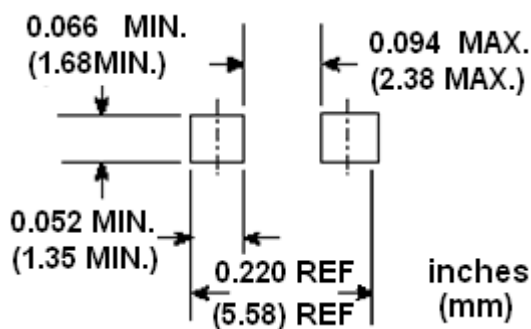

Typical Characteristics

FIG. 1-FORWARD CURRENT DERATING CURVE

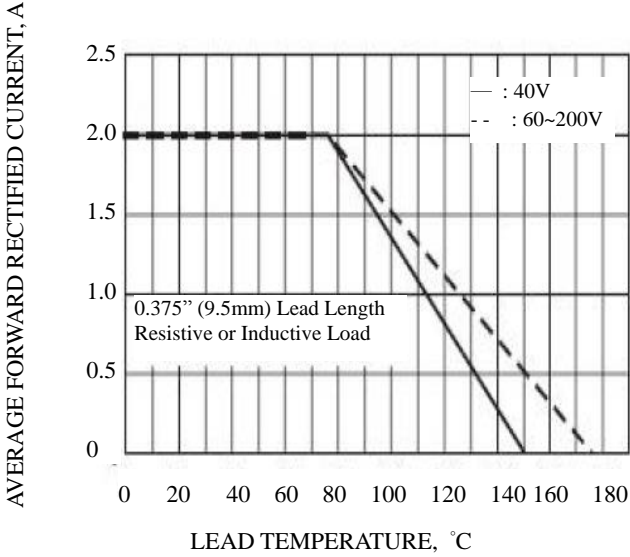

FIG.2-MAXIMUM NON-REPETITIVE SURGE CURRENT

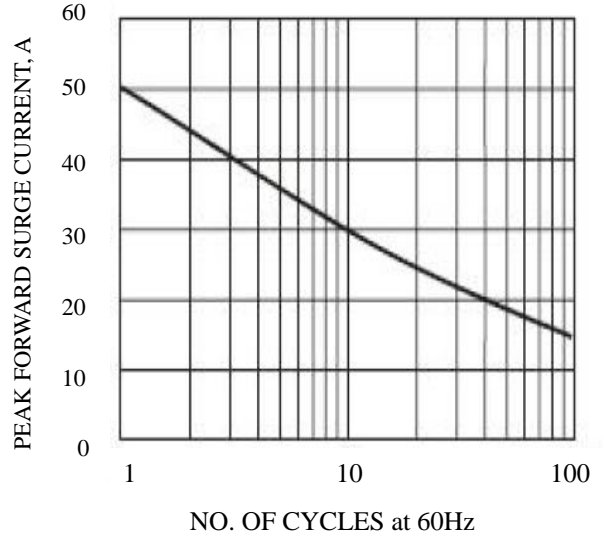

FIG.3- TYPICAL REVERSE CHARACTERISTICS

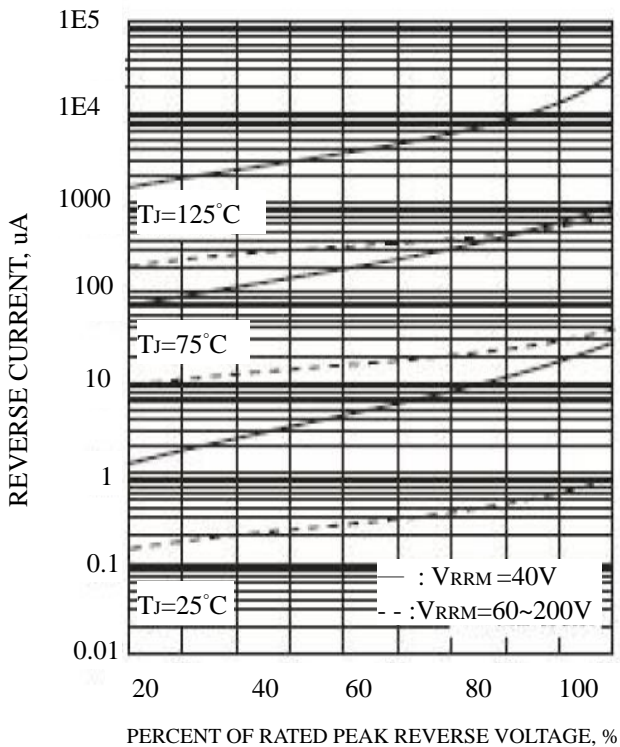
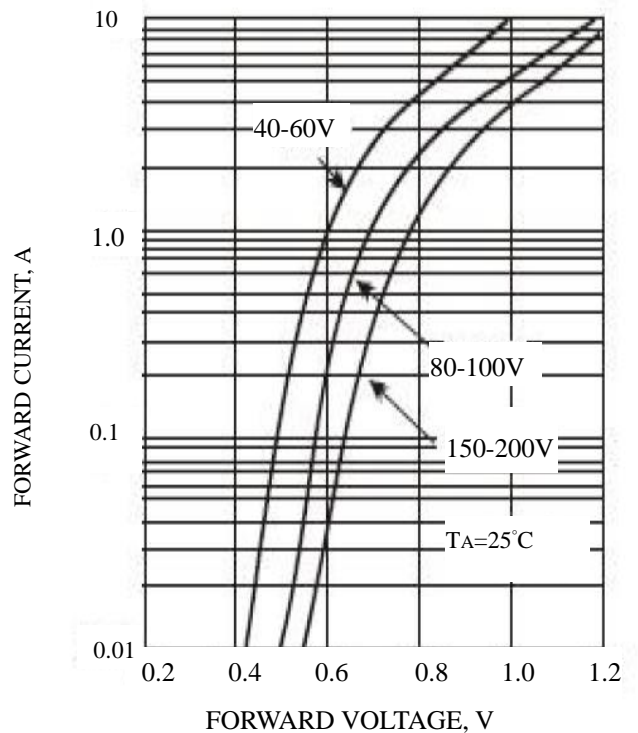
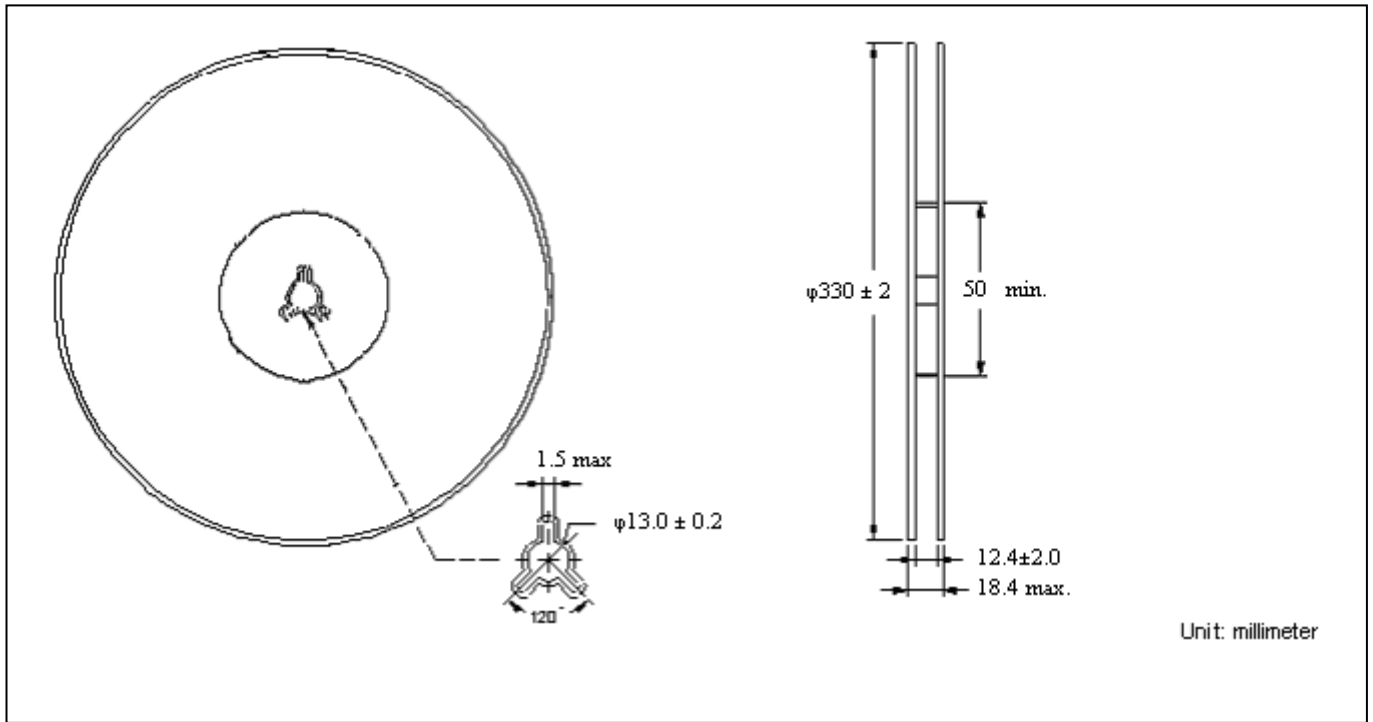

FIG. 4- TYPICAL FORWARD CHARACTERISTICS



Reel Dimension



Carrier Tape Dimension

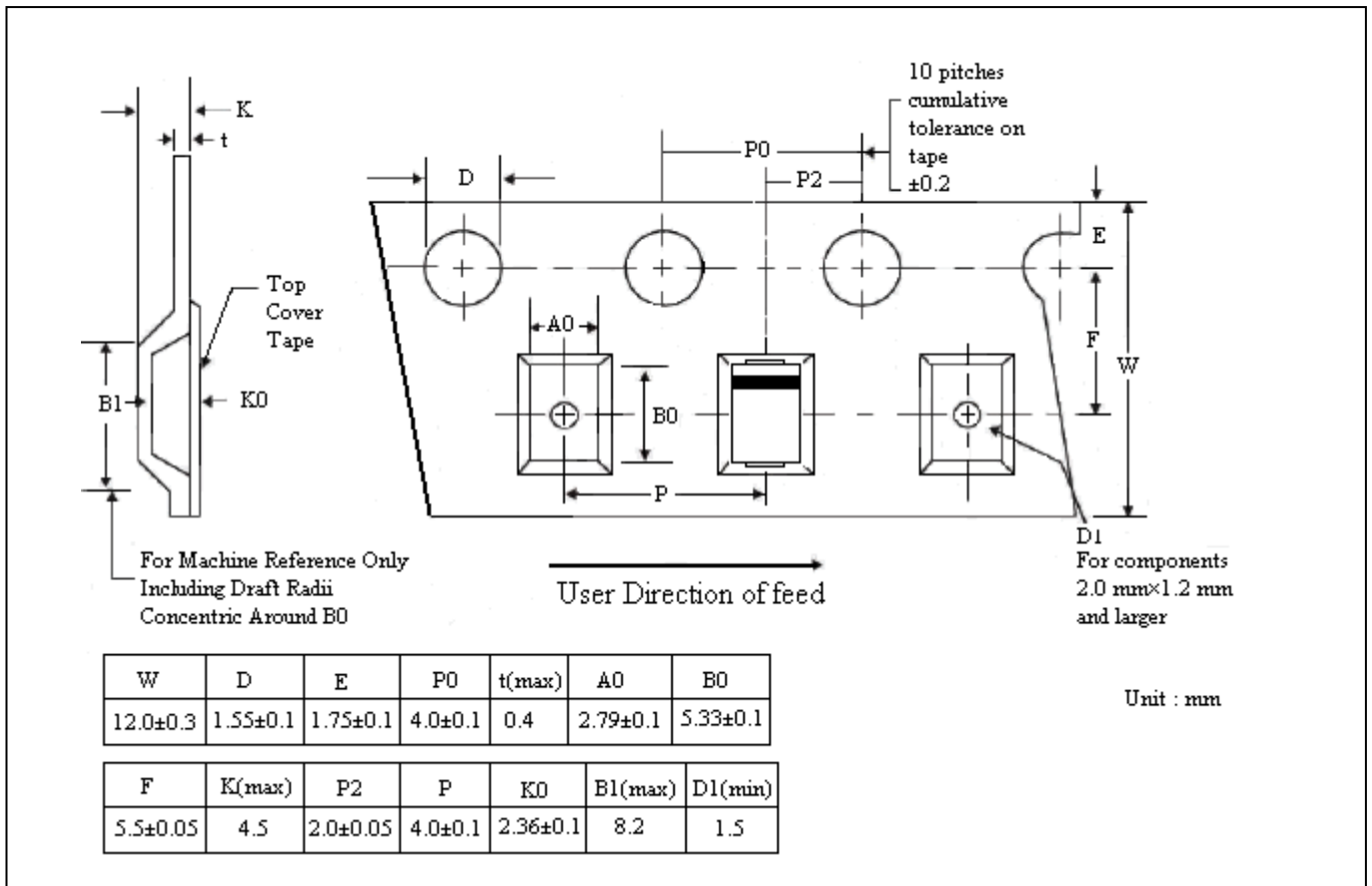

Recommended wave soldering condition

Product	Peak Temperature	Soldering Time
Pb-free devices	265 +0/-5 °C	5 +1/-1 seconds

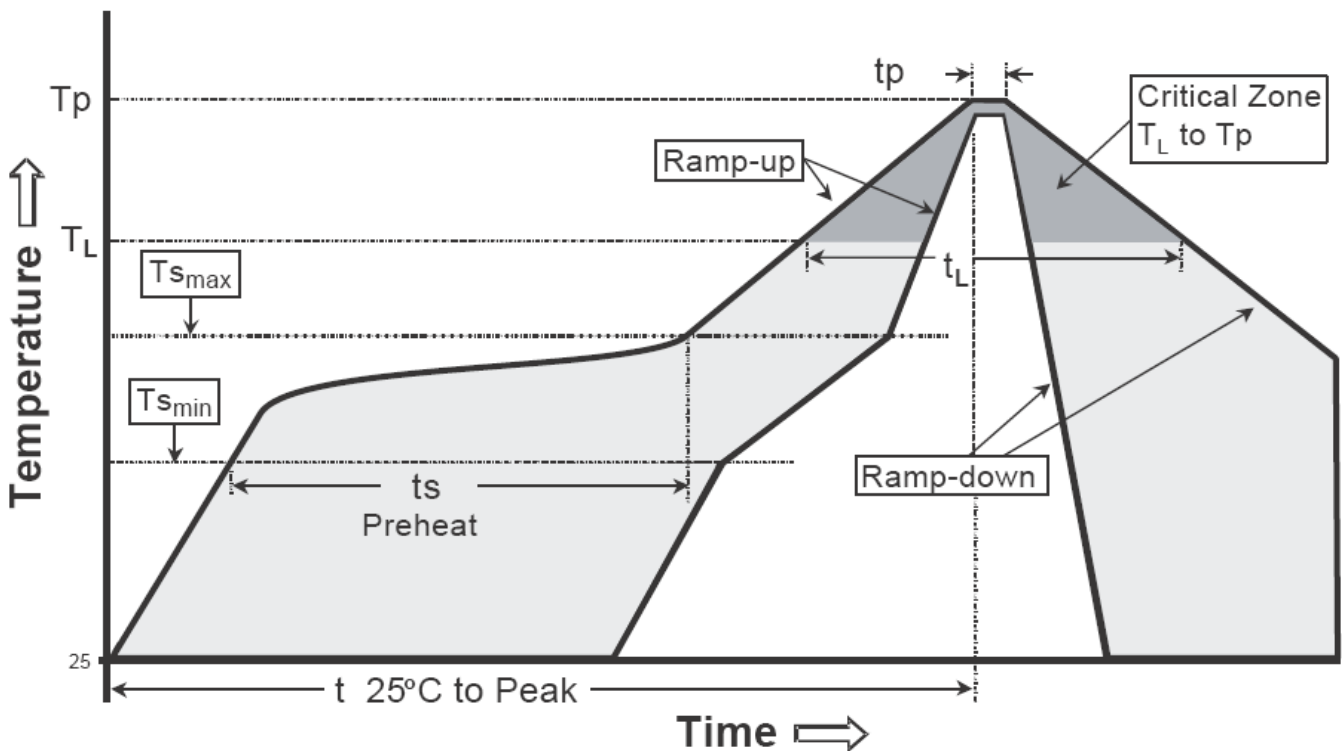
Recommended temperature profile for IR reflow

Profile feature	Sn-Pb eutectic Assembly	Pb-free Assembly
Average ramp-up rate (Tsmax to Tp)	3°C/second max.	3°C/second max.
Preheat		
-Temperature Min(Ts min)	100°C	150°C
-Temperature Max(Ts max)	150°C	200°C
-Time(ts min to ts max)	60-120 seconds	60-180 seconds
Time maintained above:		
-Temperature (TL)	183°C	217°C
- Time (tL)	60-150 seconds	60-150 seconds
Peak Temperature(Tp)	240 +0/-5 °C	265 +0/-5 °C
Time within 5°C of actual peak temperature(tp)	10-30 seconds	20-40 seconds
Ramp down rate	6°C/second max.	6°C/second max.
Time 25 °C to peak temperature	6 minutes max.	8 minutes max.

Note : All temperatures refer to topside of the package, measured on the package body surface.

SMA/DO-214AC Dimension

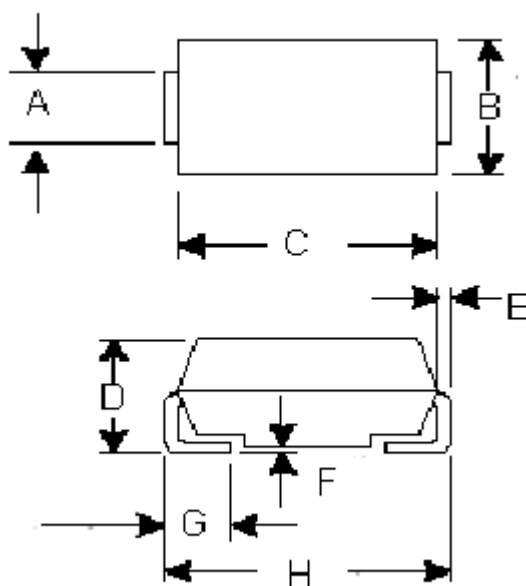

Marking :			
Device	SK24SA	SK26SA	SK28SA
Code	SK24	SK26	SK28
Device	SK2BSA	SK2CSA	SK2DSA
Code	SK2B	SK2C	SK2D

SMA/DO-214AC Plastic
 Surface Mounted Package
 CYStek Package Code : SA

*:Typical

DIM	Inches		Millimeters		DIM	Inches		Millimeters	
	Min.	Max.	Min.	Max.		Min.	Max.	Min.	Max.
A	0.052	0.062	1.32	1.60	E	0.006	0.012	0.15	0.31
B	0.098	0.114	2.50	2.90	F	0.002	0.008	0.05	0.20
C	0.154	0.181	3.90	4.60	G	0.030	0.060	0.76	1.52
D	0.067	0.091	1.70	2.30	H	0.188	0.208	4.80	5.28

Notes : 1.Controlling dimension : millimeters.
 2.Maximum lead thickness includes lead finish thickness, and minimum lead thickness is the minimum thickness of base material.
 3.If there is any question with packing specification or packing method, please contact your local CYStek sales office.

Material :

- Lead : Pure tin plated.
- Mold Compound : Epoxy resin family, flammability solid burning class:UL94V-0.

Important Notice:

- All rights are reserved. Reproduction in whole or in part is prohibited without the prior written approval of CYStek.
- CYStek reserves the right to make changes to its products without notice.
- CYStek **semiconductor products are not warranted to be suitable for use in Life-Support Applications, or systems.**
- CYStek assumes no liability for any consequence of customer product design, infringement of patents, or application assistance.