

SHINDENGEN

Schottky Rectifiers (SBD)

Single

D1NS6

60V 1A

FEATURES

- Tj150°C
- P_{RRSM} avalanche guaranteed
- 5 mm pitch mounting applicable

APPLICATION

- Switching power supply
- DC/DC converter
- Home Appliances, Office Equipment
- Telecommunication

OUTLINE DIMENSIONS

Case : AX057

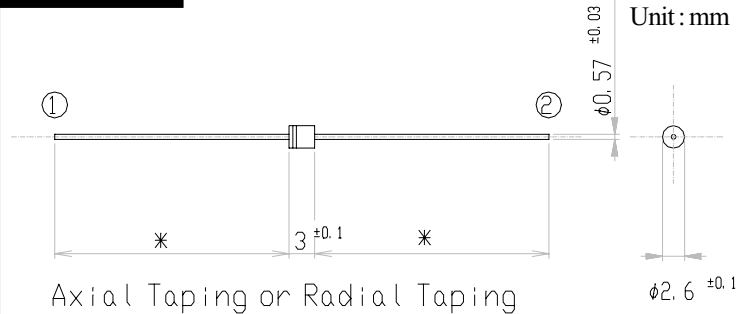

- *Taping Code No. 4000:20^{MIN}
 No. 4060:27^{MIN}
 No. 4070:15^{MIN}

RATINGS

● Absolute Maximum Ratings (If not specified T_i=25°C)

Item	Symbol	Conditions	Ratings	Unit
Storage Temperature	T _{stg}		-55~150	°C
Operating Junction Temperature	T _j		150	°C
Maximum Reverse Voltage	V _{RM}		60	V
Repetitive Peak Surge Reverse Voltage	V _{RRSM}	Pulse width 0.5ms, duty 1/40	65	V
Average Rectified Forward Current	I _o	50Hz sine wave, T _a =46°C	1	A
Peak Surge Forward Current	I _{FSM}	50Hz sine wave, Non-repetitive 1 cycle peak value, T _j =25°C	30	A
Repetitive Peak Surge Reverse Power	P _{RRSM}	Pulse width 10 μs, T _j =25°C	60	W

● Electrical Characteristics (If not specified T_i=25°C)

Item	Symbol	Conditions	Ratings	Unit
Forward Voltage	V _F	I _F =1A, Pulse measurement	Max.0.58	V
Reverse Current	I _R	V _R =V _{RM} , Pulse measurement	Max.1	mA
Junction Capacitance	C _j	f=1MHz, V _R =10V	Typ.53	pF
Thermal Resistance	θ _{jl}	junction to lead	Max.10	°C/W
	θ _{ja}	junction to ambient	Max.113	

D1NS6

Forward Voltage

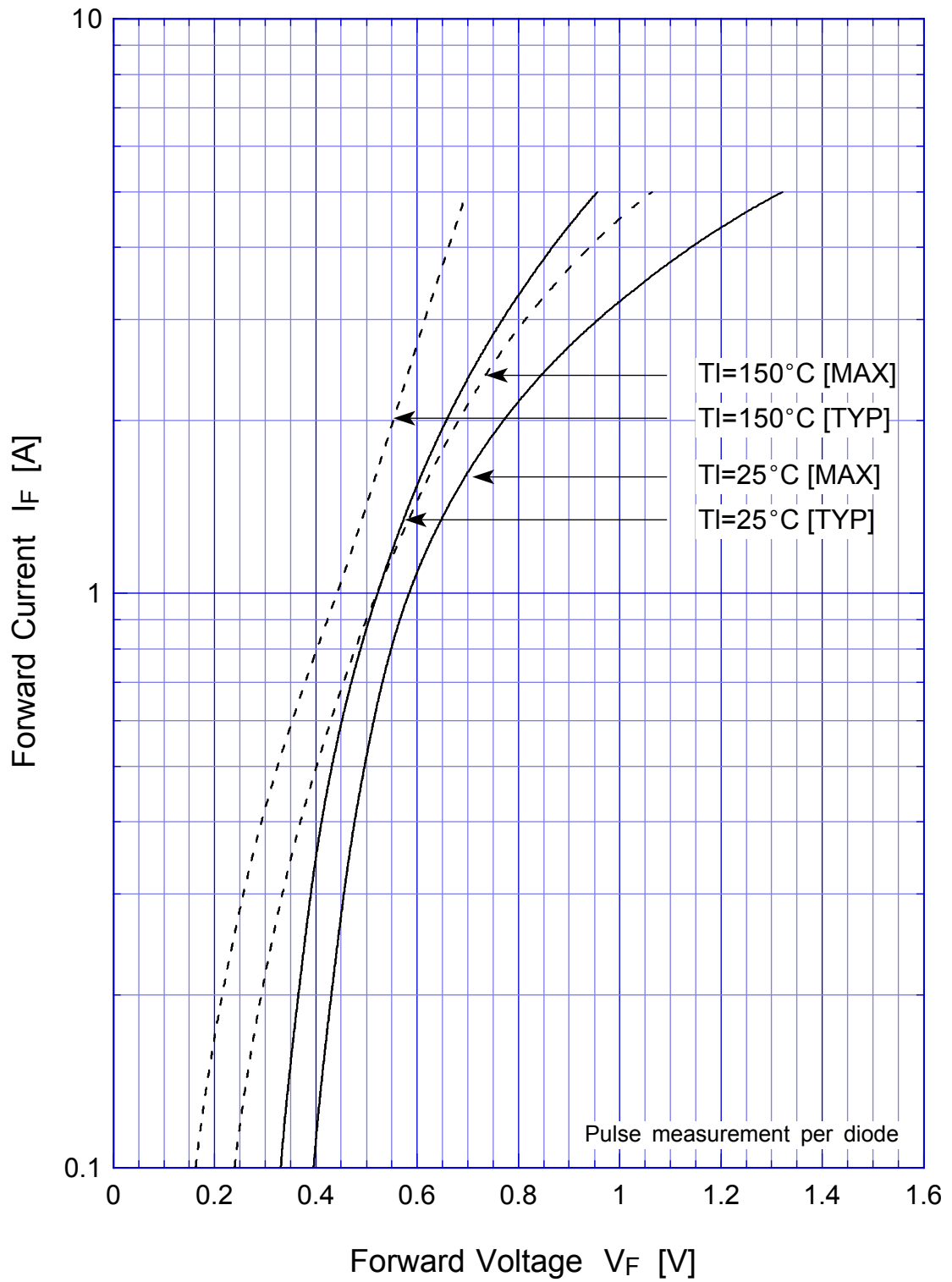

D1NS6

Junction Capacitance

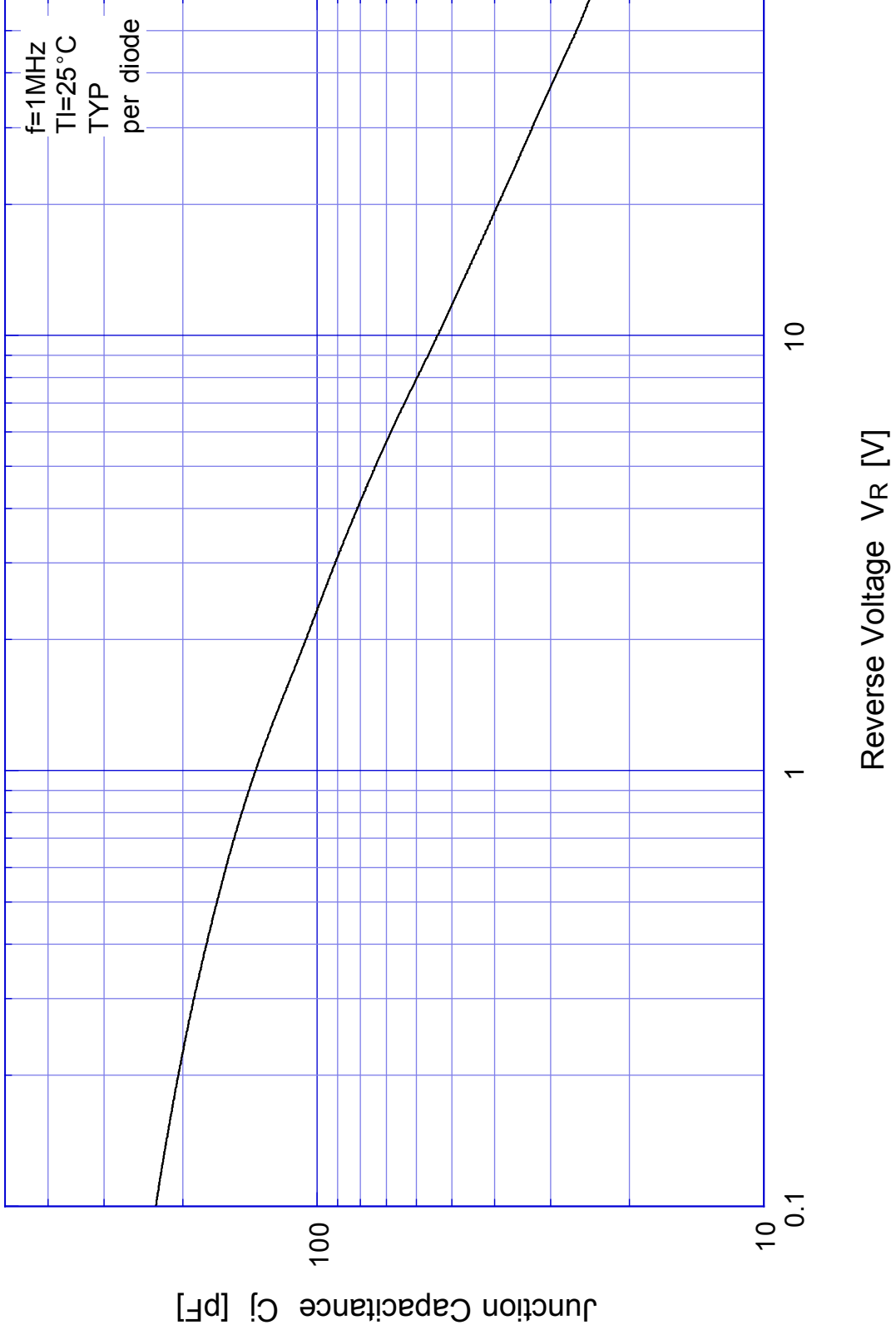

D1NS6

Reverse Current

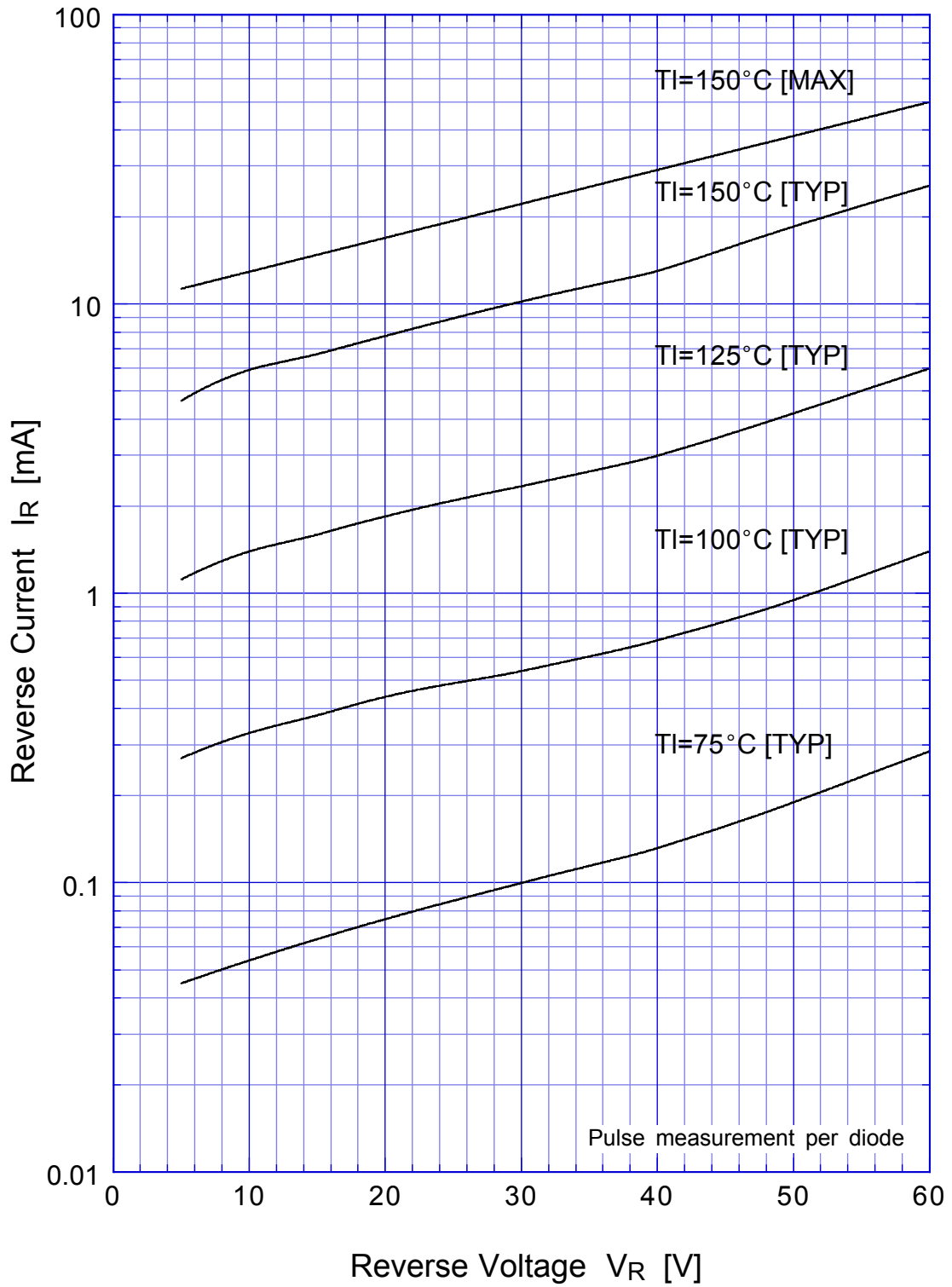

D1NS6

Reverse Power Dissipation

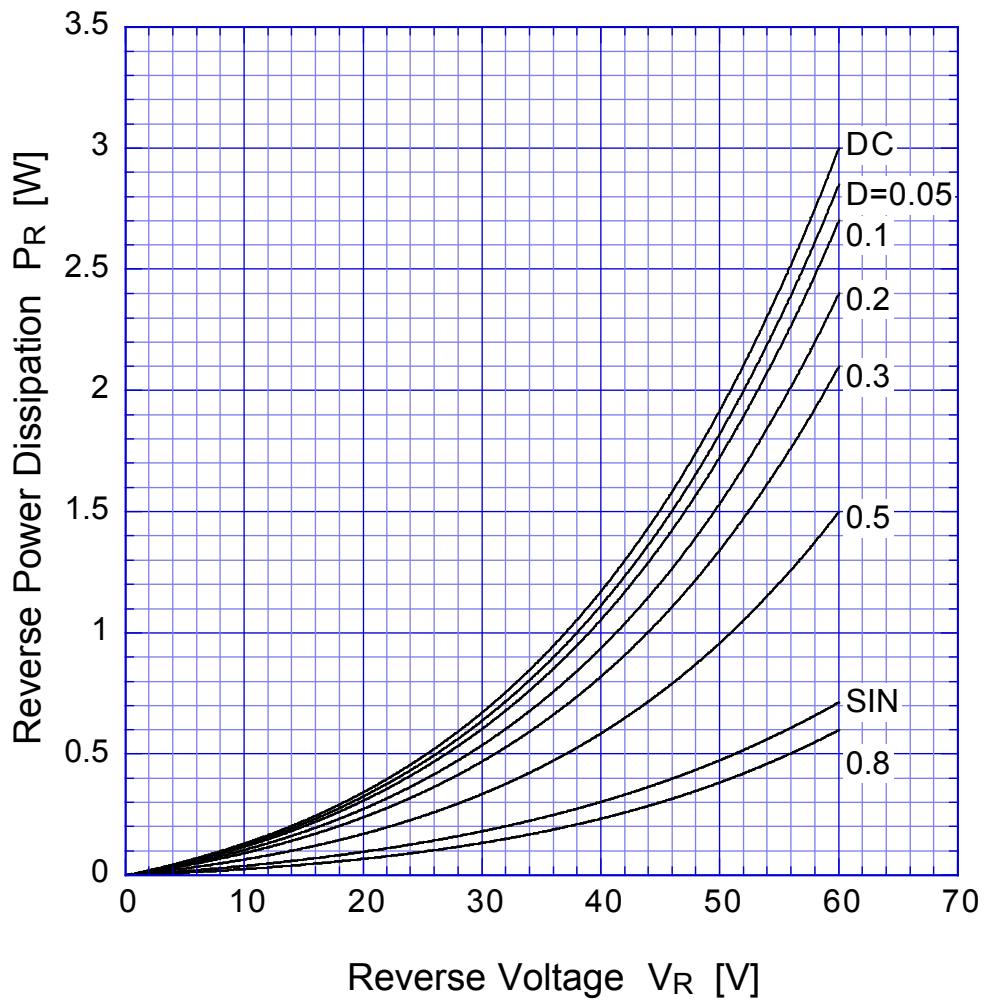

$T_j = 150^\circ\text{C}$

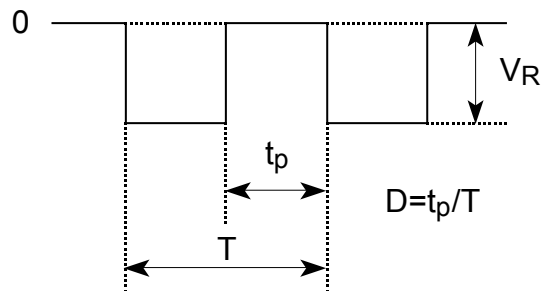

D1NS6

Forward Power Dissipation

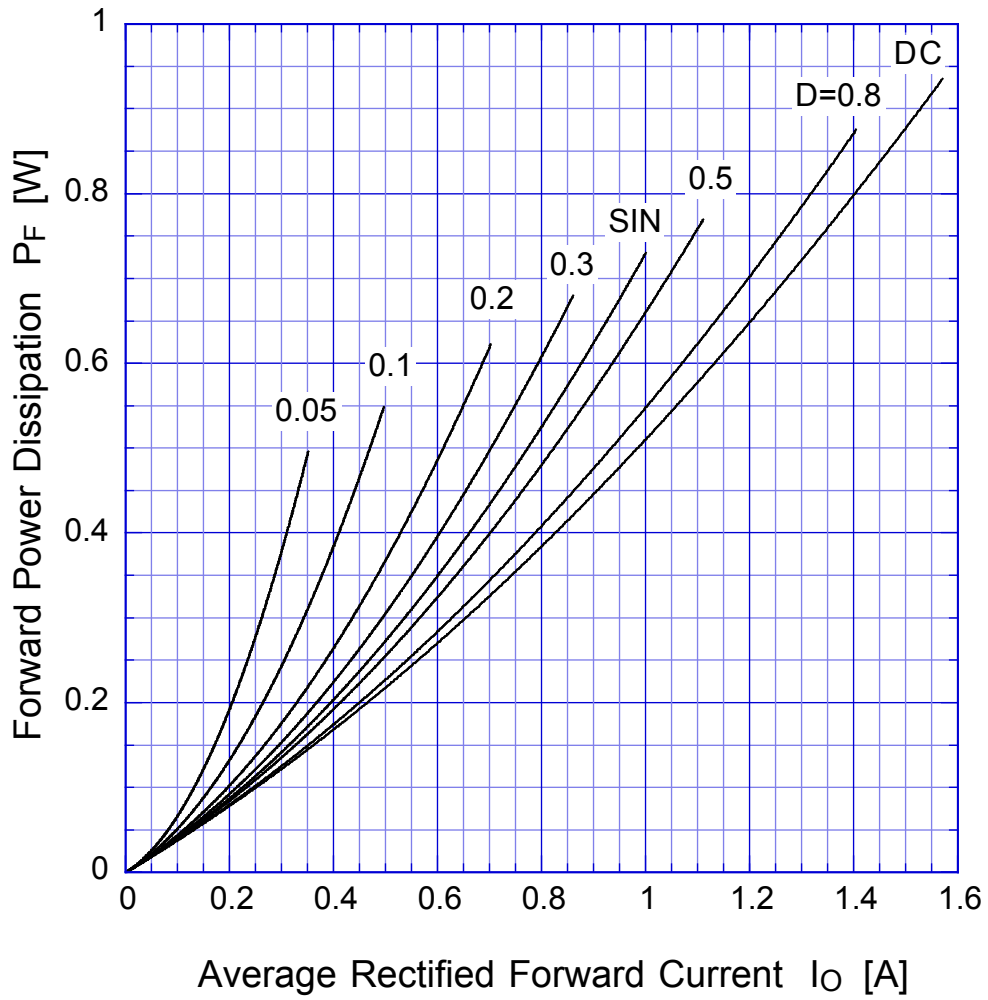

$T_j = 150^\circ\text{C}$

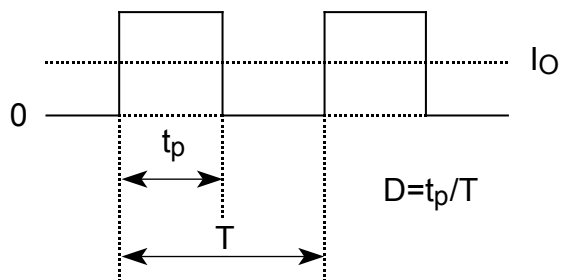

D1NS6

Derating Curve

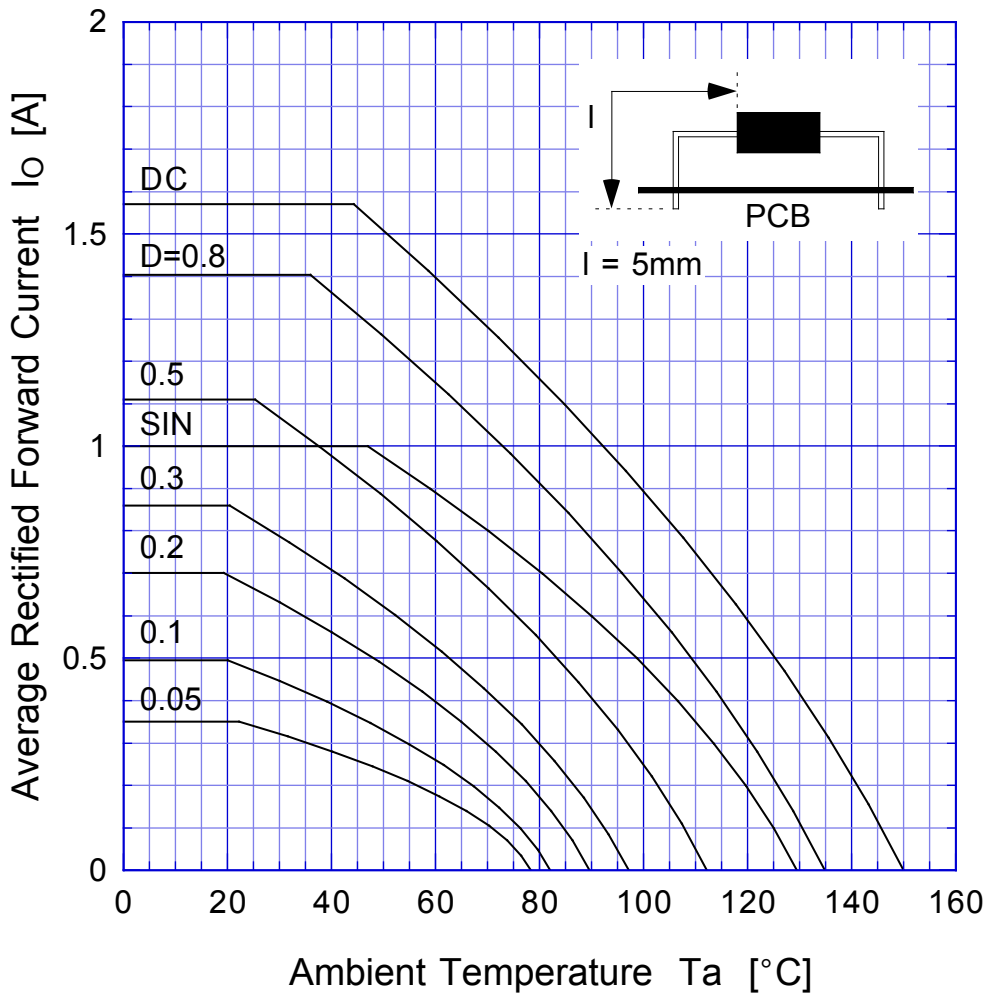

$V_R = 30\text{V}$



D1NS6

Peak Surge Forward Capability

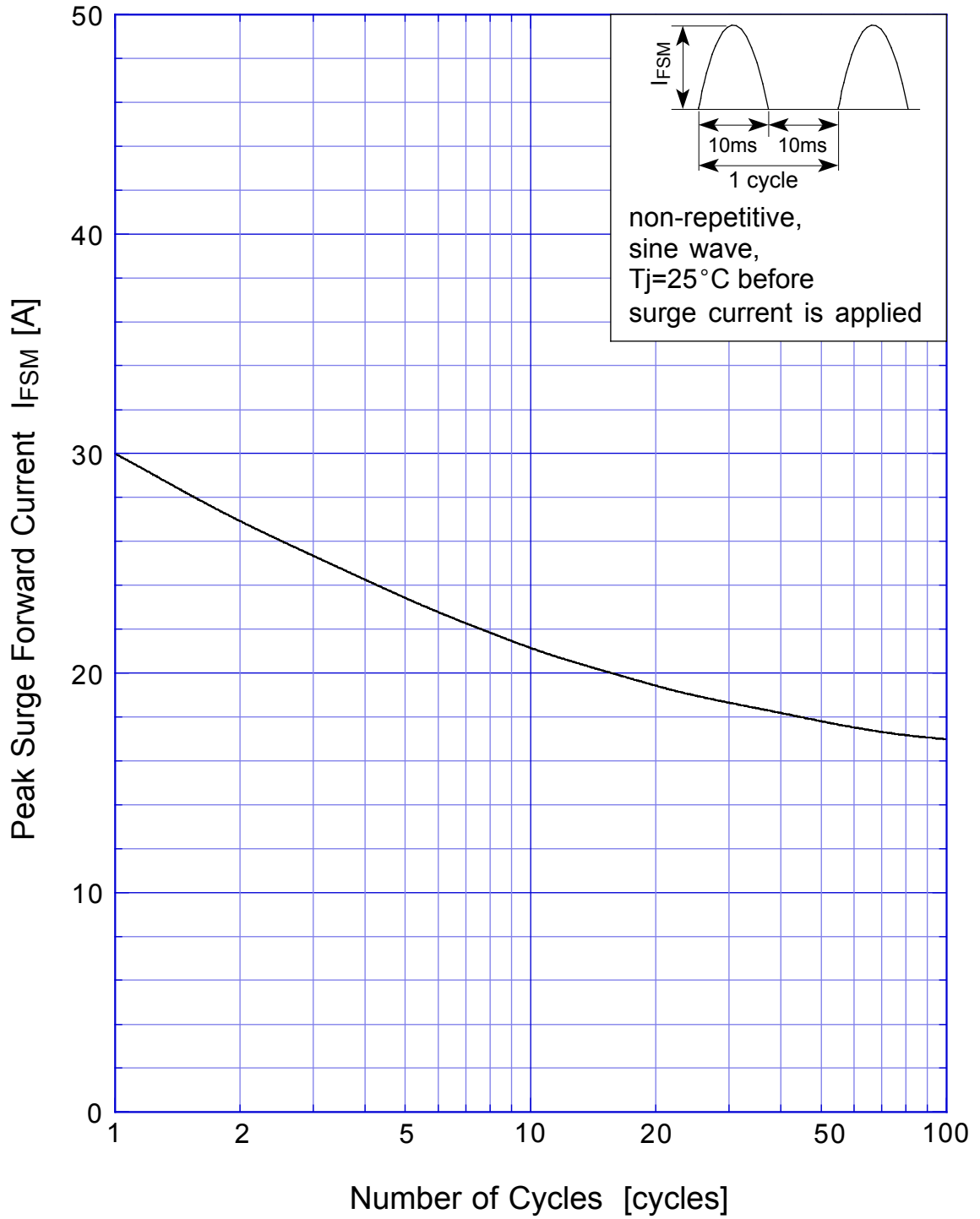

SBD Repetitive Surge Reverse Power Derating Curve



SBD

Repetitive Surge Reverse Power Capability

