

Thyristor Surge Suppressor

Version: A0 2014-02-24

Features

- Excellent capability of absorbing transient surge
- Quick response to surge voltage(nS Level)
- Eliminates overvoltage caused by fast rising transients
- Moisture sensitivity level: level 1
- Weight:87mg
- Non degenerative
- Bi-directional

Exterior

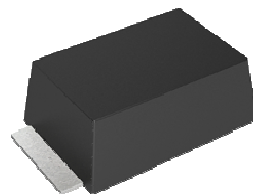

SMB-F

Application Information

- Ethernet

Package (Top View)



Agency Approvals

Icon	Description
RoHS	Compliance with 2011/65/EU
HF	Compliance with IEC61249-2-21:2003

Schematic Symbol



Part Number and Electrical Parameter

Part Number	I _{DRM} @V _{DRM} ^①		V _S ^② @ I _S		V _T @ I _T		I _H	C _o ^③
	μA	V	V	mA	V	A	mA	pF
	MAX		MAX		MAX		MAX	MAX
BS8000N-C-F	5	750	1000	800	4	2.2	50	50

Absolute maximum ratings measured at T_A= 25°C RH = 45%-75% (unless otherwise noted).

①Hi-pot:AC500V

②V_S is measured at 100KV/S.

③Off-state Capacitance is measured at V_{DC}=2V,V_{RMS}=1V,f=1MHz.

Thyristor Surge Suppressor

Version: A0 2014-02-24

Part Numbering System

BS 8000 N C F
(1) (2) (3) (4) (5)

- (1)Bencent Semiconductor Surge Arrester
- (2)Off-state Voltage,e.g. : 8000=800×10⁰=800V
- (3) Package :SMB
- (4) Rating Surge Voltage: 6KV (10/700μs)
- (5) Flat feet

V-I Curve

Parameters	Definition
V _{DRM}	Peak Off-state Voltage
I _{DRM}	Off-state Current
V _S	Switching Voltage
I _S	Switching Current
I _H	Holding Current
V _T	On-state Voltage
I _T	On-state Current
C _o	Off-state Capacitance

Mark

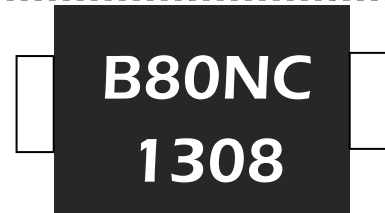

B80NC: Part Number
1308:August,2013

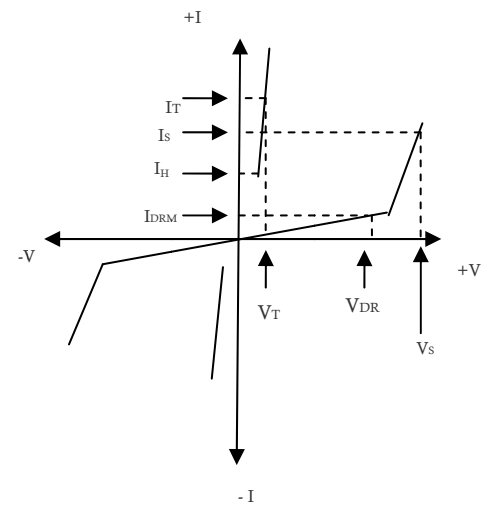

Surge Ratings

Current Waveform	8/20μs	5/320μs*	10/1000μs
Voltage Waveform	1.2/50μs	10/700μs*	10/1000μs
I _{pp}	400A	150A	100A

-Peak pulse current rating (I_{pp}) is repetitive and guaranteed for the life of the product;

-Bencent only makes the test for 5/320μs@150A* (10/700μs@6KV), but for other IPP value derived from experience is just for reference only. Bencent will not take any obligation for these parameters, so before applying our parts, please make sure to verify the parameters listed in the above table.

Thermal Considerations

symbol	Parameter	Value	Unit
T _J	Operating Junction Temperature Range	-40 to +150	°C
T _S	Storage Temperature Range	-60 to +150	°C

Physical Characteristics

Lead Material	Copper Alloy
Body Material	UL recognized epoxy meeting flammability classification 94V-0
Terminal Finish	100% Matte-Tin Plated

Typical Characteristics

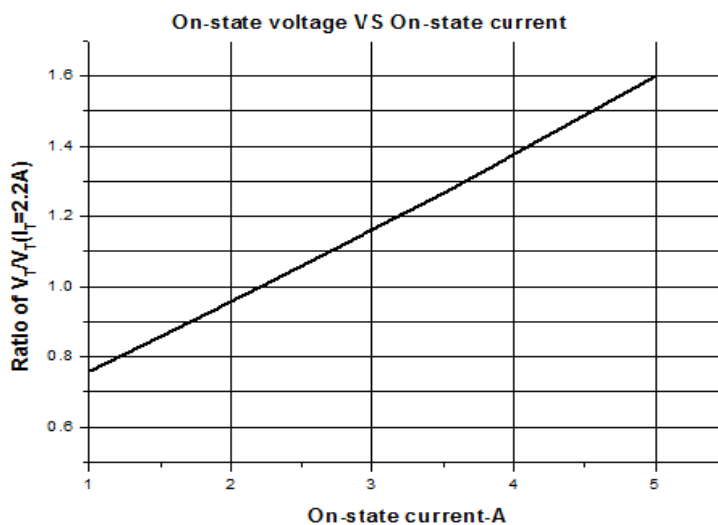
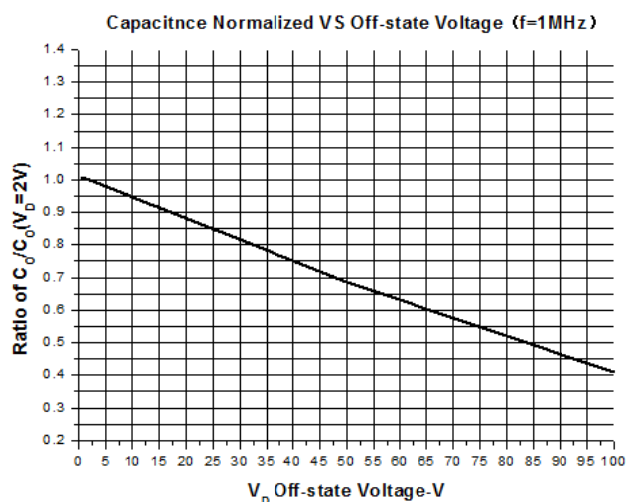
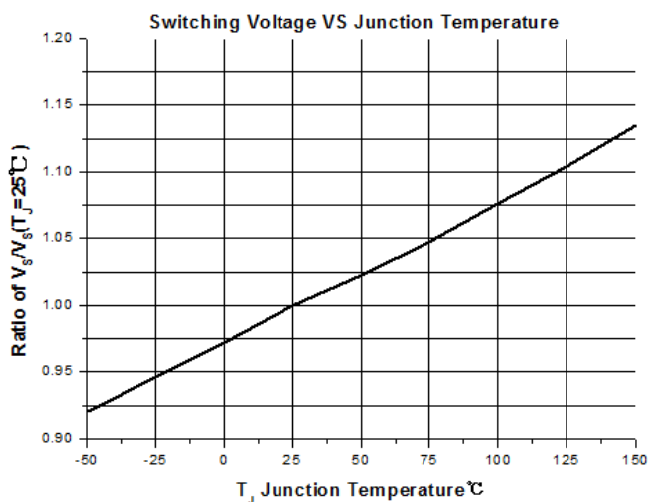
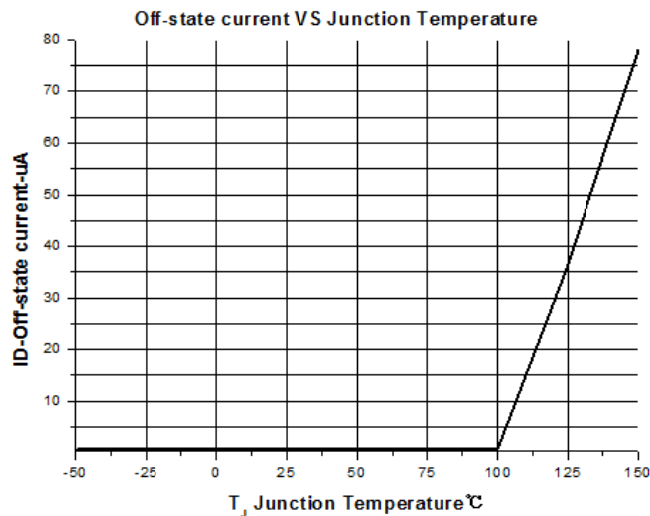
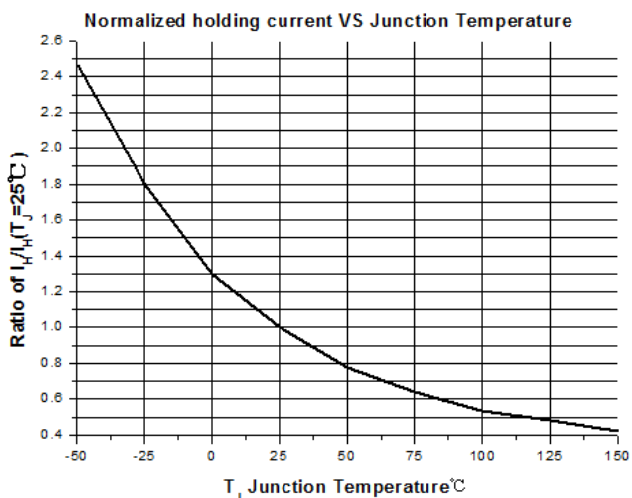

Thyristor Surge Suppressor

Version: A0 2014-02-24

Environmental Characteristics

Testing Items	Technical Standards
High Temperature Reverse Bias Test	Temperature: 150±3℃, Bias=80%V _{DRM} Time:168H
High Temperature Life Test	Temperature: 150℃ Time:168H
High-low Temperature Cycle Test	Temperature:From -40℃ to125℃ Dwell time: 30min, 10-100 cycles
High Temperature &High Humidity Test	Temperature: 85℃, Humidity:85% Test time:168H
Pressure Cooker Test	Temperature: 121℃, 2atm. Humidity:100% Test time:24H to 168H
Resistance of Soldering Heat	Temperature: 260±5℃ Time of dip soldering: 10s, 3times

Note: The above testing items can be specified by customers by contacting Bencent service

Product Dimensions

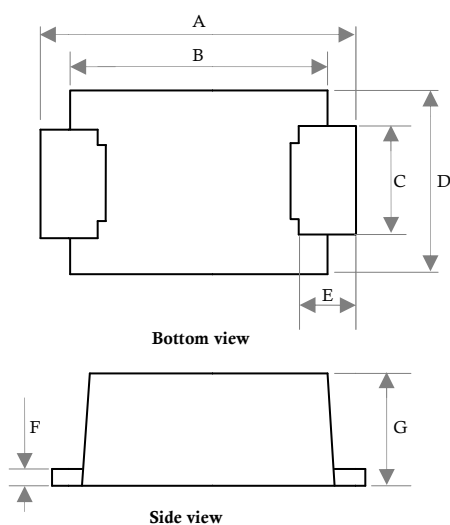

REF	mm	inch
A	5.4±0.3	0.213±0.012
B	4.4±0.2	0.173±0.008
C	2.0±0.1	0.079±0.004
D	3.3±0.3	0.130±0.012
E	0.8±0.3	0.032±0.012
F	0.25±0.05	0.010±0.002
G	2±0.3	0.079±0.012

Recommended Soldering Pad

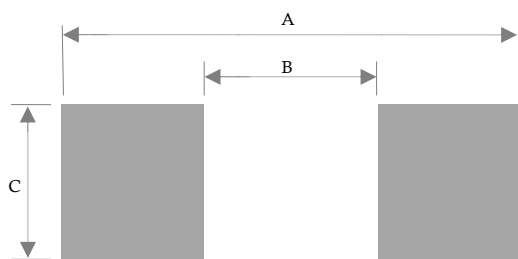

REF	mm	inch
A	6.4	0.252
B	3.4	0.134
C	2.75	0.108

Thyristor Surge Suppressor

Version: A0 2014-02-24

Reflow Profile

Reflow Condition		Pb-Free Assembly
Pre Heat	Temperature Min.	+150°C
	Temperature Max.	+200°C
	Time(Min to Max)	60 – 180 secs.
Average ramp up rate(LiquidusTemp(T_L) to peak)		3°C/sec.Max.
Ts(max) to T_L - Ramp-up Rate		3°C/sec.Max.
Reflow	- Temperature (T_L) (Liquidus)	+217°C
	- Temperature (T_L)	60 – 150 secs.
Peak Temp (T_P)		+(260+0/-5)°C
Time within 5°C of actual Peak Temp (T_P)		8 – 15secs.
Ramp-down Rate		6°C/sec.Max.
Time 25°C to peak Temp (T_P)		8 min. Max.
Do not exceed		+260°C

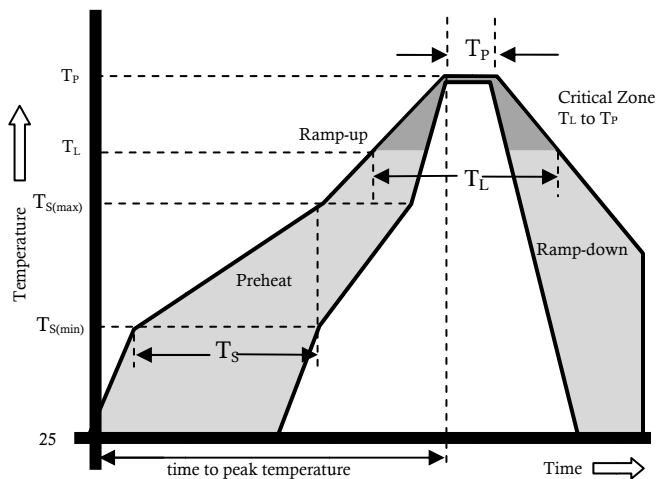

Package Reel Information

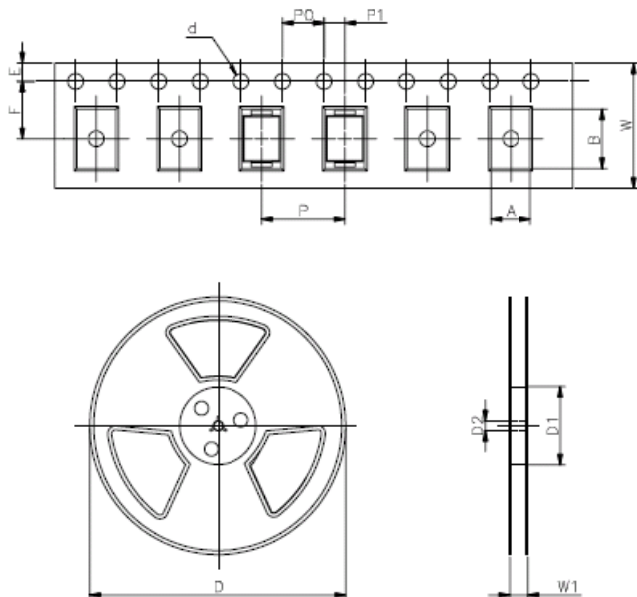

REF	mm	inch
A	3.65+/-0.3	0.144+/-0.012
B	5.69+/-0.3	0.244+/-0.012
d	1.5+/-0.1	0.059+/-0.004
D	330.0	13.0
D1	100+/-3	3.937+/-0.118
D2	13+/-0.3	0.512+/-0.012
E	1.5+/-0.2	0.059+/-0.008
F	5.65+/-0.2	0.222+/-0.008
P	8.0+/-0.2	0.315+/-0.008
P0	4.0+/-0.2	0.157+/-0.008
P1	2.0+/-0.2	0.079+/-0.008
W	12.0+/-0.2	0.472+/-0.008
W1	16.8+/-2.0	0.661+/-0.079

Outline	Reel (pcs)	Per Carton (pcs)	Reel Diameters (mm)	Carton Size(mm)		
				L	W	H
Taping	3,000	24,000	330	360	360	380