

MD4028 series

HIGH PERFORMANCE

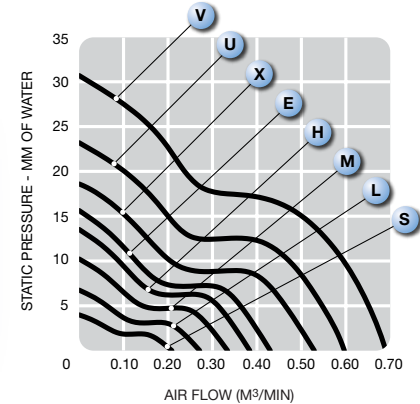
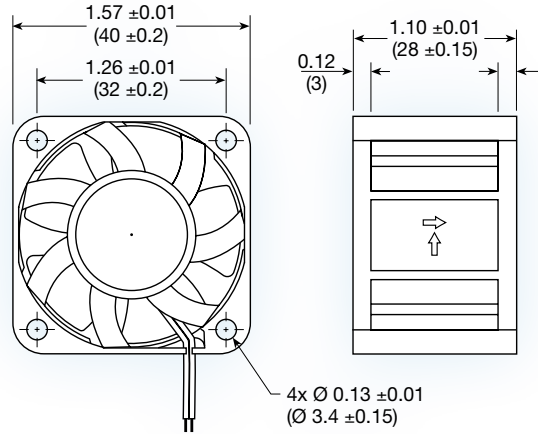

(40 x 40 x 28 mm)
1.57 x 1.57 x 1.10 inches

Construction: UL94V-0 PBT impeller & frame

Bearing option: ball bearing

Connection: AWG 26, UL1007 lead wires

Frame: ribbed

Protection: thermal

Options: tachometer output or locked rotor alarm signal; PWM speed control

Model No.	Rated Voltage V	Current mA		Speed RPM	Air Volume		Max. Static Pressure (H ₂ O)		Sound Noise dB(A)	Weight g
		12	24		M ³ /Min.	CFM	MM	INCH		
MD4028S	12/24	70	50	5,000	0.209	7.38	4.05	0.159	30.8	50
MD4028L	12/24	100	70	6,500	0.272	9.59	6.75	0.266	33.2	50
MD4028M	12/24	140	90	8,000	0.335	11.82	10.23	0.403	37.2	50
MD4028H	12/24	210	120	9,200	0.384	13.57	13.53	0.533	41.0	50
MD4028E	12/24	240	140	10,300	0.430	15.19	16.96	0.670	44.0	50
MD4028X	12/24	350	200	11,500	0.529	18.67	17.72	0.709	47.3	50
MD4028U	12	520	-	13,000	0.598	21.11	22.64	0.906	50.0	50
MD4028V	12	650	-	15,000	0.690	24.35	30.14	1.206	53.1	50