

Silicon PNP Power Transistors

2SB1274

DESCRIPTION

- With TO-220F package
- Complement to type 2SD1913
- High reliability.
- High breakdown voltage
- Low saturation voltage.
- Wide area of safe operation

APPLICATIONS

- 60V/3A low-frequency power amplifier
- General power amplifier applications

PINNING

PIN	DESCRIPTION
1	Emitter
2	Collector
3	Base

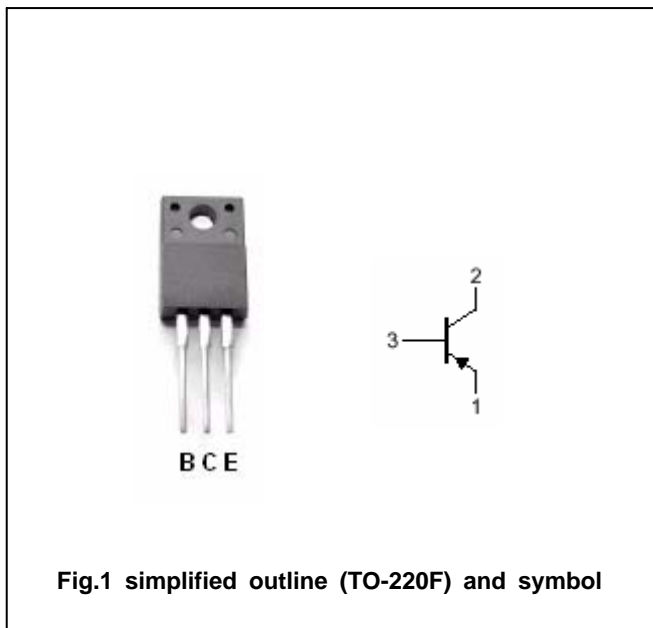

Absolute maximum ratings (Ta=25)

SYMBOL	PARAMETER	CONDITIONS	VALUE	UNIT
V_{CBO}	Collector-base voltage	Open emitter	-60	V
V_{CEO}	Collector-emitter voltage	Open base	-60	V
V_{EBO}	Emitter-base voltage	Open collector	-6	V
I_C	Collector current		-3	A
I_{CM}	Collector current-peak		-8	A
P_C	Collector dissipation	$T_C=25$	20	W
			2	
T_j	Junction temperature		150	
T_{stg}	Storage temperature		-55~150	

Silicon PNP Power Transistors

2SB1274

CHARACTERISTICS

T_j=25 unless otherwise specified

SYMBOL	PARAMETER	CONDITIONS	MIN	TYP.	MAX	UNIT
V _{(BR)CBO}	Collector-base breakdown voltage	I _C =-1mA; I _E =0	-60			V
V _{(BR)CEO}	Collector-emitter breakdown voltage	I _C =-5mA; R _{BE} =	-60			V
V _{(BR)EBO}	Base-emitter breakdown voltage	I _E =-1mA; I _C =0	-6			V
V _{CEsat}	Collector-emitter saturation voltage	I _C =-2A; I _B =-0.2A		-0.4	-1.0	V
V _{BE}	Base-emitter voltage	I _C =-0.5A; V _{CE} =-5V		-0.8	-1.0	V
I _{CBO}	Collector cut-off current	V _{CB} =-40V; I _E =0			-0.1	mA
I _{EBO}	Emitter cut-off current	V _{EB} =-4V; I _C =0			-0.1	mA
h _{FE-1}	DC current gain	I _C =-0.5A; V _{CE} =-5V	70		280	
h _{FE-2}	DC current gain	I _C =-3A; V _{CE} =-5V	20			
f _T	Transition frequency	I _C =-0.5A; V _{CE} =-5V		100		MHz
C _{OB}	Output capacitance	I _E =0; V _{CB} =-10V; f=1MHz		60		pF

◆ h_{FE-1} classifications

Q	R	S
70-140	100-200	140-280

Silicon PNP Power Transistors

2SB1274

PACKAGE OUTLINE

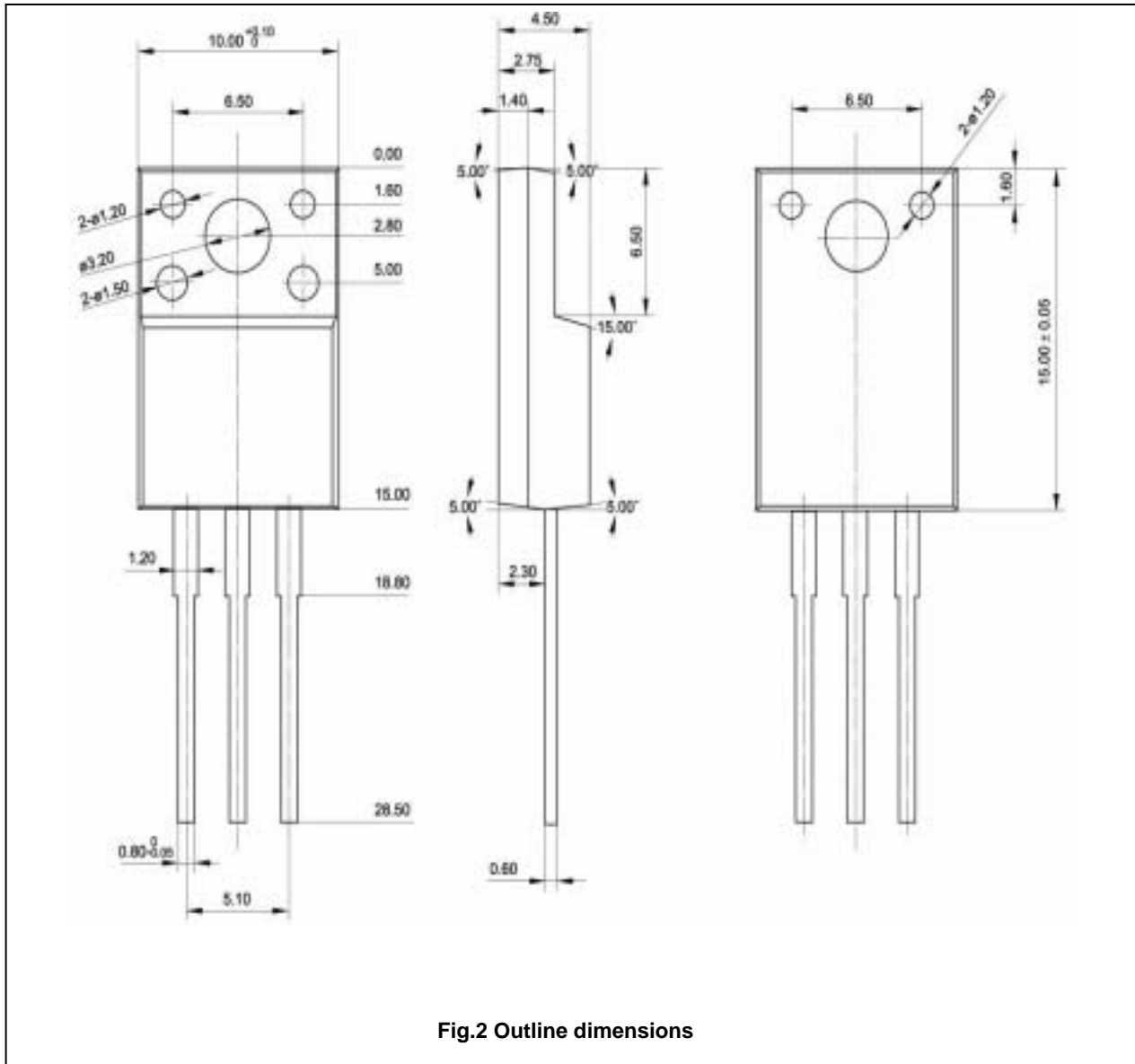

Fig.2 Outline dimensions

Silicon PNP Power Transistors

2SB1274

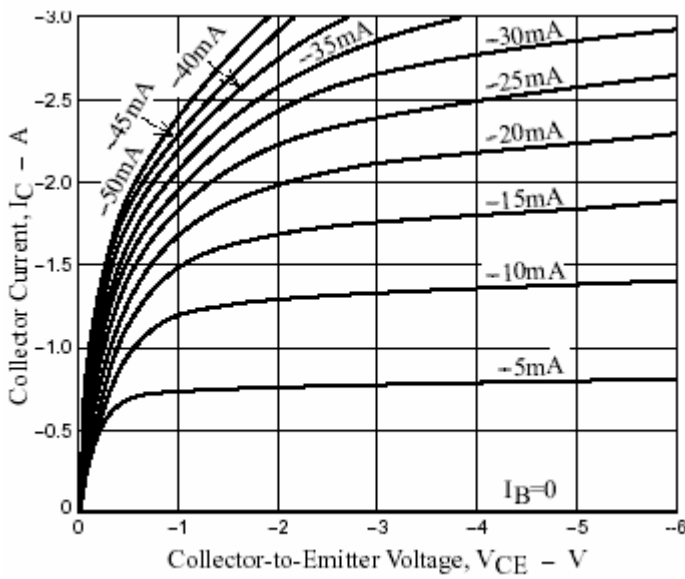

Fig.3 Static Characteristic

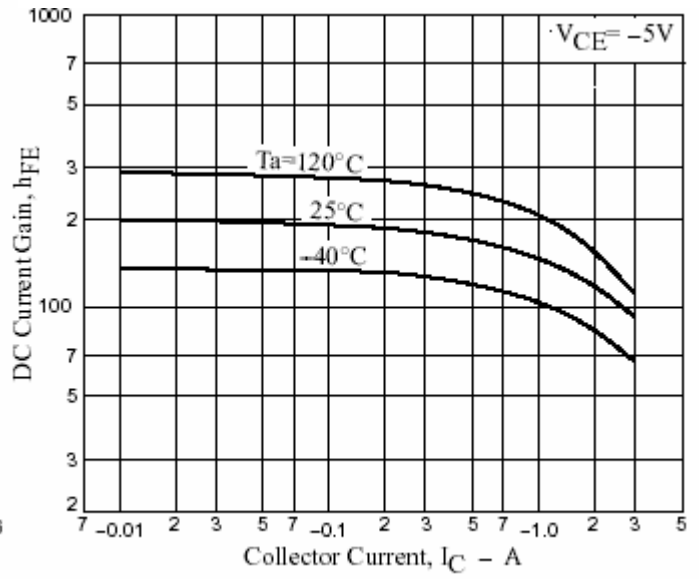

Fig.4 DC current Gain

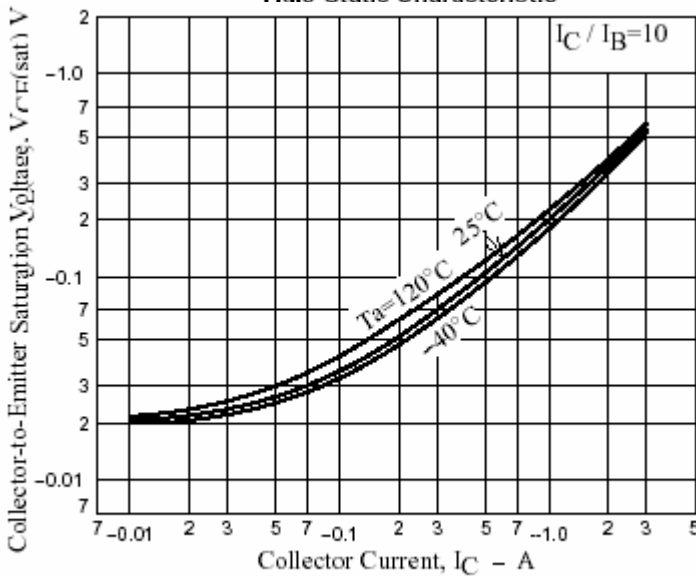

Fig.5 Collector-Emitter Saturation Voltage

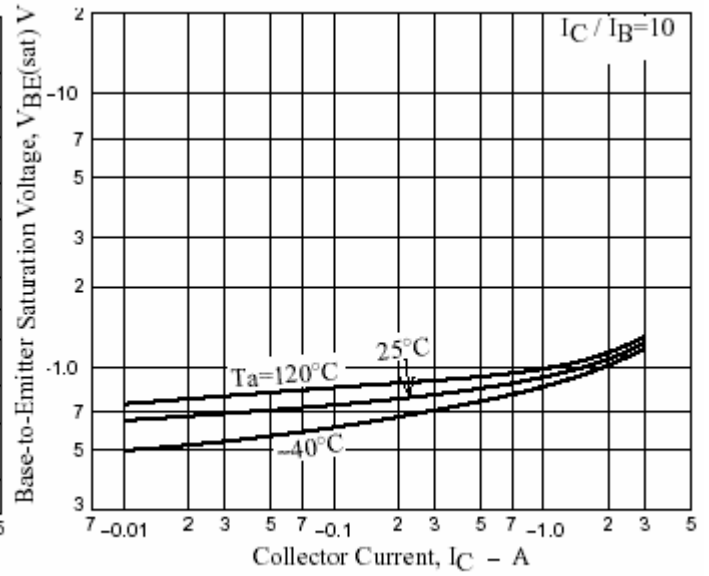

Fig.6 Base-Emitter Saturation Voltage

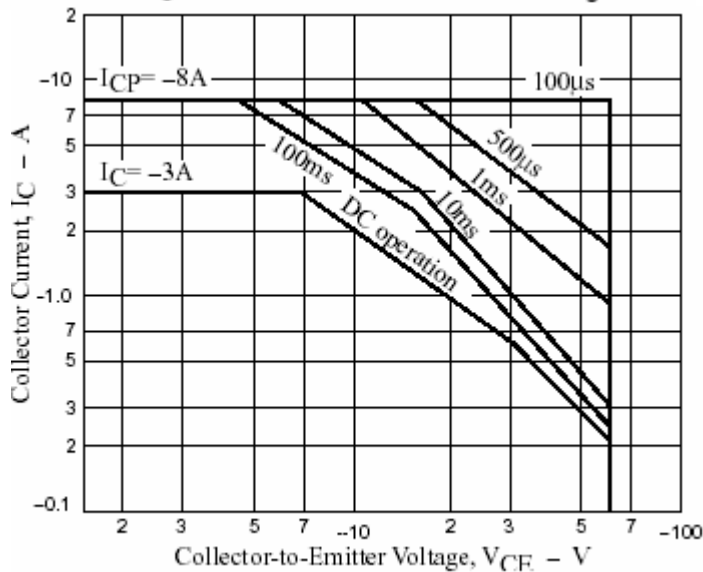

Fig.7 Safe Operating Area