

ELM901FxA 1A 2x Charge Pump LED Driver

■General description

ELM901FxA is a high current LED driver with internal automatic mode switch pump circuit of pass-through mode (1x mode) and boost charge mode (2x mode) and constant current drive circuit; maximum output current of ELM901 series can reach 1A. ELM901 series is ideally suited for high luminosity white LED electrical applications which are powered by 1-cell lithium-ion/polymer battery. The required external parts of ELM901 series can be limited to the minimum of 3 capacitors and 3 programming resistors. With 4mm x 4mm & 3mm x 3mm QFN package, ELM901 series is possible to be assembled within limited space.

The sink current, which can be switched to 3 different kinds by enable signal during operation, of LED pin is set by external programming resistors. For LED protection, it is possible to set high current lighting timer with external resistor; the light will be turned off forcibly by timer (3 options among 0.2 sec. to 1 sec.).

Built-in soft-start circuitry makes ELM901 series be able to limit excessive power during start-up and switch of 1x & 2x mode.

■Features

- Low voltage operation : 2.6V-4.4V
- Low power operation : 300 μ A(1x), 9mA(2x)
- Low standby current : Max.1 μ A
- Large output current : Max.1A
- LED protection : high current lightening timer
- Internal LED constant current circuit : external resistance program
- Soft-start : LED current start and switch of 1x & 2x mode
- Package : QFN16-4x4,
QFN16-3x3(under development)
- Thermal shutdown function included

■Application

- Camera light supply
- High luminosity LED flashlight

■Maximum absolute ratings

Parameter	Symbol	Limit	Unit
VIN voltage	Vin	GND-0.3 to 6	V
VO voltage	Vo	GND-0.3 to 6	V
EN1,EN2 voltage	Ven	GND-0.3 to Vin+0.3	V
VO current, LED current	Io, Iled	1500 *	mA
Operating temperature	Top	-40 to +85	°C
Storage temperature	Tstg	-40 to +125	°C

* Based on long-term current density limitations. Assumes an operating duty cycle of $\leq 10\%$ under absolute maximum conditions for durations less than 10 seconds. Max current for continuous operation is 600mA.

■Selection Guide

ELM901FxA-S

Symbol		
a	Package	F: QFN
b	Package type	A: QFN16-4x4 B: QFN16-3x3(under development)
c	Product version	A
d	Taping direction	S: Refer to PKG file

ELM901 F x A - S
 $\uparrow \uparrow \uparrow \uparrow$
 a b c d

ELM901FxA 1A 2x Charge Pump LED Driver

■ Pin Configuration

QFN16-4x4(TOP VIEW) QFN16-4x4(BOTTOM VIEW)

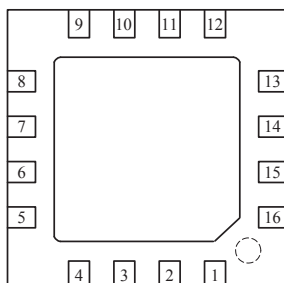
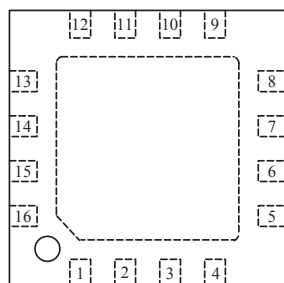

QFN16-3x3(TOP VIEW) QFN16-3x3(BOTTOM VIEW)

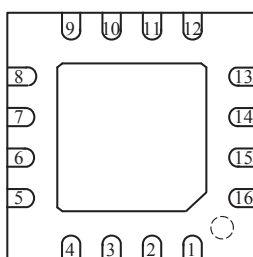
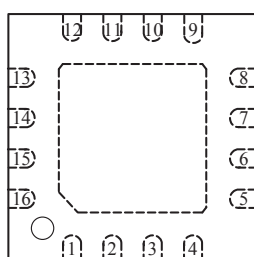

Pin no.	Pin name
1	ISET2
2	ISET1
3	EN2
4	EN1
5	AGND
6	FS
7	VIN
8	PGND1
9	CM
10	PVIN
11	CP
12	NC
13	VO
14	NC
15	PGND2
16	LED

■ Pin description

ISET2 : LED current setting 2

The pin that is for the connection of LED current setting resistor(R_{set2}) between ISET2-GND. The output becomes 1.22V constantly when EN2 is high. The constant current of LED pin will be 3250x of the one flows to ISET2.

(e.g.) when $R_{set2}=6.8k\Omega$, $I_{led}=1.22/6.8k \times 3250=583mA$.

ISET1 : LED current setting 1

The pin that is for the connection of LED current setting resistor(R_{set1}) between ISET1-GND. The output becomes 1.22V constantly when EN1 is high. The constant current of LED pin will be 3250x of the one flows to ISET1.

(e.g.) when $R_{set1}=20k\Omega$, $I_{led}=1.22/20k \times 3250=198.3mA$.

EN2 : on/off control 2

LED output current on/off control pin of set current of ISET2. This pin is pulled down to ground inside the IC and the control logic is high active. The set current of ISET2 sinks from LED pin when this pin is connected to VIN.

ELM901FxA 1A 2x Charge Pump LED Driver

EN1 : on/off control 1

LED output current on/off control pin of set current of ISET1. This pin is pulled down to ground inside the IC and the control logic is high active. The set current of ISET1 sinks from LED pin when this pin is connected to VIN.

AGND : internal analog circuit ground

This pin should be connected to GND of internal analog circuit and is connected in short circuit with internal circuit on back pad. The connection to PGND1 & PGND2 is required and should be designed according to the external wiring.

FS : fail safe setting

When EN1=EN2=1 continues for a period of time, fail safe function will turn down LED current forcibly. This function aims for thermal protection of LED, and it is possible to be turned off. There are 3 timer options according to the resistor connected between FS and GND since EN1=EN2=1 until LED current is off: (1)1s when the resistor is short, (2)0.2s when the resistor is 20k Ω , and (3)0.5s when the resistor is 51k Ω . This fail safe function becomes ineffective when it is short between FS and VIN or FS is open.

VIN : internal circuit power

This pin should be connected to the power pin of internal circuit. The connection to PVIN is required and should be designed according to the external wiring; GND-connected ceramic capacitor(above 2.2 μ F) is also necessary.

PGND1 : charge pump circuit ground

This pin should be connected to GND of charge pump circuit. The connection to AGND & PGND2 is required and should be designed according to the external wiring.

CM : step-up capacitor connection(low potential)

This pin should be connected to the low potential of step-up capacitor. The wiring of step-up capacitor should be connected between CM and CP as closely as possible; ELM recommends using 2.2 μ F capacitor.

PVIN : charge pump power

This pin is power supply of charge pump circuit. This pin should be connected to VIN according to the external wiring.

CP : step-up capacitor connection(high potential)

This pin should be connected to the high potential of step-up capacitor. The wiring of step-up capacitor should be connected between CM and CP as close as possible; ELM recommends using 2.2 μ F capacitor.

VO : step-up output

The output voltage is almost the same as VIN under 1x mode, while it becomes 5.5V under step-up mode. This pin should be connected to LED anode.

PGND2 : LED current drive circuit ground

This pin should be connected to the GND of LED current drive circuit. The connection to AGND & PGND1 is required and should be designed according to the external wiring.

LED : constant current sink

To sink the output current which is set by ISET1 & ISET2. This pin should be connected to LED cathode.

ELM901FxA 1A 2x Charge Pump LED Driver

■ Standard circuit

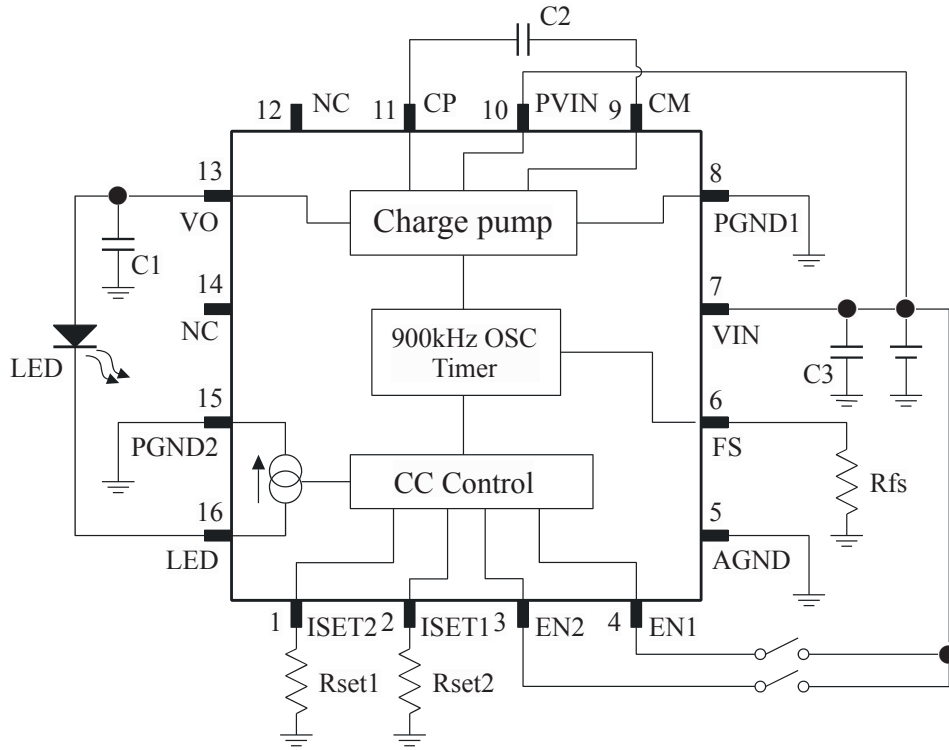

■ Block diagram

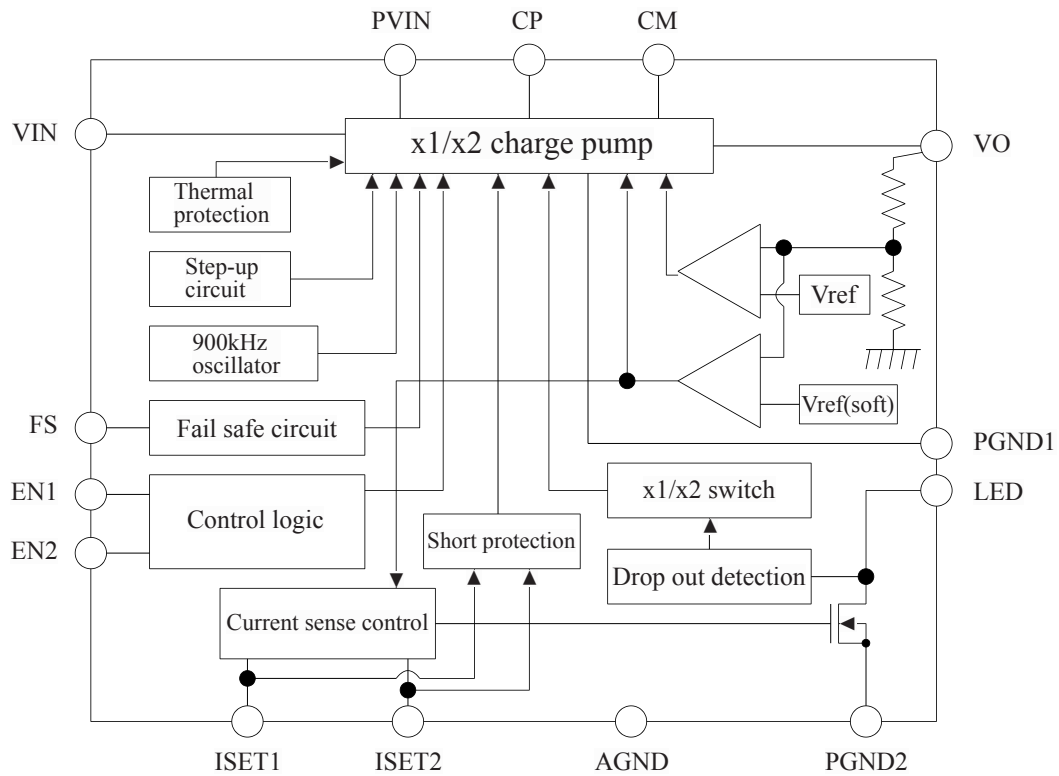

ELM901FxA 1A 2x Charge Pump LED Driver

■Operation

ELM901 is designed to drive high luminosity LED which is powered by 1 lithium-ion/polymer battery with constant current. When the battery voltage is much higher than LED forward voltage, LED is lit by connecting directly to the battery; output voltage is stepped up to 5.5V by internal charge pump circuit to light LED when voltage drops. LED current is driven by the constant current circuit which is set by external programming resistors. With 2 types of LED current programming resistors, 3 current-driving options can be designed by different combinations of enable circuit. ELM901A is capable of supplying output current up to 1A and thus able to provide high luminosity. To avoid LED burnout caused by longtime lighting by large current, the internal lighting timer of ELM901A can shut down current forcibly. The timer only operates when maximum setting current is on and can be set to 3 options-0.2s, 0.5s, 1s by external resistors connected to FS. This timer can be turned off when it is short between FS and VIN or FS is open.

Operation right after power is supplied

ELM901 becomes standby operation when EN1=EN2=0 or open(standby); unde this operation, high resistance PMOS switch between VIN and VO becomes ON. PMOS switch (=switch 4) between CP and VO and NMOS switch (=switch 1) between CM and PGND1 also become on. Hence, output capacitor Co and flying capacitor C1 are gradually charged through high resistance PMOS switch; it takes 5ms to full-charge after the power is on. Rush current may happen when operation starts within 5ms after power is on.

Standby mode

In this mode, output capacitor Co and flying capacitor become fully charged, and through individual high resistance PMOS switch, VIN is turned to be output mode. With maintenance of fully-charged mode during standby situation, it is possible to avoid rush current when operation begins and lighten LED rapidly.

Start-up mode

During start-up, ELM901 detects VO short first; the low resistance switch between VIN-VO becomes on and operates in 1x mode if short is not detected. When short is detected, Vo maintains the same condition as in standby mode, the output of LED also remains off while other internal circuits are operated normally. 1x mode is operated right after short is solved. It takes 30ms(typ.) from start-up to 1x mode output. Vo=Vin under normal operation, and inrush current does not occur due to the charge of capacitor. When abnormality (Vo>0.7V) such as short between VO and GND which is resulted from resistance of 10~1KΩ, inrush current occurs due to the charge of capacitor. LED current becomes ON after 130μs(typ.) after start-up; it takes less than 100us since LED current becomes ON until the set current flows.

1x mode

When dropout of LED pin is detected under 1x mode, the operation switches to 2x mode automatically. When LED current works under “low” current mode, the operation remains 1x mode for around 150ms even if the dropout of LED pin is detected; if dropout is dissolved during this period of time, timer is reset and 1x mode continues. When the operation is by “high” or “low+high” current, it becomes 2x mode after 2ms; if dropout is dissolved during this period of time, timer is reset and 1x mode continues. Dropout detection voltage is in proportion to Iled when it is above 240mA(typ.) and the voltage is regulated to 100mV when Iled is small.

ELM901FxA 1A 2x Charge Pump LED Driver

Soft step-up

The operation becomes soft step-up by charge pump operation right after 2x mode starts. Rush current is decreased by soft step-up which increases V_o straight. The current is controlled when I_{led} becomes 1/2 of the setting during soft step-up. I_{led} is limited under 350mA(typ.) forcibly to avoid abrupt change of I_{led} within 10 μ s after step-up operation starts. I_{led} control current returns to the setting after step-up is finished.

2x mode

After switching to normal 2x mode, operation remains this mode until standby mode(EN1=EN2=GND) starts. To work under 1x mode again, it is necessary to restart after switching to standby mode.

■Protection function

Thermal protection

When junction temperature becomes over 150°C, V_o output is turned to be OFF (only high resistance PMOS switch is ON)thermal shutdown circuit and LED output is shut down by thermal shutdown circuit. To shut down thermal protection, it is necessary to restart operation after returning to standby mode.

ISET1/ISET2 short protection

When EN1=0→1 during start-up, if Rset which is connected to ISET1 is under 3.9k Ω (setting current of I_{led} is above 1A),LED current which is the same with[low] current is shut down. If ISET2 is under normal operation under this situation, LED current which is the same with[high] current is flowed. When it is short between ISET1 and GND under the operation that EN1=1, LED current limit is detected by 1.5A and shut down without flowing to EN logic.

When EN2=0→1 during start-up, if Rset which is connected to ISET2 is under 3.9k Ω (setting current of I_{led} is above 1A), LED current which is the same with[high] current is shut down. If ISET1 is under normal operation under this situation, LED current which is the same with[low] current is flowed. When it is short between ISET2 and GND under the operation that EN2=1, LED current limit is detected by 1.5A and shut down without flowing to EN logic.

LED current becomes 0 when [low]+[high]current reaches 1.5A under EN1=EN2=1 under the above-mentioned 2 situations.

VO short protection

When V_o lowers to around 0.7V during operation, device shuts down the outputs of both V_o and LED; V_{in} and V_o become connected by high resistance PMOS switch(standby output) under this situation. After V_o short is dissolved and V_o rises above 0.7V, outputs of V_o and LED restart. When V_o short is detected under 2x mode, the operation switches to standby mode.

Fail safe function

Fail safe function refers to the function that the output of LED is turned to be OFF automatically when “low+high” current(EN1=EN2=1) continues for certain period of time. To dissolve the function that LED output is turned to be OFF forcibly, it is necessary to switch EN1=EN2=1 to other modes. 3 options are available for FS time; FS time is set by external resistors (Rfs). This function can be turned off by setting short between FS and VIN pins or FS to be open.

ELM901FxA 1A 2x Charge Pump LED Driver

■Electrical characteristics

When conditions are not mentioned specifically, $V_{in}=3.6V$, $C_{in}=C1=2.2\mu F$, $C_o=4.7\mu F$, $T_a=25^{\circ}C$

Parameter	Symbol	Condition	Min.	Typ.	Max.	Unit
Input voltage range	V_{in}		2.6		4.4	V
current consumption under still condition 1	I_{qs1}	1x mode, $I_{led}=0mA$		300	550	μA
current consumption under still condition 2	I_{qs2}	2x mode, $I_{led}=0mA$		9	16	mA
Standby current	I_{sd}	$EN1=EN2=0V$		0.1	1.0	μA
LED current						
LED current ratio1 ($I_{led}/I_{set1/2}$)	I_{led1}	$V_{in}=3.8V$, $I_{led}=200mA$, $V_f=3.3V$	typ.× 0.96	3250	typ.× 1.04	mA/mA
LED current ratio2 ($I_{led}/I_{set1/2}$)	I_{led2}	$V_{in}=3.3$ to $4.4V$, $I_{led}=200$ to $800mA$	typ.× 0.90	3250	typ.× 1.10	mA/mA
I_{led} dropout voltage1	V_{led1} (Min.)	Mode switch threshold voltage, $I_{led}=300mA$		125	225	mV
I_{led} dropout voltage2	V_{led2} (Min.)	Mode switch threshold voltage, $I_{led}=150mA$	80	100	120	mV
Mode switch delay time1	T_{d1}	$EN1=High$, $EN2=Low$	100	150	200	ms
Mode switch delay time2	T_{d2}	$EN1=Low$ or $High$, $EN2=High$	1	2	3	ms
LED current on time	LED(on)	since EN is ON until LED current starts	50	130	250	μs
Current capability	I_{led} (Max.)	$V_{in}=3.3V$, $EN1=EN2=High$, set $I_{led}=1A$, $V_F=4.6V$	900			mA
LED current stabilize time1	T_{Iled1}	$I_{led}=0mA \rightarrow 200mA$		40		μs
LED current stabilize time2	T_{Iled2}	$I_{led}=200mA \rightarrow 700mA$		60		μs
LED current during soft step-up	I_{led} (soft)	set $I_{led}=700mA$	250	350	450	mA
Charge pump						
Soft step-up	T_{soft}	$I_{led}=700mA$, $V_o=3.7V \rightarrow 5.2V$	75	150	300	μs
1x mode output voltage	$V_o(x1)$	$I_{led}=0mA$		V_{in}		V
2x mode output voltage	$V_o(x2)$	$I_{led}=0mA$	typ.× 0.95	5.5	typ.× 1.05	V
1x mode output impedance	$R_o(x1)$	$V_{in}=3.4V$		0.25	0.37	Ω
2x mode output impedance	$R_o(x2)$	$(2V_{in}-V_o)/I_o$, $V_{in}=3.2V$, $V_o=5.1V$		1.70	2.55	Ω
Oscillation frequency	F_{osc}		0.72	0.90	1.08	MHz
EN1, EN2						
Output on control voltage	$V_c(ON)$	$V_{in}=2.9$ to $4.4V$, each pin	0.95			V
Output off control voltage	$V_c(OFF)$	$V_{in}=2.9$ to $4.4V$, each pin			0.45	V
EN bias current	$I_c(ON)$	$V_{en}=3.6V$, each pin		20	50	μA
ISET1, ISET2						
Reference voltage	V_{ref}	$I_{set}=50\mu A$, each pin	1.202	1.220	1.238	V
ISET set current	I_{set}	each pin			310	μA

ELM901FxA 1A 2x Charge Pump LED Driver

Parameter	Symbol	Condition	Min.	Typ.	Max.	Unit
Short protection circuit						
Iled limit when ISET is short	Iled (short)	ISET1&2 turn Iled to be OFF for short protection, Vin=3.9V, Vled=1.0V, 2x operation		1.5		A
VO short protection detection voltage	Vo (short)	Iled is OFF when short protection is activated	0.45	0.60	0.95	V
VO short current	Ishort	Vin=3.6V		30		mA
Thermal protection circuit						
Thermal protection circuit	OHP	Iled is OFF when thermal protection circuit is activated		150		°C
Fail safe circuit						
Fail safe set range	Tfs (range)	* Fail safe function is OFF when FS-VIN is short or open.	0.2		1.0	s
Fail safe time1	Tfs1		0.80	1.00	1.20	s
Fail safe time2	Tfs2		0.16	0.20	0.24	s
Fail safe time3	Tfs3		0.40	0.50	0.60	s
Fail safe current	Ifs		10	15	20	μA
FS threshold voltage1	Vfs1		0.120	0.150	0.180	V
FS threshold voltage2	Vfs2		0.405	0.450	0.495	V
FS threshold voltage3	Vfs3		1.080	1.220	1.360	V

Parameter			Condition
EN logic & LED current			
EN logic	EN1	EN2	* EN1 & EN2 will be in standby mode when being pulled down to be open.
Standby(output OFF)	0	0	
Low current	1	0	
High current	0	1	
Low+High current	1	1	

■ Marking

• QFN16-4x4 package : ELM901FAA

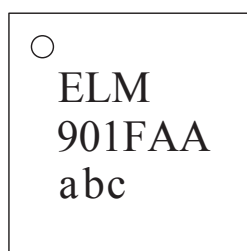

Mark	Content
ELM901FAA	Name
abc (000 to 999)	Assembly lot No.

• QFN16-3x3 package : ELM901FBA

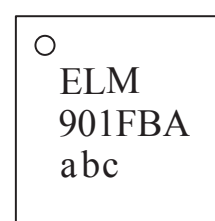

Mark	Content
ELM901FBA	Name
abc (000 to 999)	Assembly lot No.

ELM901FxA 1A 2x Charge Pump LED Driver

■ Typical characteristics

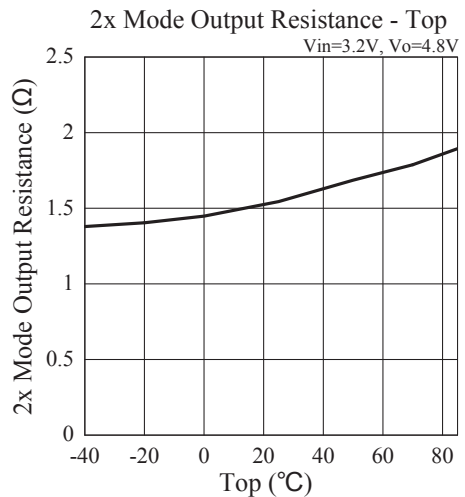
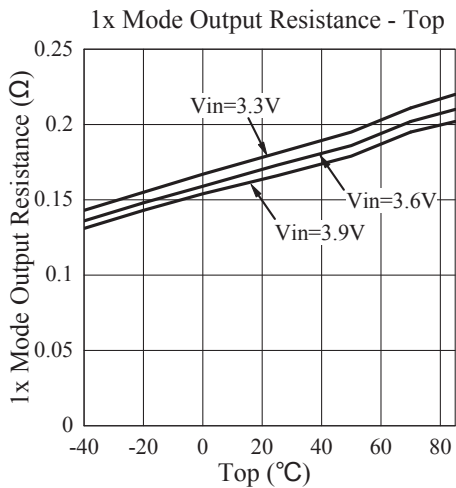
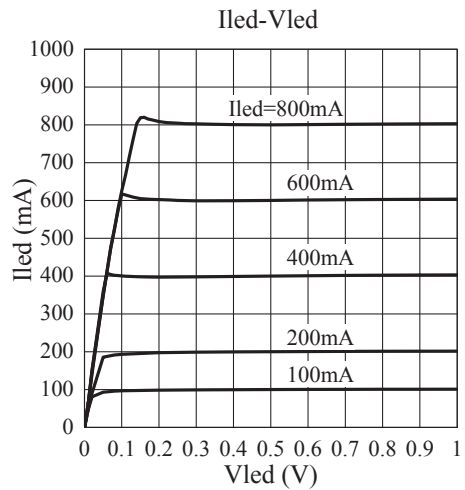
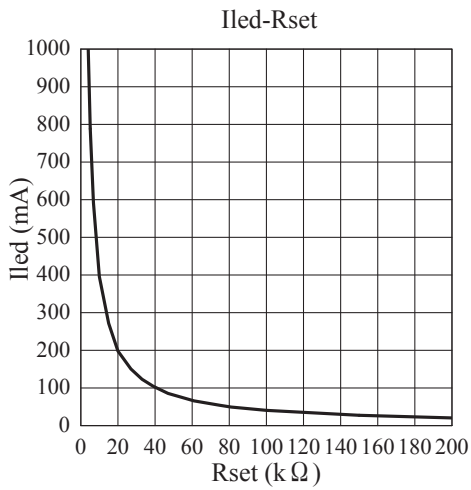
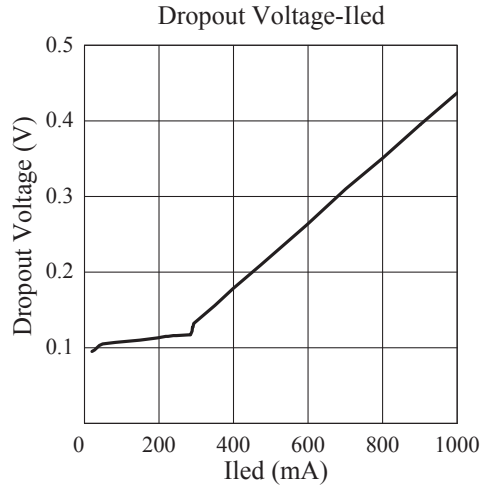
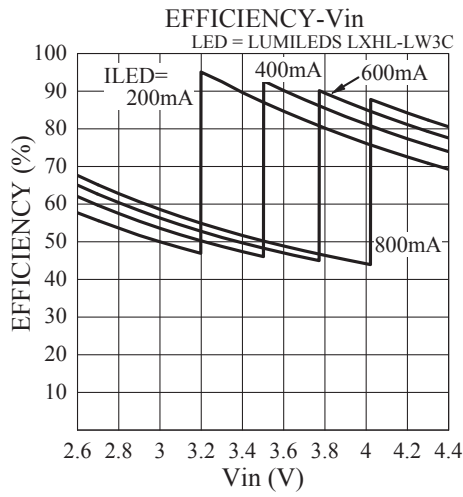

ELM901FxA 1A 2x Charge Pump LED Driver

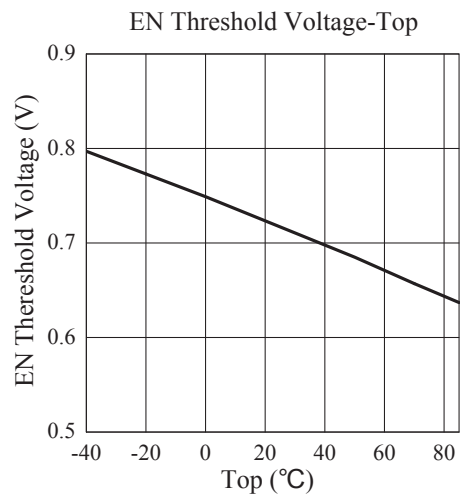
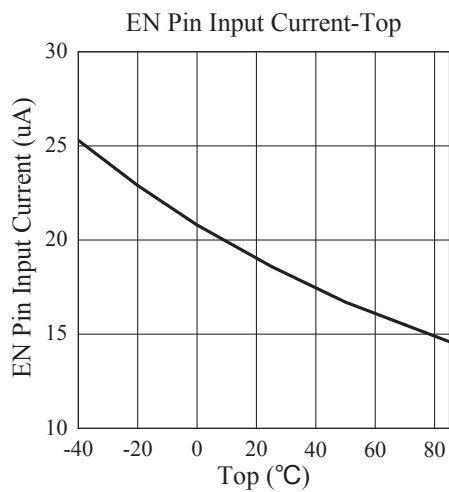
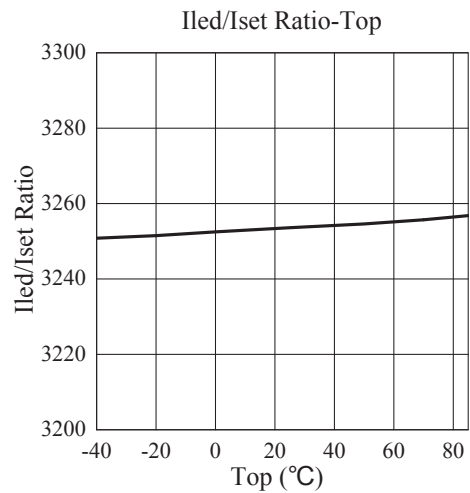
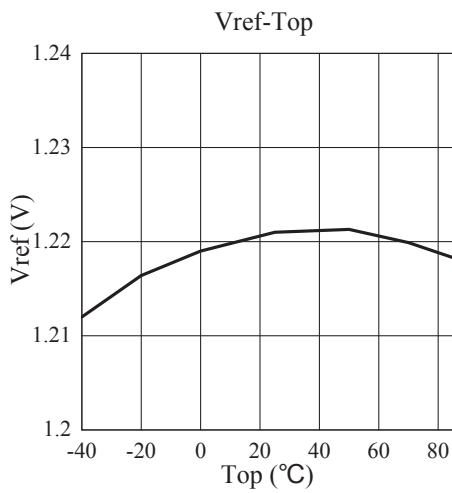
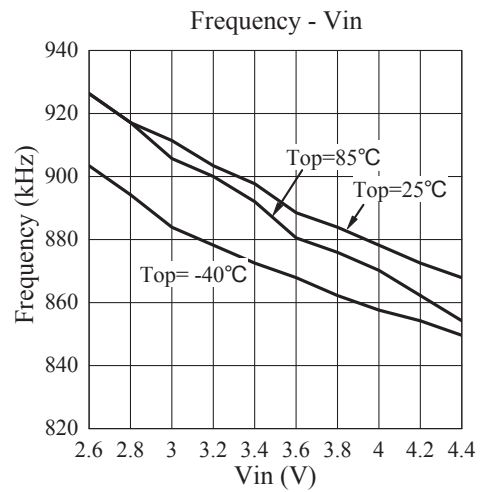
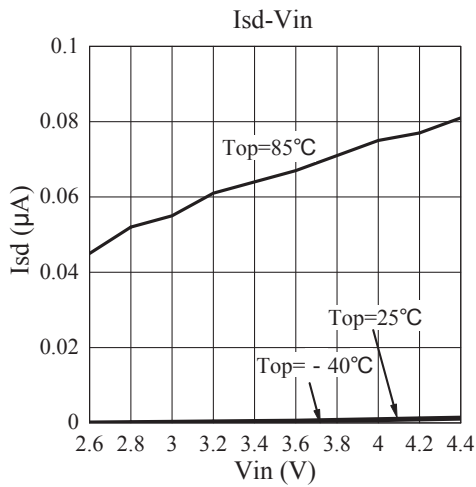

ELM901FxA 1A 2x Charge Pump LED Driver

