

XGA Flat Panel Controller

FEATURES

General

- Auto configuration of sampling clock frequency, phase, H/V center, as well as white balance.
- Auto detection of present or non-present or over range sync signals and their polarities.
- Composite sync separation and odd/even field detection of interlaced video.
- No external memory required.
- On-chip output PLL provide clock frequency fine-tune (inverse, duty cycle and delay).
- Serial 2-wire I²C host interface.
- 3.3V supplier, 5V I/O tolerance in 128-pin PQFP package.

Input Processor

- Single RGB (24-bit) input rates up to 100MHz.
- Support both non-interlaced and interlaced RGB graphic input signals.
- YUV 4:2:2 or YUV 4:1:1 (CCIR601/CCIR656) interlaced video input.
- Glue-free connection to Philips SAA711x digital video decoder.
- Built-in YUV to RGB color space converter.
- Compliant with digital LVDS/PanelLink TMDS input interface.
- PC input resolution up to XGA 1024x768 @85Hz.

Video Processor

- Independent programmable Horizontal and Vertical scaling up ratios from 1 to 32
- Flexible de-interlacing unit for digital YUV video input data.
- Zoom to full screen resolution of de-interlaced YUV video data stream.
- Built-in programmable gain control for white balance alignments.
- Built-in programmable 8-bit gamma correction table.
- Built-in programmable temporal color dithering.
- Built-in programmable interpolation look-up table.
- Support smooth panning under viewing window change.

Output Processor

- Single pixel (18/24-bit) or Dual pixel (36/48-bit) per clock digital RGB output.
- Built-in output timing generator with programmable clock and H/V sync.
- Support VGA/SVGA/XGA display resolution.
- Overlay input interface with external OSD controller.
- Double scan capability for interlaced input.

GENERAL DESCRIPTION

The MTL005 Flat Panel Display (FPD) Controller is a low-cost input format converter for TFT-LCD Monitor or LCD TV application which accepts 15-pin D-sub RGB graphic signals (through ADC), YUV signals from digital video decoder or digital RGB graphic signals from PanelLink TMDS receiver. It comprises a RGB/YUV input processor, video scaling up processor, OSD input interface and output display processor in 128-pin PQFP.

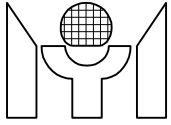

BLOCK DIAGRAM

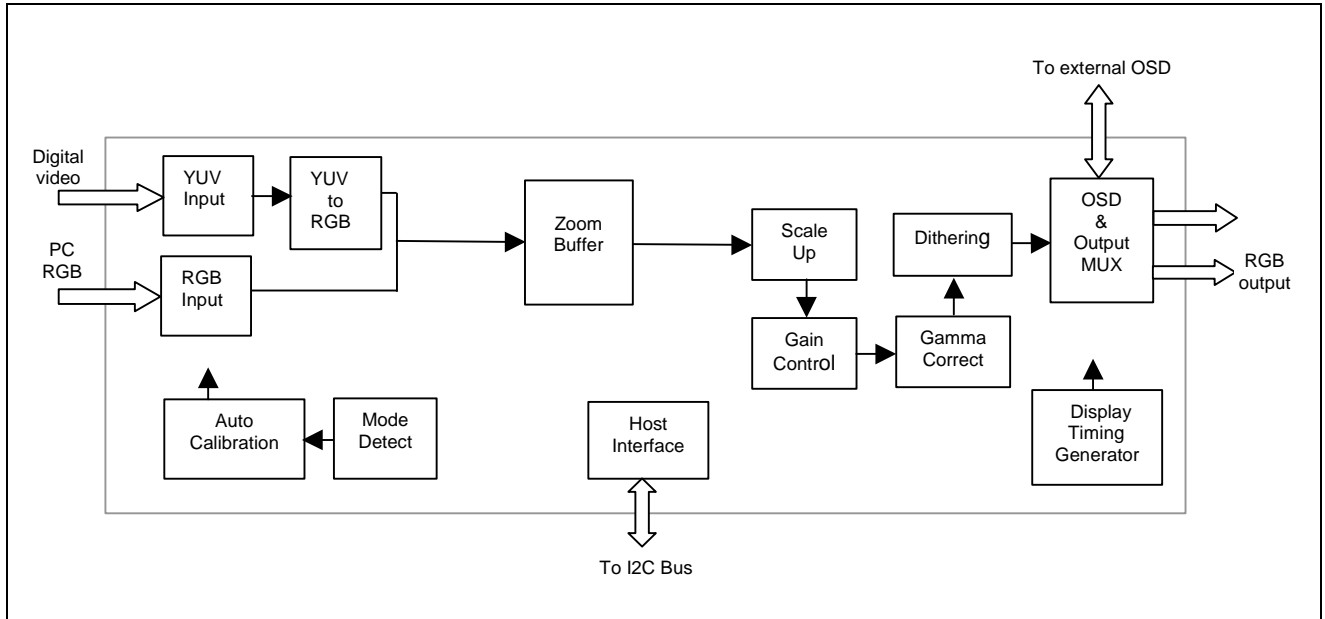

APPLICATIONS

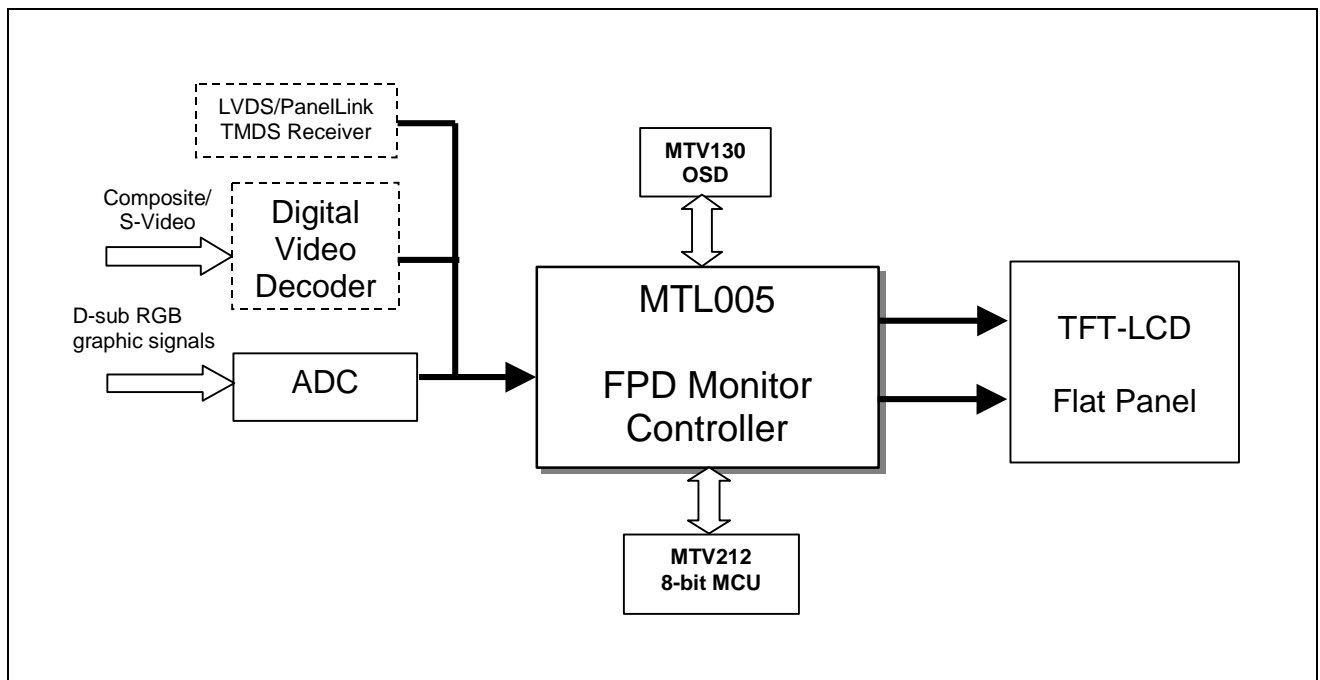

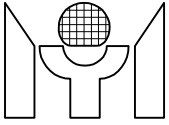

1. PIN CONNECTION

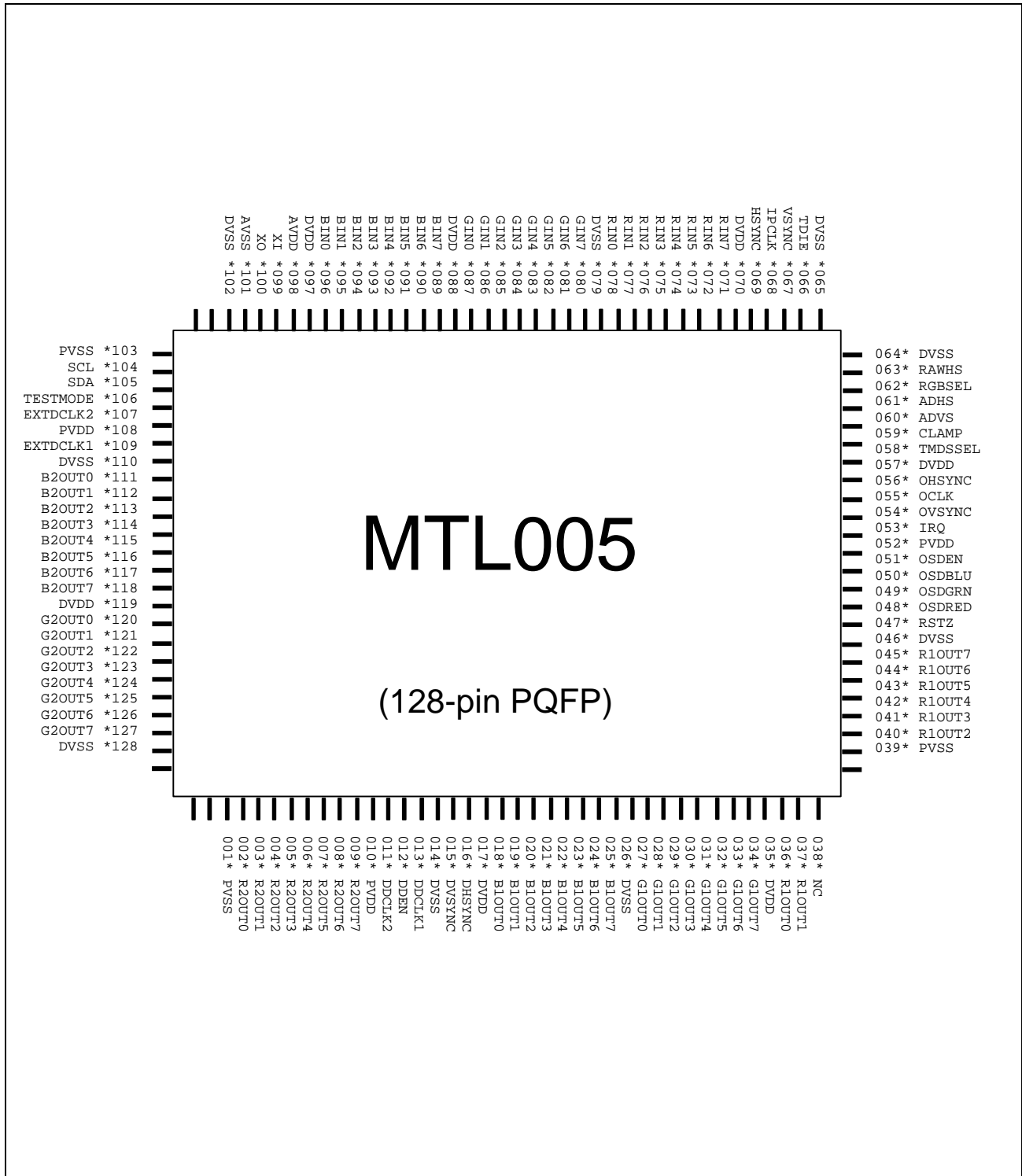

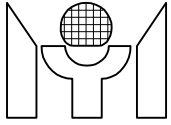

2. PIN DESCRIPTION

ADC Input Interface (RGB or YUV or TMDS Input Data)

Name	Type	Pin#	Description
IPCLK	I	68	Input pixel clock
VSYNC	I	67	Input Vertical sync
HSYNC/CS	I	69	Input Horizontal or Composite sync
RIN[7:0]/YIN[7:0]	I	71-78	Red or Y channel or TMDS input data
GIN[7:0]/UVIN[7:0]	I	80-87	Green or UV channel or TMDS input data
BIN[7:0]	I	89-96	Blue or TMDS input data, or Control bit for YUV video input Bit 4: VPHREF, Video input Horizontal reference signal Bit 3: VPVS, Video input VSYNC signal Bit 2: VPODD, Video input ODD/EVEN field signal Bit 1: VPHS, Video input HSYNC signal Bit 0: VPCLK, Video input clock signal
RAWHS	I	63	Input source HSYNC for measurement
TDIE	I	66	TMDS digital input enable
RGBSEL	O	62	Input select. 1:RGB input, 0:YUV input
TMDSSSEL	O	58	TMDS input select, active high
CLAMP	O	59	Clamp pulse output for ADC

Display Output Interface

Name	Type	Pin#	Description
DDEN	O	12	Display data output enable
DVSYNC	O	15	Display Vertical sync output
DHSYNC	O	16	Display Horizontal sync output
DDCLK1	O	13	Display output clock 1
DDCLK2	O	11	Display output clock 2
R1OUT[7:0]	O	45-40, 37-36	Red output even data , bit[7:2] for 6-bit panel
G1OUT[7:0]	O	34-27	Green output even data , bit[7:2] for 6-bit panel
B1OUT[7:0]	O	25-18	Blue output even data , bit[7:2] for 6-bit panel
R2OUT[7:0]	O	9-2	Red output odd data , bit[7:2] for 6-bit panel
G2OUT[7:0]	O	127-120	Green output odd data , bit[7:2] for 6-bit panel
B2OUT[7:0]	O	118-111	Blue output odd data , bit[7:2] for 6-bit panel

Host Interface

Name	Type	Pin#	Description
RST#	I	47	System reset input, active low.
SCL	I	104	Serial bus clock
SDA	I/O	105	Serial bus data
TESTMODE	I	106	Test Mode, Normally grounded.
IRQ	O	53	Interrupt request output

OSD Interface

Name	Type	Pin#	Description
OCLK	O	55	Clock for external OSD
OVSYNC	O	54	Vertical sync for external OSD
OHSYNC	O	56	Horizontal sync for external OSD
OSDRED	I	48	OSD red input
OSDGRN	I	49	OSD green input
OSDBLU	I	50	OSD blue input
OSDEN	I	51	OSD overlay enable

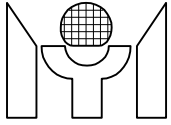

Other Interface

Name	Type	Pin#	Description
XI	I	99	Oscillator frequency input
XO	O	100	Oscillator frequency output
EXTDCLK1	I	109	External display clock input 1
EXTDCLK2	I	107	External display clock input 2
ADVS	O	60	Vertical sync for A/D converter
ADHS	O	61	Horizontal sync for A/D converter
NC	-	38	No connection

3.3V Power and Ground

Name	Pin#	Description
DVDD	17, 35, 57, 70, 88, 97, 119	Digital power 3.3V
DVSS	14, 26, 46, 64, 65, 79, 102, 110, 128	Digital ground
PVDD	10, 52, 108	Pad power 3.3V
PVSS	1, 39, 103	Pad ground
AVDD	98	Analog power 3.3V
AVSS	101	Analog ground

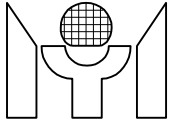

3. FUNCTIONAL DESCRIPTION

3.1 Input Processor

General Description

The function of Input Interface is to provide the interface between MTL005 and external input devices. It can process both non-interlaced and interlaced RGB graphic input, YUV video input, and digital RGB input compliant with digital LVDS/PanelLink TMDS interface. It also contains the built-in YUV to RGB color space converter.

3.1.1 RGB Input Format

Since MTL005 is a low cost solution, the RGB input port can only work in Single Pixel mode (24 bits). The R/G/BIN ports are sampled at the rising edge of the RGB input clock.

3.1.2 TMDS Input Format

The Digital RGB input port works likewise as described in Sec 3.1.1 except one more input pin is needed: Digital Input Enable DIEN.

With a single pixel input interface, the supported format is up to true color, including 18 bit/pixel or 24 bit/pixel.

3.1.3 YUV Input Format

The YUV input port supports interlaced video data from the most common video decoder ICs like SAA711x. The 16 bit data bus is shared with the ports RIN[7:0] and GIN[7:0]. The 16 bit data is sampled at the rising edge of the shared video clock VPCLK when the shared data enable HREF is active. The supported formats are YUV4:1:1 and YUV4:2:2 with CCIR601/CCIR656 standard.

3.1.4 Input HSYNC Path

Besides the pin HSYNC, MTL005 provides another pin RAWHS to support Sync Processor in MTL005. Generally, the HSYNC generated by an ADC may have a very narrow pulse width and a different polarity from the original HSYNC provided by the source. The RAWHS input provides the path of original HSYNC connection to MTL005, which makes Sync Processor in MTL005 work correctly.

3.1.5 YUV to RGB Converter

It is used to convert YCbCr format into RGB format. The basic equations are as follows:

$$\begin{aligned}R &= Y + 1.371(Cr - 128) \\G &= Y - 0.698(Cr - 128) - 0.336(Cb - 128) \\B &= Y + 1.732(Cb - 128)\end{aligned}$$

3.1.6 De-interlace mode

For interlace input, MTL005 features several de-interlacing algorithms for processing interlaced video data depending on the type of input images.

Toggle Mode

In this mode, only one field is displayed at the time. First field and second field is toggled displayed. The missing lines are calculated from duplicating the neighbor lines.

Spatial Mode

In this mode, two fields are toggled displayed, just like Toggle mode. The missing lines are calculated from interpolating the neighbor lines. An average good quality for still and moving pictures is achieved in this mode.

3.1.7 Sync Processor

The V/H SYNC processing block performs the functions of Composite signal separation/insertion, SYNC inputs presence check, frequency counting, polarity detection and control. It contains a de-glitch circuit to filter out any pulse shorter than one OSC period treated as noises on V/H SYNC pulses.

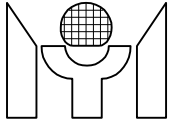

□ **V/H SYNC Frequency Counter**

MTL005 can measure VSYNC/HSYNC frequency counted in proper clocks and save the information in registers. Users can read it out to calculate VSYNC/HSYNC frequency as in the following formulas:

$$f_{\text{vsync}} = f_{\text{osc}} / N_{\text{vsync}} \times 1/256$$
$$f_{\text{hsync}} = f_{\text{osc}} / N_{\text{hsync}} \times 8$$

,Where f_{vsync} : VSYNC frequency
 f_{hsync} : HSYNC frequency
 f_{osc} : oscillator clock with 14.31818 MHz
 N_{vsync} : counted number of VSYNC
 N_{hsync} : counted number of HSYNC

□ **V/H SYNC Presence Check**

This function checks the input VSYNC, where Vpre flag is set when VSYNC is over 40Hz or cleared when VSYNC is under 10Hz, and the input HSYNC, where Hpre flag is set when HSYNC is over 10Khz or cleared when HSYNC is under 10Hz.

□ **V/H Polarity Detect**

This function detects the input VSYNC/HSYNC high and low pulse duty cycle. If the high pulse duration is longer than that of the low pulse, the negative polarity is asserted; otherwise, positive polarity is asserted.

□ **Composite SYNC separation/insertion**

MTL005 continuously monitors the input HSYNC. If the input VSYNC can be extracted from it, a CVpre flag is set. MTL005 can insert HSYNC pulse during Composite VSYNC's active time and the insertion frequency can adapt to original HSYNC's.

3.1.8 Auto Tune

Auto Tune function consists of Auto Position automatically centering the screen and Auto Calibration containing Phase Calibration, Histogram, Min/Max Value, and Pixel Grab described as below. With this auto adjustment support it is possible to measure the correct phase, frequency, gain, and offset of ADC. The horizontal and vertical back porches of input image and the horizontal and vertical active regions can also be measured. Firmware can adjust input image registers automatically by reading Auto Tune's registers in single or burst mode.

□ **Auto Position**

MTL005 provides Horizontal/Vertical back porch and active region values. Users can use these values to set input sample registers to aid in centering the screen automatically.

□ **Phase Calibration**

MTL005 provides Auto Calibration registers to measure the quality of current ADC's phase and frequency. The biggest Auto Calibration registers value means the right value of ADC's phase and frequency. MTL005 has two kinds of algorithms to calculate Auto Calibration's value. One is traditional Difference method, another is MYSON's proprietary method. It is suggested to use the latter one for better performance

□ **Histogram**

Histogram means the total number of input pixels below/above one threshold value, for individual R, G, B colors. This advanced function helps firmware to analyze ADC performance. Usually Firmware can use this information to measure ADC's noise margin, adjust its offset and gain, or even aid in the mode detection.

□ **Min/Max Value**

Min/Max value means minimum or maximum pixel value within the specified input active image region for each RGB channel. This information is usually used to adjust ADC's offset and gain.

□ **Pixel Grab**

Pixel Grab means users can grab a single input pixel at any one point. The position of the point can be programmed by users. This is another traditional method to measure ADC's phase and frequency.

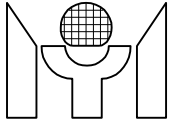

3.2 Video Processor

General Description

MTL005 possesses a powerful and programmable video processor by providing the following functions: Scaling Up/Down, Gain Control, Brightness Control, Gamma Correction, Dithering Control, and Flip & Mirror. The block diagram of Video Processor is as follows:

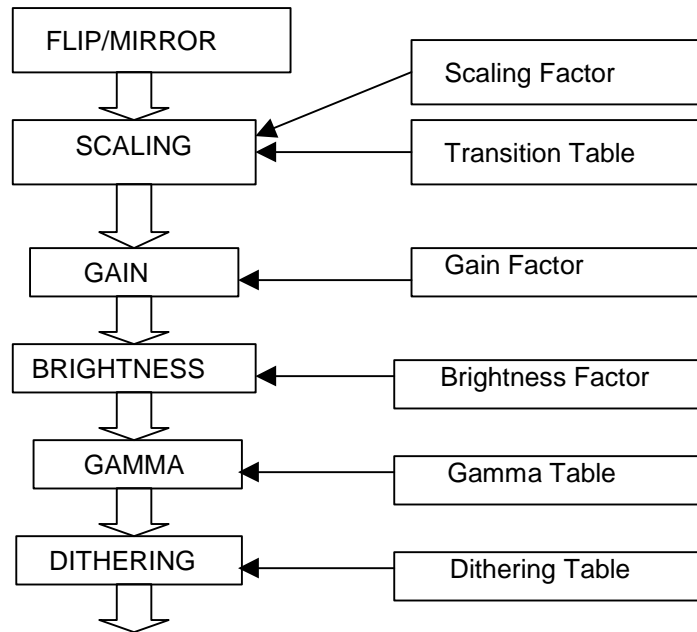

Fig. 3.2.1 Video Processor Block Diagram

3.2.1 Scaling

MTL005 provides scaling function up ranging from 1 to 32, and for both horizontal and vertical processing.

For scaling up, both horizontal and vertical processing, MTL005 provides four methods:

- Pass Mode:** Image will be passed through without considering any scaling factor.
- Duplicate Mode:** Image will be scaled up based on scaling factor. Every point of output image comes from the input. In this method, Output image will have the good contrast but may be non-uniformed.
- Bilinear Mode:** Image will be scaled up based on scaling factor. Every point of output image data will be filtered by bilinear filter. In this method, output image will have the good scaling quality but may be blurred.
- Interpolation Table Mode:** Image will be scaled up based on scaling factor. Every point of output image data will be filtered by user defined filter.

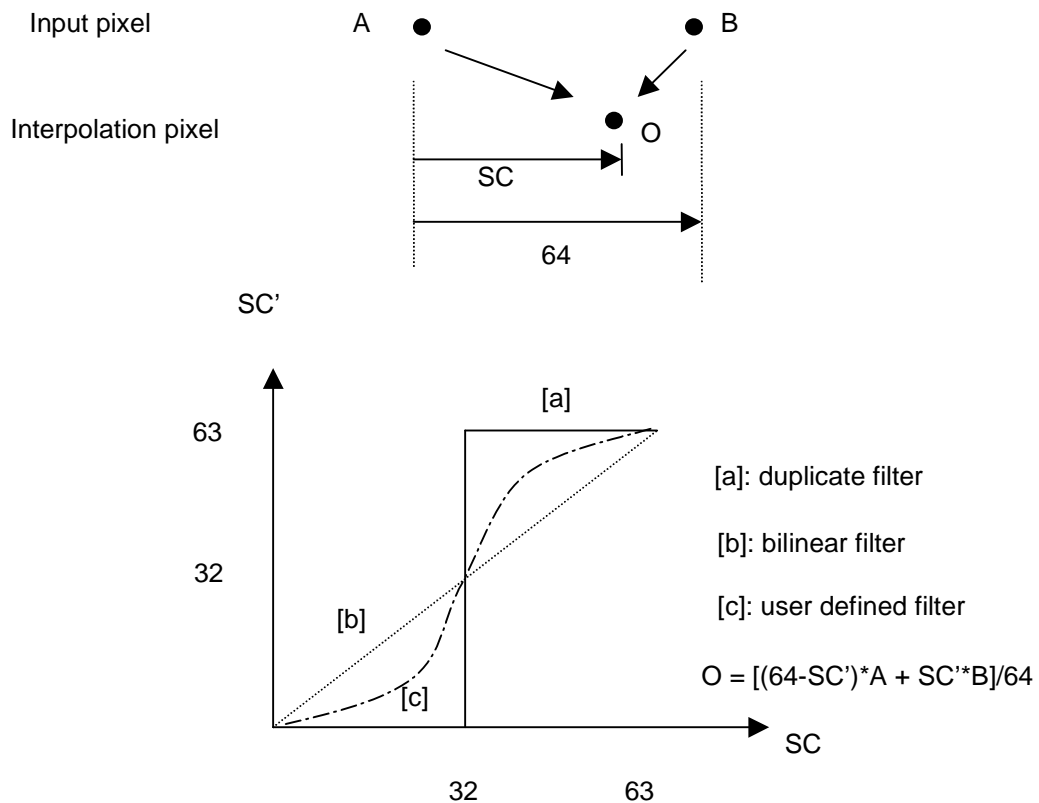
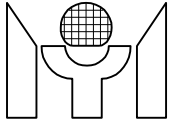

Fig. 3.2.2 Scaling filter

3.2.2 Gain/Brightness Control

MTL005 provides Gain and Brightness control to adjust the contrast and brightness of output color by programming gain and brightness coefficients. This adjustment is applied to RGB colors individually. Auto-white balance is possible by using this function.

3.2.3 Gamma Correction

Gamma Correction is used to compensate the non-linearity of LCD display panel. MTL005 contains a 8-bit Gamma table to fix this phenomenon.

3.2.4 Color Dithering

MTL005 supports true color (8 bits per color) or high color (6 bits per color) display.

In the latter case, users can turn on dithering function to avoid artificial contour due to truncation. For dithering, it supports two methods:

- Static dithering:** Dithering coefficient is fixed.
- Temporal dithering:** Dithering coefficient will change by time.

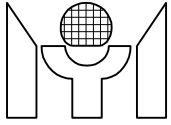

3.3 Output Processor

General Description

Output processor provides the interface for both LCD panel and OSD controller. output frame rate must be equal to input frame rate and output display time must be equal to input display time, because of no frame buffer.

3.3.1 Display Timing Generation

Output frame rate is equal to input frame and external frame buffer is not needed.

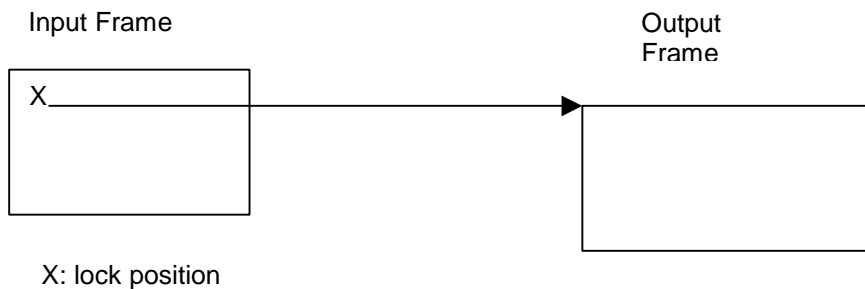

Fig. 3.3.1 Display Timing modes

3.3.2 OSD Overlay

MTL005 allows the integration of overlay data with the scaled output pixel stream. It provides a fully compatible OSD interface. Individual OSD clock, OSD HSYNC and OSD VSYNC are sent to external OSD device. MTL005 receives OSD Enable, OSD Red, OSD Green, and OSD Blue from external OSD device.

3.3.3 RGB Output Format

MTL005 output interface consists of two pixel ports, each containing Red, Green, and Blue color information with a resolution of 6/8 bits per color. These two ports are mapped to PORT1 and PORT2. The control signals for output port are display horizontal sync signal (DHSYNC), display vertical sync signal (DVSYNC) and display data enable signal (DDEN).

All the signals mentioned above are synchronous to the output clock. The output timing relative to the active edge of the output clock is programmable.

There are two RGB output formats:

Single Pixel Mode

It is designed to support TFT panels with single pixel input. Only PORT1 is active. The frequency of DCLK1 is equal to internal display clock.

Dual Pixel Mode

It is designed to support TFT panels with dual pixel input. PORT1 and PORT2 are used. The first pixel is at PORT1, and the second at PORT2.

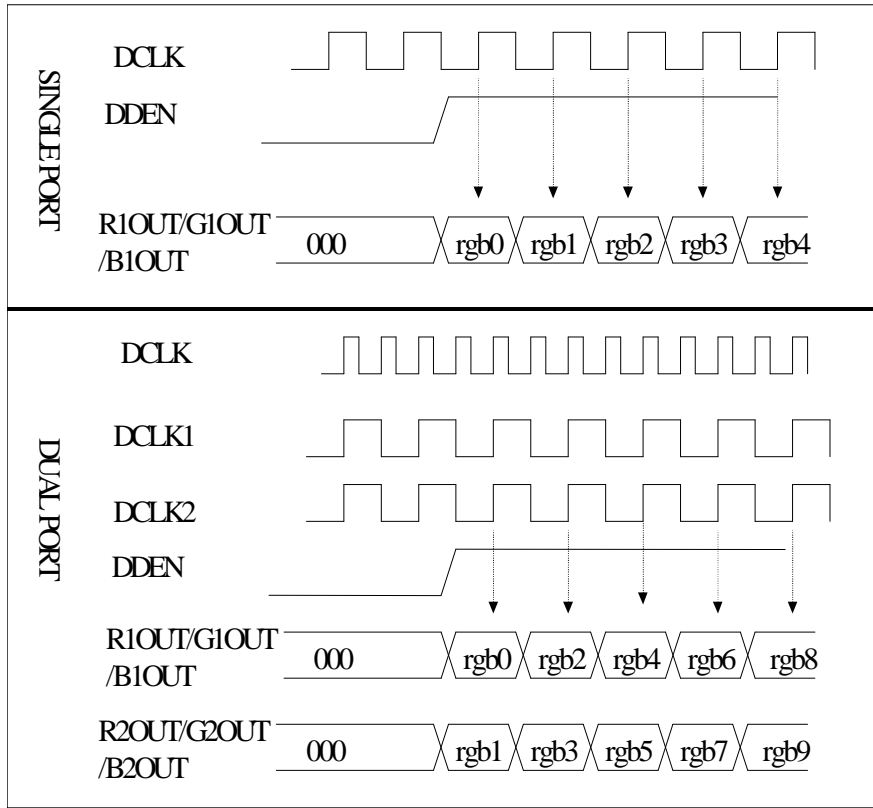
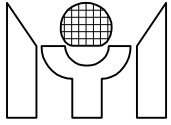
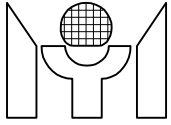

Fig. 3.3.2 Display Data Timing



3.4 Host Interface

General Description

The main function of Host Interface is to provide the interface between MTL005 and external CPU by 2-wire I2C Bus. It can generate all the I/O decoded control timing to control all the registers in MTL005.

3.4.1 I2C Serial Bus

The I2C serial interface use 2 wires, SCK (clock) and SDA(data I/O). The SCK is used as the sampling clock and SDA is a bi-directional signal for data. The communication must be started with a valid START condition, concluded with STOP condition and acknowledged with ACK condition by receiver.

The I2C bus device address of MTL005 is 0111010x.

SCK, serial bus clock.

SDA, bi-directional serial bus data.

The START condition means a HIGH to LOW transition of SDA when SCK is high, the STOP condition means a LOW to HIGH transition of SDA when SCK is high. And data of SDA only can change during SCK is low. Ref. Fig.3.5.1.

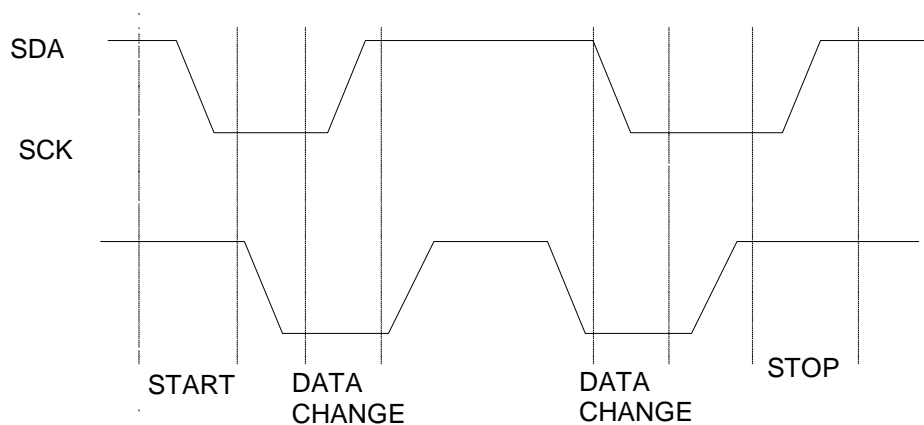

Fig. 3.4.1 START, STOP ,and DATA definition

The I2C interface supports Random Write, Sequential Write, Current Address Read, Random Read and Sequential Read operations.

□ Random Write

For Random Write operation, it contains the slave address with R/W bit set to 0 and the word address which is comprised of eight bits and provides to access any one of 256 bytes in the selected memory range. Upon receipt of the word address, MTL005 responds with an Acknowledge, waits the data bits again responding an Acknowledge, and then the master generates a stop condition. Ref. Fig.3.5.2.

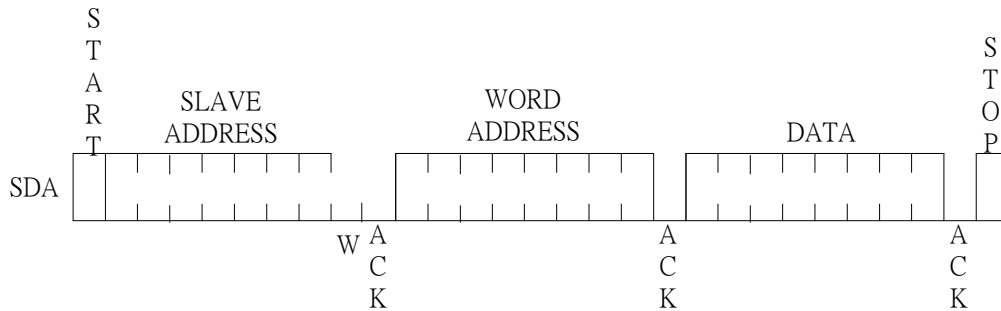
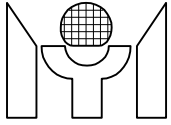

Fig. 3.4.2 Random Write

□ **Sequential Write**

The initial step of Sequential Write is the same as Random Write, after the receipt of each word data, MTL005 will respond with an Acknowledge and then internal address counter will increment by one for next data write. If the master would stop writing data, it generates stop condition. Ref. Fig. 3.5.3.

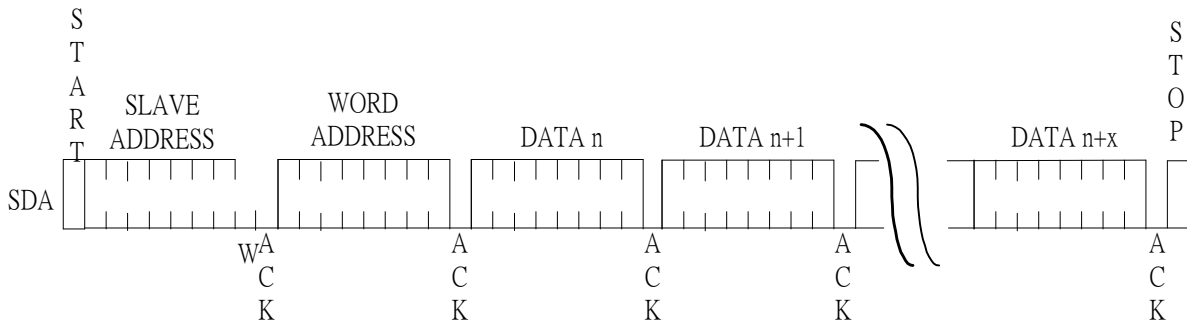

Fig. 3.4.3 Sequential Write

□ **Current Address Read**

MTL005 contains an address counter which maintains the last access address incremented by one. If the last access address is n, the read data should access from address n+1. Upon receipt of the slave address with R/W bit set to 1, MTL005 generates an Acknowledge and transmits eight bits data. After receiving data the master will generate a stop condition instead of an Acknowledge. Ref. Fig. 3.5.4.

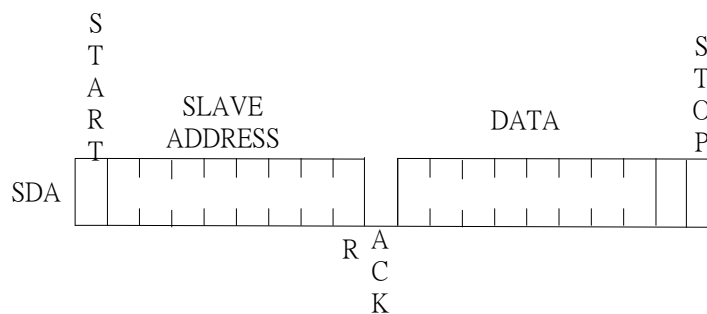
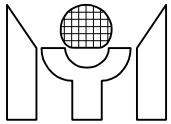

Fig. 3.5.4 Current Address Read



□ **Random Read**

The operation of Random Read allows accessing any address. Before reading data operation, it must issue a “dummy write” operation—a start condition, a slave address with R/W bit set to 0, and word address for read. After responding an Acknowledge, MTL005 then transmits eight bits data right after the master generating the start condition and slave address with R/W bit set to 1. After completion of receiving data, the master will generate a stop condition instead of an Acknowledge. Ref. Fig 3.5.5.

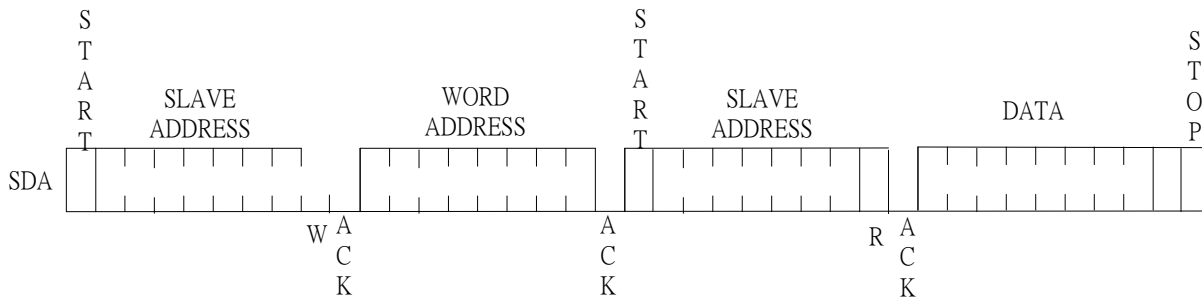

Fig. 3.4.5 Random Read

□ **Sequential Read**

The initial step can be as either Current Address Read or Random Read. The first read data is transmitted the same manner as other read methods. However, the master generates an Acknowledge indicating that it requires more data to read. MTL005 continues to output data for each Acknowledge received. The output data is sequential and the internal address counter increments by one for next read data. Ref. Fig. 3.5.6.

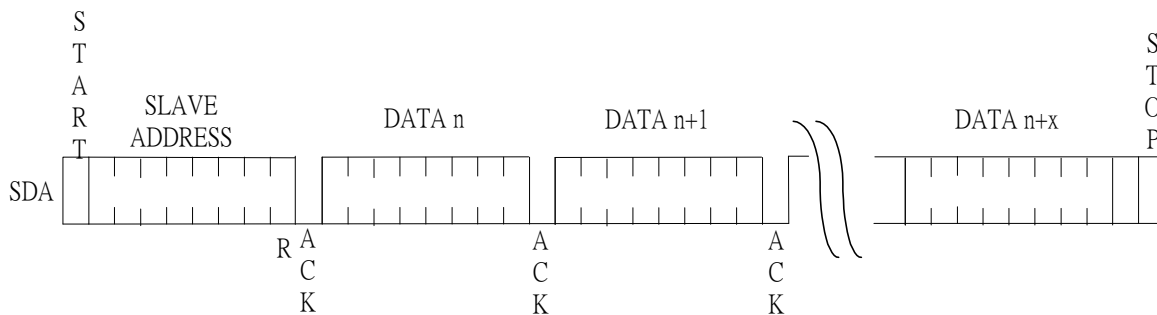

Fig. 3.4.6 Sequential Read

3.4.2 Interrupt

MTL005 supports one interrupt output signal (IRQ) which can be programmed to provide SYNC related or function status related interrupts to the system. Upon receiving the interrupt request, Firmware needs to first check the interrupt event by reading the Interrupt Flag Control registers (Reg. E8h and E9h) to decide what events are happening. After the operation is finished, Firmware needs to clear interrupt status by writing the same registers Reg. E8h and E9h. Furthermore, by using the Interrupt Flag Enable registers (Reg. EAh and EBh), each interrupt event can be masked.

3.4.3 Update Register Contents

I/O write operation to some consecutive register set can have the “Double Buffer” effect by setting the Reg. C1h/D4. Written data is first stored in an intermediate bank of latches and then transferred to the active register set by setting Reg. C1h/D1-0.

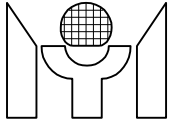

3.5 On-Chip PLL

General Description

The MTL005 needs two clock sources to drive synchronous circuits on chip. These clocks are generated from the internal Phase Lock Loop (PLL) circuits with reference to the oscillator clock which is applied to pin XI and XO by an external quartz crystal at 14.31818 MHz. First one is the same as to the oscillator clock at frequency (14.31818 MHz) to detect and measure graphic vertical and horizontal SYNC Frequency, Polarity as well as Presence. The second is the display clock for display controller on chip and output signals to LCD panel.

3.5.1 Reference Clock

It is the counting basis of counter values in SYNC Processor such as VS and HS period count registers; that is, the read back values from these registers must multiply the period of this clock to estimate VS and HS frequency. Incorporating with polarity and frequency information of VS and HS, it can show the input graphic image mode and pixel clock frequency.

3.5.2 Display Clock

This clock is the synchronous clock for LCD panel. According to the LCD panel resolution of applications, the display clock range is from 50 MHz to 200 MHz by means of choosing a set of appropriate values for M, N as well as R. The formula to calculate desired frequency of display clock is as follows:

$$f_{\text{mclk}} = f_{\text{osc}} \times (M+2) / (N+2) \times 1/R$$

Where

f_{mclk}	: the desired display clock
f_{osc}	: oscillator clock with 14.31818 MHz
M	: post-divider ratio
N	: pre-divider ratio
R	: optional divider ratio

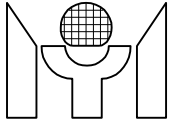

4. REGISTER DESCRIPTION

INPUT CONTROL REGISTERS

Address	Mode	Registers	Reset value
00h	R/W	Input Image Vertical Active Line Start - Low	00h
01h	R/W	Input Image Vertical Active Line Start - High	00h
02h	R/W	Input Image Vertical Active Lines - Low	00h
03h	R/W	Input Image Vertical Active Lines - High	00h
04h	R/W	Input Image Horizontal Active Pixel Start - Low	00h
05h	R/W	Input Image Horizontal Active Pixel Start - High	00h
06h	R/W	Input Image Horizontal Active Pixels - Low	00h
07h	R/W	Input Image Horizontal Active Pixels - High	00h
10h	R/W	Input Image Control Register 0	00h
11h	R/W	Input Image Control Register 1	00h
12h	R/W	Input Image Control Register 2	00h
13h	R/W	Input Image Control Register 3	00h
14h	R/W	Input Image Control Register 4	00h
15h	R/W	Input Image Control Register 5	00h
16h	R/W	Input Image Control Register 6	00h
1Ah	R/W	Input Delay Control 2	00h
1Ch	R/W	HS1 Sample Window Forward Extend	00h
1Dh	R/W	HS1 Sample Window Backward Extend	00h
1Fh	RO	Input Image Status Register	-
20h	R/W	Input Image Back Porch Guard Band	00h
21h	R/W	Input Image Front Porch Guard Band	00h

FRAME SYNC REGISTERS

Address	Mode	Registers	Reset value
2Ch	R/W	Input Image Vertical Lock Position - Low	00h
2Dh	R/W	Input Image Vertical Lock Position - High	00h
2Eh	R/W	Input Image Horizontal Lock Position - Low	00h
2Fh	R/W	Input Image Horizontal Lock Position - High	00h

AUTO CALIBRATION REGISTERS

Address	Mode	Registers	Reset value
30h	R/W	Auto Calibration Control 0	80h
31h	R/W	Auto Calibration Control 1	00h
34h	RO	Auto Calibration RED Value - Byte 0	-
35h	RO	Auto Calibration RED Value - Byte 1	-
36h	RO	Auto Calibration RED Value - Byte 2	-
37h	RO	Auto Calibration RED Value - Byte 3	-
38h	RO	Auto Calibration GREEN Value - Byte 0	-
39h	RO	Auto Calibration GREEN Value - Byte 1	-
3Ah	RO	Auto Calibration GREEN Value - Byte 2	-
3Bh	RO	Auto Calibration GREEN Value - Byte 3	-
3Ch	RO	Auto Calibration BLUE Value - Byte 0	-
3Dh	RO	Auto Calibration BLUE Value - Byte 1	-
3Eh	RO	Auto Calibration BLUE Value - Byte 2	-
3Fh	RO	Auto Calibration BLUE Value - Byte 3	-
40h	R/W	Pixel Grab V Reference Position - Low	00h

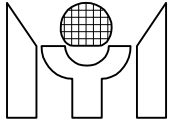

41h	R/W	Pixel Grab V Reference Position – High	00h
42h	R/W	Pixel Grab H Reference Position – Low	00h
43h	R/W	Pixel Grab H Reference Position – High	00h
44h	R/W	Histogram Reference Color - RED	00h
45h	R/W	Histogram Reference Color - GREEN	00h
46h	R/W	Histogram Reference Color - BLUE	00h

SYNC PROCESSOR REGISTERS

Address	Mode	Registers	Reset value
48h	R/W	SYNC Processor Control	00h
49h	R/W	Auto Position Control	00h
4Ah	R/W	Auto Position Reference Color - RED	00h
4Bh	R/W	Auto Position Reference Color - GREEN	00h
4Ch	R/W	Auto Position Reference Color - BLUE	00h
4Eh	R/W	Clamp Pulse Control 0	00h
4Fh	R/W	Clamp Pulse Control 1	00h
50h	RO	Input VS Period Count by REFCLK - Low	-
51h	RO	Input VS Period Count by REFCLK - High	-
52h	RO	Input V Back Porch Count by Input HS - Low	-
53h	RO	Input V Back Porch Count by Input HS - High	-
54h	RO	Input V Active Lines Count by Input HS - Low	-
55h	RO	Input V Active Lines Count by Input HS - High	-
56h	RO	Input V Total Lines Count by Input HS - Low	-
57h	RO	Input V Total Lines Count by Input HS - High	-
58h	RO	Input HS Period Count by REFCLK - Low	-
59h	RO	Input HS Period Count by REFCLK - High	-
5Ah	RO	Input H Back Porch Count by Input Pixel Clock - Low	-
5Bh	RO	Input H Back Porch Count by Input Pixel Clock - High	-
5Ch	RO	Input H Active Pixels Count by Input Pixel Clock - Low	-
5Dh	RO	Input H Active Pixels Count by Input Pixel Clock - High	-
5Eh	RO	Input H Total Pixels Count by Input Pixel Clock - Low	-
5Fh	RO	Input H Total Pixels Count by Input Pixel Clock - High	-

DISPLAY CONTROL REGISTERS

Address	Mode	Registers	Reset value
60h	R/W	Display Vertical Total - Low	00h
61h	R/W	Display Vertical Total - High	00h
62h	R/W	Display Vertical SYNC End- Low	00h
63h	R/W	Display Vertical SYNC End - High	00h
64h	R/W	Display Vertical Active Start - Low	00h
65h	R/W	Display Vertical Active Start - High	00h
66h	R/W	Display Vertical Active End - Low	00h
67h	R/W	Display Vertical Active End - High	00h
70h	R/W	Display Horizontal Total - Low	00h
71h	R/W	Display Horizontal Total - High	00h
72h	R/W	Display Horizontal SYNC End - Low	00h
73h	R/W	Display Horizontal SYNC End - High	00h
74h	R/W	Display Horizontal Active Start - Low	00h
75h	R/W	Display Horizontal Active Start - High	00h

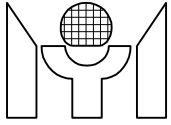

76h	R/W	Display Horizontal Active End - Low	00h
77h	R/W	Display Horizontal Active End - High	00h
7Fh	R/W	NFB Timing Control	60h
88h	R/W	Output Image Control Register 0	00h
89h	R/W	Output Image Control Register 1	00h
8Ah	R/W	Output Image Control Register 2	00h
90h	R/W	Color Gain Control - RED	80h
91h	R/W	Color Gain Control - GREEN	80h
92h	R/W	Color Gain Control - BLUE	80h
93h	R/W	Brightness Control - RED	00h
94h	R/W	Brightness Control - GREEN	00h
95h	R/W	Brightness Control - BLUE	00h
9Fh	R/W	Gamma Table Data Port	-
A0h	R/W	OSD Control Register 0	08h
A1h	R/W	OSD Control Register 1	00h
A2h	R/W	OSD Control Register 2	00h
A4h	R/W	Output Invert Control	00h
A5h	R/W	Output Tri-State Control	00h
A6h	R/W	Output Clocks Delay Adjustment	00h
A7h	R/W	Output Clocks Duty Cycle Adjustment	00h
A9h	R/W	Output Miscellaneous Control	00h
AAh	R/W	Output Vertical Active Line Number - Low	FFh
ABh	R/W	Output Vertical Active Line Number - High	02h
ACh	RO	Output Horizontal Total Pixel Number – Low	-
ADh	RO	Output Horizontal Total Pixel Number – High	-
A Eh	RO	Output Horizontal Total Residue Number – Low	-
AFh	RO	Output Horizontal Total Residue Number - High	-

ZOOM CONTROL REGISTERS

Address	Mode	Registers	Reset value
B0h	R/W	Zoom Control Register 0	00h
B1h	R/W	Zoom Control Register 1	00h
B4h	R/W	Zoom Vertical Scale Ratio - Low	00h
B5h	R/W	Zoom Vertical Scale Ratio - High	00h
B6h	R/W	Zoom Horizontal Scale Ratio - Low	00h
B7h	R/W	Zoom Horizontal Scale Ratio – High	00h
BFh	R/W	Interpolation Table Data Port	-

HOST CONTROL REGISTERS

Address	Mode	Registers	Reset value
C1h	R/W	Host Control Register 1	00h
CBh	RO	Host Access Mode Status	-

CLOCK CONTROL REGISTERS

Address	Mode	Registers	Reset value
E0h	R/W	Clock Control Register	00h

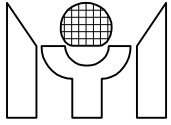

E1h	WO	Clock Synthesizer Value Load	-
E2h	R/W	Clock Synthesizer N Value	0Bh
E3h	R/W	Clock Synthesizer M Value	32h
E6h	R/W	Clock Synthesizer R Value	00h

INTERRUPT CONTROL REGISTERS

Address	Mode	Registers	Reset value
E8h	R/W	SYNC Interrupt Flag Control	00h
E9h	R/W	General Interrupt Flag Control	00h
EAh	R/W	SYNC Interrupt Enable Control	00h
EBh	R/W	General Interrupt Enable Control	00h
ECh	R/W	HS Frequency Change interrupt Compare	00h

MISCELLANEOUS REGISTERS

Address	Mode	Registers	Reset value
F1h	R/W	Power Management Control	00h

Input Image Vertical Active Line Start - Low (Address 00h) (R/W)

It defines the low byte of the start position of the Vertical Active Window.

D7-0 IV_ACT_START[7:0]

Input Image Vertical Active Line Start - High (Address 01h) (R/W)

It defines the high byte of the start position of the Vertical Active Window.

D7-3 Reserved

D2-0 IV_ACT_START[10:8]

Input Image Vertical Active Lines - Low (Address 02h) (R/W)

It defines the low byte of the number of active lines of the Vertical Active Window.

D7-0 IV_ACT_LEN[7:0]

Input Image Vertical Active Lines - High (Address 03h) (R/W)

It defines the high byte of the number of active lines of the Vertical Active Window.

D7-3 Reserved

D2-0 IV_ACT_LEN[10:8]

Input Image Horizontal Active Pixel Start - Low (Address 04h) (R/W)

It defines the low byte of the start position of the Horizontal Active Window.

D7-0 IH_ACT_START[7:0]

Input Image Horizontal Active Pixel Start - High (Address 05h) (R/W)

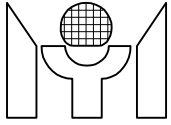

It defines the high byte of the start position of the Horizontal Active Window.

D7-3 Reserved

D2-0 IH_ACT_START[10:8]

Input Image Horizontal Active Pixels - Low (Address 06h) (R/W)

It defines the low byte of the number of active pixels of the Horizontal Active Window.

D7-0 IH_ACT_WIDTH[7:0]

Input Image Horizontal Active Pixels - High (Address 07h) (R/W)

It defines the high byte of the number of active pixels of the Horizontal Active Window.

D7-3 Reserved

D2-0 IH_ACT_WIDTH[10:8]

Input Image Control Register 0 (Address 10h) (R/W)

- D7 Horizontal Sampling Point Reference
 0: from Input HSYNC
 1: from Input HREF (only for Video Decoder)

- D6 Input YCBCR Format
 0: 4-2-2
 1: 4-1-1

- D5 Digital RGB 6 bit Mode
 0: 8 bits
 1: 6 bits

- D4 Digital RGB Mode Select
 0: RGB Input from ADC
 1: RGB Input from Panel Link

- D3 Input Image Format
 0: RGB888
 1: YCBCR

- D2 Reserved

- D1 Input Image Source
 0: from Graphic source through ADC
 1: from Video source through Video Decoder like SAA7111A

- D0 ADC Configuration
 0: Double Pixel mode
 1: Single Pixel mode

Input Image Control Register 1 (Address 11h) (R/W)

D7-5 Reserved

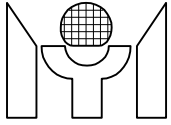

-
-
- D4 De-interlace mode Select
0: Spatial Filtering write mode
1: Toggle Field write mode
- D3 CCIR656 mode Enable
0: Disable
1: Enable
- D2-0 Reserved

Input Image Control Register 2 (Address 12h) (R/W)

- D7 Input ODD Field Invert
0: Normal
1: Invert
- D6 External Input Interlace Select
0: Non-interlace
1: Interlace
- D5 External Input VSYNC Polarity
0: Active Low
1: Active High
- D4 External Input HSYNC Polarity
0: Active Low
1: Active High
- D3 Input ODD Field Source
0: from Internal Detection
1: from External pin
- D2 Input Interlace Source
0: from Internal detection
1: from Register setting (D6)
- D1 Input VSYNC Polarity Source
0: from Internal detection
1: from Register setting (D5)
- D0 Input HSYNC Polarity Source
0: from Internal detection
1: from Register setting (D4)

Input Image Control Register 3 (Address 13h) (R/W)

- D7 Active Position Area for Auto Position in TMDS
0: from Internal Detection
1: from External Data Enable (TDIE)
- D6-3 Reserved
- D2 Sync On Green Select
0: Select Normal HSYNC/ Composite Sync
1: Select Sync On Green

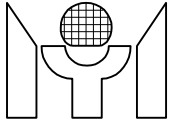

D1 Input Vertical Timing based on VSYNC
0: Leading Edge
1: Trailing Edge

D0 Input Horizontal Timing based on HSYNC
0: Leading Edge
1: Trailing Edge

Input Image Control Register 4 (Address 14h) (R/W)

D7 Input ODD Field Detection Point
0: at the start of VSYNC pulse.
1: at the end of VSYNC pulse.

D6-5 Reserved

D4 Input Image CBCR Order Swap
0: Normal
1: Swap

D3-0 Reserved

Input Image Control Register 5 (Address 15h) (R/W)

D7 Horizontal Pixel Valid Select
0: from Internal Programming
1: from External HREF

D6-0 Reserved

Input Image Control Register 6 (Address 16h) (R/W)

D7 Reserved

D6 Bit Order in Port A
0: Normal
1: Reverse

D5-3 Reserved

D2 ADC HS Polarity Invert when D1=1
0: Active Low
1: Active High

D1 Raw HS path Enable
0: Disable
1: Enable

D0 Reserved

Input Delay Control 2 (Address 1Ah) (R/W)

D7-4 Input VSYNC Delay Adjustment
1111: 7 IDCLKs delay
1110: 6 IDCLKs delay
1101: 5 IDCLKs delay

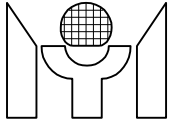

1100: 4 IDCLKs delay
1011: 3 IDCLKs delay
1010: 2 IDCLKs delay
1001: 1 IDCLK delay
1000: No delay
0111: 7ns gate delay
0110: 6ns gate delay
0101: 5ns gate delay
0100: 4ns gate delay
0011: 3ns gate delay
0010: 2ns gate delay
0001: 1ns gate delay
0000: No delay

D3-0 Input HSYNC Delay Adjustment
16 steps to change, each of them is 1ns delay/step.

Input HS Pulse Width Forward Extend (Address 1Ch) (R/W)

D7-0 Input HS Pulse Width Forward Extend by IDCLK
HS1FWEXT[7:0]: Used when Interlace First/Second Field Detection.

Input HS Pulse Width Backward Extend (Address 1Dh) (R/W)

D7-0 Input HS Pulse Width Backward Extend by IDCLK
HS1BWEXT[7:0]: Used when Interlace First/Second Field Detection.

Input Image Status Register (Address 1Fh) (RO)

D7 Display VSYNC Monitor
Show Display VSYNC signal directly.

D6 Input VSYNC Monitor
Show Input VSYNC signal directly.

D5 External Input Interlace Status
0: Non-interlace
1: Interlace

D4 Extracted CVSYNC Present Status
0: Not Present
1: Present

D3 External Input VSYNC Present Status
0: Not Present
1: Present

D2 External Input HSYNC Present Status
0: Not Present
1: Present

D1 External Input VSYNC Polarity Status
0: Active Low
1: Active High

D0 External Input HSYNC Polarity Status

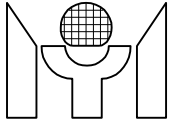

0: Active Low
1: Active High

Input Image Back Porch Guard Band (Address 20h) (R/W)

D7-0 Input Image Back Porch Guard Band by IDCLK
HBPGb[7:0]: Used in Auto Position detection to mask out unwanted data.

Input Image Front Porch Guard Band (Address 21h) (R/W)

D7-0 Input Image Front Porch Guard Band by IDCLK
HFPGB[7:0]: Used in Auto Position detection to mask out unwanted data.

Input Image Vertical Lock Position - Low (Address 2Ch) (R/W)

It defines the low byte of the number of input lines where Display image timing synchronizes the input image source.

D7-0 IPV_LOCK_POS[7:0]

Input Image Vertical Lock Position - High (Address 2Dh) (R/W)

It defines the high byte of the number of input lines where Display image timing synchronizes the input image source.

D7-3 Reserved

D2-0 IPV_LOCK_POS[10:8]

Input Image Horizontal Lock Position - Low (Address 2Eh) (R/W)

It defines the low byte of the number of input pixel clocks where Display image timing synchronizes the input image source.

D7-0 IPH_LOCK_POS[7:0]

Input Image Horizontal Lock Position - High (Address 2Fh) (R/W)

It defines the high byte of the number of input pixel clocks where Display image timing synchronizes the input image source.

D7-3 Reserved

D2-0 IPH_LOCK_POS[10:8]

Auto Calibration Control 0 (Address 30h) (R/W)

D7 Pixel Grab Ready Flag (RO)
0: Ready
1: Not Ready

D6 Pixel Grab Update Enable
0: Stop updating
1: Continue updating

D5 Threshold Select

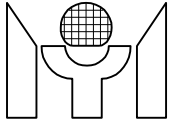

Used in Histogram mode or MIN/MAX mode.
0: High bound / MAX
1: Low bound / MIN

D4 Phase Calibration Method Select
0: MYSON proprietary method
1: Difference Value method

D3-2 Auto Calibration Modes Select
The measured value is available one item at a time,
selected as shown:
00: Phase Calibration Mode
01: Histogram Mode
10: MIN/MAX Mode
11: Pixel Grab Mode

D1 Auto Calibration Burst Mode Enable
(except Pixel Grab Mode)
0: Single Mode
1: Burst Mode

D0 Auto Calibration Enable **(W)**
(except Pixel Grab Value)
0: Disable
1: Enable
Auto Calibration Ready Flag **(R)**
0: Ready
1: Not Ready

Auto Calibration Control 1 (Address 31h) (R/W)

D7-3 Reserved

D2-0 Mask LSBs of Input Image Select
000: No Mask
001: Mask bit0
010: Mask bit0,1
011: Mask bit0,1,2
100: Mask bit0,1,2,3
101: Mask bit0,1,2,3,4
110: Mask bit0,1,2,3,4,5
111: Mask bit0,1,2,3,4,5,6

Auto Calibration RED Value - Byte 0 (Address 34h) (RO)

It states the byte 0 of the number of Phase Calibration RED value in one frame or the byte 0 of the number of Histogram Red value in one frame or the Pixel Grab RED value in one frame of Non_interlace mode or FIRST field of Interlace mode.

D7-0 CALVAL_R[7:0]

Auto Calibration RED Value - Byte 1 (Address 35h) (RO)

It states the byte 1 of the number of Phase Calibration RED value in one frame or the byte 1 of the number of Histogram Red value in one frame or the Pixel Grab GREEN value in one frame of Non_interlace mode or FIRST field of Interlace mode.

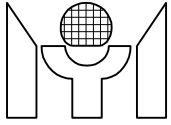

D7-0 CALVAL_R[15:8]

Auto Calibration RED Value - Byte 2 (Address 36h) (RO)

It states the byte 2 of the number of Phase Calibration RED value in one frame or the byte 2 of the number of Histogram Red value in one frame or the Pixel Grab BLUE value in one frame of Non_interlace mode or FIRST field of Interlace mode.

D7-0 CALVAL_R[23:16]

Auto Calibration RED Value - Byte 3 (Address 37h) (RO)

It states the byte 3 of the number of Phase Calibration RED value in one frame.

D7-6 Reserved

D5-0 CALVAL_R[29:24]

Auto Calibration GREEN Value - Byte 0 (Address 38h) (RO)

It states the byte 0 of the number of Phase Calibration GREEN value in one frame or the byte 0 of the number of Histogram GREEN value in one frame or the Pixel Grab RED value in one frame of Non_interlace mode or SECOND field of Interlace mode.

D7-0 CALVAL_G[7:0]

Auto Calibration GREEN Value - Byte 1 (Address 39h) (RO)

It states the byte 1 of the number of Phase Calibration GREEN value in one frame or the byte 1 of the number of Histogram GREEN value in one frame or the Pixel Grab GREEN value in one frame of Non_interlace mode or SECOND field of Interlace mode.

D7-0 CALVAL_G[15:8]

Auto Calibration GREEN Value - Byte 2 (Address 3Ah) (RO)

It states the byte 2 of the number of Phase Calibration GREEN value in one frame or the byte 2 of the number of Histogram GREEN value in one frame or the Pixel Grab BLUE value in one frame of Non_interlace mode or SECOND field of Interlace mode.

D7-0 CALVAL_G[23:16]

Auto Calibration GREEN Value - Byte 3 (Address 3Bh) (RO)

It states the byte 3 of the number of Phase Calibration GREEN value in one frame.

D7-6 Reserved

D5-0 CALVAL_G[29:24]

Auto Calibration BLUE Value - Byte 0 (Address 3Ch) (RO)

It states the byte 0 of the number of Phase Calibration BLUE value in one frame or

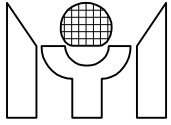

the byte 0 of the number of Histogram BLUE value in one frame or the MIN/MAX RED value in one frame.

D7-0 CALVAL_B[7:0]

Auto Calibration BLUE Value - Byte 1 (Address 3Dh) (RO)

It states the byte 1 of the number of Phase Calibration BLUE value in one frame or the byte 1 of the number of Histogram BLUE value in one frame or the MIN/MAX GREEN value in one frame.

D7-0 CALVAL_B[15:8]

Auto Calibration BLUE Value - Byte 2 (Address 3Eh) (RO)

It states the byte 2 of the number of Phase Calibration BLUE value in one frame or the byte 2 of the number of Histogram BLUE value in one frame or the MIN/MAX BLUE value in one frame.

D7-0 CALVAL_B[23:16]

Auto Calibration BLUE Value - Byte 3 (Address 3Fh) (RO)

It states the byte 3 of the number of Phase Calibration BLUE value in one frame.

D7-6 Reserved

D5-0 CALVAL_B[29:24]

Pixel Grab V Reference Position - Low (Address 40h) (R/W)

It states the low byte of Vertical Reference Position in Pixel Grab Mode.

D7-0 VGRAB_POS[7:0]

Pixel Grab V Reference Position - High (Address 41h) (R/W)

It states the high byte of Vertical Reference Position in Pixel Grab Mode.

D7-3 Reserved

D2-0 VGRAB_POS[10:8]

Pixel Grab H Reference Position - Low (Address 42h) (R/W)

It states the low byte of Horizontal Reference Position in Pixel Grab Mode.

D7-0 HGRAB_POS[7:0]

Pixel Grab H Reference Position - High (Address 43h) (R/W)

It states the high byte of Horizontal Reference Position in Pixel Grab Mode.

D7-3 Reserved

D2-0 HGRAB_POS[10:8]

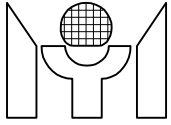

Histogram Reference Color - RED (Address 44h) (R/W)

It states the Histogram Reference RED Color in Histogram Mode.

D7-0 HIST_R[7:0]

Histogram Reference Color - GREEN (Address 45h) (R/W)

It states the Histogram Reference GREEN Color in Histogram Mode.

D7-0 HIST_G[7:0]

Histogram Reference Color - BLUE (Address 46h) (R/W)

It states the Histogram Reference BLUE Color in Histogram Mode.

D7-0 HIST_B[7:0]

SYNC Processor Control (Address 48h) (R/W)

D7-2 Reserved

D1-0 SYNC Source
00: from H/V SYNC
01: from CVSYNC (Composite SYNC)
1x: Auto switch to CVSYNC when CVSYNC is present, but VSYNC not.

Auto Position Control (Address 49h) (R/W)

D7-2 Reserved

D1 Auto Position Burst Mode Enable
0: Single Mode
1: Burst Mode

D0 Auto Position Enable **(W)**
0: Disable
1: Enable
Auto Position Ready Flag **(R)**
0: Ready
1: Not Ready

Auto Position Reference Color - RED (Address 4Ah) (R/W)

It defines the red component color for selecting between black and non-black pixels.

D7-0 REF_COLOR_RED[7:0]

Auto Position Reference Color - GREEN (Address 4Bh) (R/W)

It defines the green component color for selecting between black and non-black pixels.

D7-0 REF_COLOR_GREEN[7:0]

Auto Position Reference Color - BLUE (Address 4Ch) (R/W)

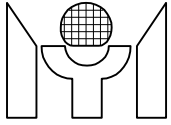

It defines the blue component color for selecting between black and non-black pixels.

D7-0 REF_COLOR_BLUE[7:0]

Clamp Pulse Control 0 (Address 4Eh) (R/W)

- D7 Clamp Pulse Mask
0: Normal
1: Mask out Clamp Pulse
- D6 Clamp Pulse Start Reference Edge
0: From Input HSYNC trailing edge.
1: From Input HSYNC leading edge.
- D5 Clamp Pulse output Polarity
0: Active High
1: Active Low
- D4-0 Clamp Pulse Start
Start of Clamp Pulse after the selected edge of Input HSYNC by Input DCLK.

Clamp Pulse Control 1 (Address 4Fh) (R/W)

- D7 Clock Source for Clamp Pulse Generation
0: from Input clock, IDCLK
1: from OSC clock, REFCLK
- D6-5 Reserved
- D4-0 Clamp Pulse Width
To Adjust Clamp Pulse Width by Input DCLK.

Input VS Period Count by REFCLK - Low (Address 50h) (RO)

It states the low byte of the number of REFCLK of the Vertical Sync period measurement.

D7-0 VSPRD[7:0]

Input VS Period Count by REFCLK - High (Address 51h) (RO)

It states the high byte of the number of REFCLK of the Vertical Sync period measurement.

D7-4 Reserved

D3-0 VSPRD[11:8]

Input V Back Porch Count by Input HS - Low (Address 52h) (RO)

It states the low byte of the number of lines between the end of VSYNC and the active image.

D7-0 VBPW[7:0]

Input V Back Porch Count by Input HS - High (Address 53h) (RO)

It states the high byte of the number of lines between the end of VSYNC and the active image

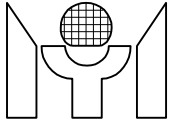

D7-3 Reserved

D2-0 VBPW[10:8]

Input V Active Image Count by Input HS - Low (Address 54h) (RO)

It states the low byte of the number of the active image lines.

D7-0 VACTW[7:0]

Input V Active Image Count by Input HS - High (Address 55h) (RO)

It states the high byte of the number of the active image lines

D7-3 Reserved

D2-0 VACTW[10:8]

Input V Total Image Count by Input HS - Low (Address 56h) (RO)

It states the low byte of the number of the total image lines.

D7-0 VTOTW[7:0]

Input V Total Image Count by Input HS - High (Address 57h) (RO)

It states the high byte of the number of the total image lines.

D7-3 Reserved

D2-0 VTOTW[10:8]

Input HS Period Count by REFCLK - Low (Address 58h) (RO)

It states the low byte of the number of REFCLKs of the Horizontal Sync period measurement.

D7-0 HSPRD[7:0]

Input HS Period Count by REFCLK - High (Address 59h) (RO)

It states the high byte of the number of REFCLKs of the Horizontal Sync period measurement.

D7-5 Reserved

D4-0 HSPRD[12:8]

Input H Back Porch Count by Input Pixel Clock -Low (Address 5Ah) (RO)

It states the low byte of the number of pixels between the end of HSYNC and the active image.

D7-0 HBPW[7:0]

Input H Back Porch Count by Input Pixel Clock -High (Address 5Bh) (RO)

It states the high byte of the number of pixels between the end of HSYNC and the active image.

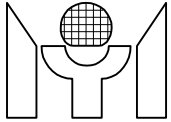

D7-3 Reserved

D2-0 HBPW[10:8]

Input H Active Image Count by Input Pixel Clock-Low(Address 5Ch) (RO)

It states the low byte of the number of the Horizontal active image pixels.

D7-0 HACTW[7:0]

Input H Active Image Count by Input Pixel Clock-High(Address 5Dh)(RO)

It states the high byte of the number of the Horizontal active image pixels.

D7-3 Reserved

D2-0 HACTW[10:8]

Input H Total Image Count by Input Pixel Clock- Low (Address 5Eh) (RO)

It states the low byte of the number of the Horizontal total image pixels.

D7-0 HTOTW[7:0]

Input H Total Image Count by Input Pixel Clock- High (Address 5Fh) (RO)

It states the high byte of the number of the Horizontal total image pixels.

D7-3 Reserved

D2-0 HTOTW[10:8]

Display Vertical Total - Low (Address 60h) (R/W)

It defines the low byte of the number of lines per display frame.

D7-0 DV_TOTAL[7:0]

Display Vertical Total - High (Address 61h) (R/W)

It defines the high byte of the number of lines per display frame.

D7-3 Reserved

D2-0 DV_TOTAL[10:8]

Display Vertical SYNC End - Low (Address 62h) (R/W)

It defines the low byte of Vertical SYNC end position in lines.

D7-0 DV_SYNC_END[7:0]

Display Vertical SYNC End - High (Address 63h) (R/W)

It defines the high byte of Vertical SYNC end position in lines.

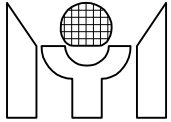

D7-3 Reserved

D2-0 DV_SYNC_END[10:8]

Note: Display Vertical SYNC Start is always equal 0.

Display Vertical Active Start - Low (Address 64h) (R/W)

It defines the low byte of Vertical Active region start position in lines.

D7-0 DV_ACT_START[7:0]

Display Vertical Active Start - High (Address 65h) (R/W)

It defines the high byte of Vertical Active region start position in lines.

D7-3 Reserved

D2-0 DV_ACT_START[10:8]

Display Vertical Active End - Low (Address 66h) (R/W)

It defines the low byte of Vertical Active region end position in lines.

D7-0 DV_ACT_END[7:0]

Display Vertical Active End - High (Address 67h) (R/W)

It defines the high byte of Vertical Active region end position in lines.

D7-3 Reserved

D2-0 DV_ACT_END[10:8]

Display Horizontal Total - Low (Address 70h) (R/W)

It defines the low byte of the number of display clock cycles per display line.

D7-0 DH_TOTAL[7:0]

Display Horizontal Total - High (Address 71h) (R/W)

It defines the high byte of the number of display clock cycles per display line.

D7-3 Reserved

D2-0 DH_TOTAL[10:8]

Display Horizontal SYNC End - Low (Address 72h) (R/W)

It defines the low byte of Horizontal SYNC end position in display clock cycles.

D7-0 DH_SYNC_END[7:0]

Display Horizontal SYNC End - High (Address 73h) (R/W)

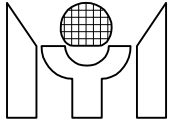

It defines the high byte of Horizontal SYNC end position in display clock cycles.

D7-3 Reserved

D2-0 DH_SYNC_END[10:8]

Note: Display Horizontal SYNC Start is always equal 0.

Display Horizontal Active Start - Low (Address 74h) (R/W)

It defines the low byte of Horizontal Active region start position in display clock cycles.

D7-0 DH_ACT_START[7:0]

Display Horizontal Active Start - High (Address 75h) (R/W)

It defines the high byte of Horizontal Active region start position in display clock cycles.

D7-3 Reserved

D2-0 DH_ACT_START[10:8]

Display Horizontal Active End - Low (Address 76h) (R/W)

It defines the low byte of Horizontal Active region end position in display clock cycles.

D7-0 DH_ACT_END[7:0]

Display Horizontal Active End - High (Address 77h) (R/W)

It defines the high byte of Horizontal Active region end position in display clock cycles.

D7-3 Reserved

D2-0 DH_ACT_END[10:8]

NFB Timing Control (Address 7Fh)

It defines the NFB timing setting and high byte of NFB Horizontal Counter load value.

D7 Free Running mode Select
0: Normal
1: Free Running

D6-4 NFB Synchronization mode
000: Delay mode. Output HSYNC trimmed in output VSYNC and VDE issued on next HSYNC when Lock event occurs.
010: Immediate mode. Output HSYNC trimmed immediately and VDE issued on next HSYNC when Lock event occurs.
110: Early mode. Output HSYNC trimmed immediately and VDE issued immediately when Lock event occurs.

D3-0 Reserved

Output Image Control Register 0 (Address 88h) (R/W)

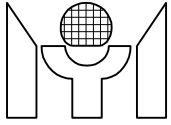

D7-5	Reserved
D4	OUTPUT port MSB / LSB change 0: No Exchange 1: Exchange
D3	Reserved
D2	Output Pixel 18 bit RGB Mode Select 0: 24 bit RGB 1: 18 bit RGB
D1	Output Dual Pixel Data Exchange 0: Normal 1: Exchange
D0	Output Dual Pixel Select 0: Dual Pixel 1: Single Pixel

Output Image Control Register 1 (Address 89h) (R/W)

D7-6	Reserved
D5	RGB Brightness Control Enable 0: Disable 1: Enable
D4	RGB Gain Control Enable 0: Disable 1: Enable
D3-1	Reserved
D0	Output Blank Screen 0: Normal 1: Output Pixel masked as BLACK color

Output Image Control Register 2 (Address 8Ah) (R/W)

D7	Reserved
D6	Temporal Dithering Enable 0: Static Dithering 1: Temporal Dithering
D5	Reserved
D4	Dithering Enable 0: Disable 1: Enable
D3	Color Gain Control Resolution Select 0: 8-bit Resolution 1: 9-bit Resolution

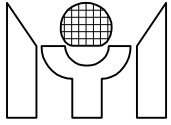

D2	Reserved
D1	Gamma Table R/W Access Enable 0: Disable 1: Enable
D0	Gamma Correction Function 0: OFF 1: ON

Color Gain Control - RED (Address 90h) (R/W)

It can be used to adjust the gain of RED component of the Display Image.

D7-0	RGAIN[7:0] 0(00h) ~ x1(80h) ~ x1.992185(FFh)
------	---

Color Gain Control - GREEN (Address 91h) (R/W)

It can be used to adjust the gain of GREEN component of the Display Image.

D7-0	GGAIN[7:0] 0(00h) ~ x1(80h) ~ x1.992185(FFh)
------	---

Color Gain Control - BLUE (Address 92h) (R/W)

It can be used to adjust the gain of BLUE component of the Display Image.

D7-0	BGAIN[7:0] 0(00h) ~ x1(80h) ~ x1.992185(FFh)
------	---

Color Brightness Control - RED (Address 93h) (R/W)

It can be used to adjust the brightness of RED component of the Display Image.

D7-0	RBRIGHT[7:0] -128(80h) ~ 0(00h) ~127(7Fh)
------	--

Color Brightness Control - GREEN (Address 94h) (R/W)

It can be used to adjust the brightness of GREEN component of the Display Image.

D7-0	GBRIGHT[7:0] -128(80h) ~ 0(00h) ~127(7Fh)
------	--

Color Brightness Control - BLUE (Address 95h) (R/W)

It can be used to adjust the brightness of BLUE component of the Display Image.

D7-0	BBRIGHT[7:0] -128(80h) ~ 0(00h) ~127(7Fh)
------	--

Gamma Table Data Port (Address 9Fh) (R/W)

Since the Gamma Table is downloadable, this data port is the entry address.

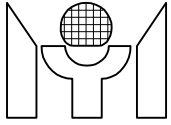

D7-0 GAMMA_PORT[7:0]

OSD Control Registers 0 (Address A0h) (R/W)

- D7 OSD Output Clock Select
0: from Internal Display Dot Clock
1: from Internal Display Dot Clock x 2
- D6 OSD Output VS Invert
0: Normal
1: Invert
- D5-4 Reserved
- D3 OSD Function
0: OFF
1: ON
- D2 Reserved
- D1-0 OSD TYPE Select
00: OSDRGB = {R0000000, G0000000, B0000000}
01: OSDRGB = {RR000000, GG000000, BB000000}
10: OSDRGB = {RRRR0000, GGGG0000, BBBB0000}
11: OSDRGB = {RRRRRRRR, GGGGGGGG, BBBBBBBB}
R = OSDR, G = OSDG, B = OSDB

OSD Control Register 1 (Address A1h) (R/W)

- D7 OSD Output HS Invert
0: Normal
1: Invert.
- D6 OSD Output DCLK Invert
0: Normal
1: Invert.
- D5-4 OSD Output HS Delay
4 steps to change, each of them is 1ns delay/step.
- D3 OSD Input Data Sample Clock Invert
0: Normal.
1: Invert.
- D2-0 OSD Input Data Sample Clock Delay
8 steps to change, each of them is 1ns delay/step.

OSD Control Register 2 (Address A2h) (R/W)

- D7-4 Reserved
- D3-0 OSD Output Clock Delay
16 steps to change, each of them is 1ns delay/step.

Output Invert Control (Address A4h) (R/W)

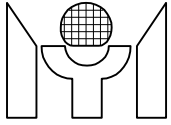

D7	Reserved
D6	RGB Data Invert Enable 0: Disable 1: Enable
D5	Display DCLKH Invert 0: Normal 1: Invert
D4	Display DCLK Invert 0: Normal 1: Invert
D3	Reserved
D2	Display Data Enable (DDEN) Invert 0: Normal 1: Invert
D1	Display VSYNC Invert 0: Normal 1: Invert
D0	Display HSYNC Invert 0: Normal 1: Invert

Output Tri_state Control (Address A5h) (R/W)

D7	Display Data R2OUT, G2OUT, B2OUT Output Disable 0: Normal 1: Tri_stated
D6	Display Data R1OUT, G1OUT, B1OUT Output Disable 0: Normal 1: Tri_stated
D5	Display DCLK2 Output Disable 0: Normal 1: Tri_stated
D4	Display DCLK1 Output Disable 0: Normal 1: Tri_stated
D3	OSD OCLK / OVSYNC / OHSYNC Output Disable 0: Normal 1: Tri_stated
D2	Display Data Enable (DDEN) Output Disable 0: Normal 1: Tri_stated
D1	Display VSYNC Output Disable 0: Normal

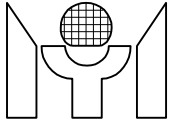

1: Tri_stated

D0 Display HSYNC Output Disable
0: Normal
1: Tri_stated

Output Clocks Delay Adjustment (Address A6h) (R/W)

D7-4 Display DCLKH delay adjustment
16 steps to adjust, Typical 1ns delay/step

D3-0 Display DCLK delay adjustment
16 steps to adjust, Typical 1ns delay/step

Output Clocks Duty Cycle Adjustment (Address A7h) (R/W)

D7 Display DCLKH duty cycle Increase/Decrease
0: Decrease
1: Increase

D6-4 Display DCLKH duty cycle adjustment
8 steps to adjust, Typical 0.5ns delay/step

D3 Display DCLK duty cycle Increase/Decrease
0: Decrease
1: Increase

D2-0 Display DCLK duty cycle adjustment
8 steps to adjust, Typical 0.5ns delay/step

Output Miscellaneous Control (Address A9h) (R/W)

D7 Second field Line Buffer Overflow status for Interlace input **(RO)**
0: Not Overflow
1: Overflow

D6 Second field Line Buffer Underflow status for Interlace input **(RO)**
0: Not Underflow
1: Underflow

D5 First field Line Buffer Overflow status for Interlace input or
Line buffer Overflow status for Non-interlace input **(RO)**
0: Not Overflow
1: Overflow

D4 First field Line Buffer Underflow status for Interlace input or
Line Buffer Overflow status for Non-interlace input **(RO)**
0: Not Underflow
1: Underflow

D3 Auto Output Horizontal Total Calculation Start **(W)**
0: Disable
1: Enable
Auto Output Horizontal Total Calculation Ready Flag **(R)**
0: Ready
1: Not Ready

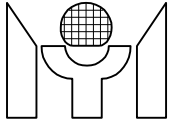

D2-0 Reserved

Output Vertical Active Line Number - Low (Address AAh) (R/W)

It defines the low byte of Output Vertical Active Line Number -1, only used for getting the values of Reg. ACh and ADh.

D7-0 OVDE[7:0]

Output Vertical Active Line Number - High (Address ABh) (R/W)

It defines the high byte of Output Vertical Active Line Number -1, only used for getting the values of Reg. ACh and ADh.

D1-0 OVDE[9:8]

Output Horizontal Total Pixel Number - Low (Address ACh) (RO)

It states the low byte of Output Horizontal Total Pixel Number.

D7-0 OHTOT[7:0]

Output Horizontal Total Pixel Number - High (Address ADh) (RO)

It states the high byte of Output Horizontal Total Pixel Number.

D2-0 OHTOT[10:8]

Output Horizontal Total Residue Number - Low (Address AEh) (RO)

It states the low byte of Output Horizontal Total Pixel Residue Number.

D7-0 OHTOT_RES[7:0]

Output Horizontal Total Residue Number - High (Address AFh) (RO)

It states the high byte of Output Horizontal Total Pixel Residue Number.

D7-2 Reserved

D1-0 OHTOT_RES[9:8]

Zoom Control Register 0 (Address B0h) (R/W)

D7 Reserved

D6-4 Vertical Scale Select
0xx: PASS mode
10x: DUPLICATE mode
110: BILINEAR mode
111: INTERPOLATION TABLE mode

D3 Reserved

D2-0 Horizontal Scale Select
0xx: PASS mode

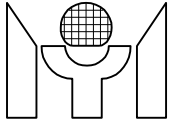

10x: DUPLICATE mode
110: BILINEAR mode
111: INTERPOLATION TABLE mode

Zoom Control Register 1 (Address B1h) (R/W)

D7-1 Reserved

D0 Interpolation Table R/W Access Enable
 0: Disable
 1: Enable

Zoom Vertical Scale Ratio – Low (Address B4h) (R/W)

It defines the low byte of vertical scale ratio value for scale up.

D7-0 ZVSF[7:0]

Zoom Vertical Scale Ratio - High (Address B5h) (R/W)

It defines the high byte of vertical scale ratio value for scale up.

D7-0 ZVSF[15:8]

$ZVSF = \text{CEIL}[(\text{input_height} - 1) / (\text{output_height} - 1) * 2^{16}]$

Zoom Horizontal Scale Ratio - Low (Address B6h) (R/W)

It defines the low byte of horizontal scale ratio value for scale up.

D7-0 ZHSF[7:0]

Zoom Horizontal Scale Ratio - High (Address B7h) (R/W)

It defines the high byte of horizontal scale ratio value for scale up.

D7-0 ZHSF[15:8]

$ZHSF = \text{CEIL}[(\text{input_width} - 1) / (\text{output_width} - 1) * 2^{16}]$

Interpolation Table Data Port (Address BFh) (R/W)

It defines the entry address of the Interpolation table data port.

D7-0 TFPORT[7:0]

Host Control Register 1 (Address C1h) (R/W)

D7 Reserved

D6 I2C Bus Address No Increment
 0: Normal
 1: No Increment

D5 Double Buffer load Select
 0: Immediately

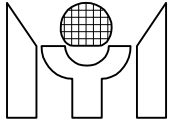

1: Delay to Display VSYNC

D4 Registers Double Buffer function Enable
0: Disable
1: Enable

D3-2 Reserved

D1 Display Registers Double Buffer Load **(WO)**

D0 Input Registers Double Buffer Load **(WO)**

Host Access Mode Status (Address CBh) (RO)

D7-1 Reserved

D0 Host Access Mode
0: 2-wire Serial mode (IIC)
1: 8-bit Parallel mode

Clock Synthesizer Control Register (Address E0h) (R/W)

D7 External Display Clock Selection
0: External Display Clock 1
1: External Display Clock 2

D6-3 Reserved

D2 Display Clock Source
0: Internal Display Clock
1: External Reference Clock

D1 Reserved

D0 Display Clock Synthesizer Enable
0: Enable
1: Disable

Clock Synthesizer Value Load (Address E1h) (WO)

D7-1 Reserved

D0 Display Clock Synthesizer Value Load **(WO)**

Display Clock Synthesizer N Value (Address E2h) (R/W)

D7-0 Display Clock Synthesizer N value

Display Clock Synthesizer M Value (Address E3h) (R/W)

D7-0 Display Clock Synthesizer M value

Clock Synthesizer R Value (Address E6h) (R/W)

D7-2 Reserved

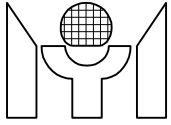

D1-0 Display Clock Synthesizer R value
 00: No divided
 01: Divided by 2
 1x: Divided by 4

SYNC Interrupt Flag Control (Address E8h) (R)

It contains the status of SYNC Interrupts.

D7 Display VSYNC Pulse Interrupt Status
 0: No Display VSYNC pulse detected
 1: Any Display VSYNC pulse detected

D6 Input VSYNC Pulse Interrupt Status
 0: No Input VSYNC pulse detected
 1: Any Input VSYNC pulse detected

D5 VSYNC Presence Change Status
 0: No Change
 1: Change

D4 HSYNC Presence Change Status
 0: No Change
 1: Change

D3 VSYNC Polarity Change Status
 0: No Change
 1: Change

D2 HSYNC Polarity Change Status
 0: No Change
 1: Change

D1 VSYNC Frequency Change Status
 0: No Change
 1: Change

D0 HSYNC Frequency Change Status
 0: No Change
 1: Change

SYNC Interrupt Flag Control (Address E8h) (W)

It is used to clear the corresponding SYNC interrupt signal when Software finishes serving the interrupt service routine.

D7 Clear Display VSYNC Pulse Interrupt Enable
 0: Disable
 1: Enable

D6 Clear Input VSYNC Pulse Interrupt Enable
 0: Disable
 1: Enable

D5 Clear VSYNC Presence Change Interrupt Enable
 0: Disable

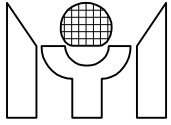

1: Enable

- D4 Clear HSYNC Presence Change Interrupt Enable
0: Disable
1: Enable
- D3 Clear VSYNC Polarity Change Interrupt Enable
0: Disable
1: Enable
- D2 Clear HSYNC Polarity Change Interrupt Enable
0: Disable
1: Enable
- D1 Clear VSYNC Frequency Change Interrupt Enable
0: Disable
1: Enable
- D0 Clear HSYNC Frequency Change Interrupt Enable
0: Disable
1: Enable

General Interrupt Flag Control (Address E9h) (R)

It contains the status of General Interrupts.

- D7-2 Reserved
- D1 Auto Position Finish Status (valid for Single mode only)
0: Not Finish
1: Finish
- D0 Auto Calibration Finish Status (valid for Single mode only)
0: Not Finish
1: Finish

General Interrupt Flag Control (Address E9h) (W)

It is used to clear the corresponding general interrupt signal when Software finishes serving the interrupt service routine.

- D7-2 Reserved
- D1 Clear Auto Position Finish Interrupt Enable
0: Disable
1: Enable
- D0 Clear Auto Calibration Finish Interrupt Enable
0: Disable
1: Enable

SYNC Interrupt Enable Control (Address EAh) (R/W)

It is used to enable SYNC Interrupt function.

- D7 Display VSYNC Pulse Interrupt Enable

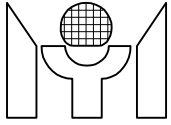

0: Disable
1: Enable

- D6 Input VSYNC Pulse Interrupt Enable
0: Disable
1: Enable
- D5 VSYNC Presence Change Interrupt Enable
0: Disable
1: Enable
- D4 HSYNC Presence Change Interrupt Enable
0: Disable
1: Enable
- D3 VSYNC Polarity Change Interrupt Enable
0: Disable
1: Enable
- D2 HSYNC Polarity Change Interrupt Enable
0: Disable
1: Enable
- D1 VSYNC Frequency Change Interrupt Enable
0: Disable
1: Enable
- D0 HSYNC Frequency Change Interrupt Enable
0: Disable
1: Enable

General Interrupt Enable Control (Address EBh) (R/W)

It is used to enable General Interrupt functions.

- D7 Interrupt Output Polarity
0: Active High
1: Active Low
- D6-2 Reserved
- D1 Auto Position Finish Interrupt Enable
0: Disable
1: Enable
- D0 Auto Calibration Finish Interrupt Enable
0: Disable
1: Enable

HS Frequency Change Interrupt Compare (Address ECh) (R/W)

It is used to control Interrupt generation by comparing the frequency change value when Input HS Frequency Changes.

- D7-0 HSCMPREG[7:0]

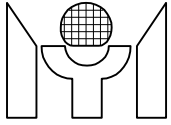

Power Management Control (Address F1h) (R/W)

D7	Reserved
D6	Power Down Gamma & Interpolation Table 0: Normal 1: Power Down
D5	Reserved
D4	Power Down Line Buffers 0: Normal 1: Power Down
D3	Reserved
D2	Mask REFCLK 0: Disable 1: Enable
D1	Power Down all the clocks except REFCLK 0: Normal 1: Power Down
D0	Software Reset Enable 0: Disable 1: Enable

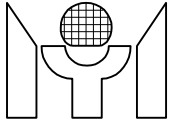

5. ELECTRICAL CHARACTERISTICS

5.1 DC CHARACTERISTICS

Table 5.1 Recommended Operating Conditions

SYMBOL	PARAMETER	MIN	TYP	MAX	UNIT
Vcc	Operation Voltage	3.0	3.3	3.6	V
Tamb	Operating Ambient Temperature	0		70	°C
Tstg	Storage Temperature	-55		150	°C

Table 5.2 DC Electrical Characteristics for 3.3 V Operation

SYMBOL	PARAMETER	CONDITIONS	MIN	TYP	MAX	UNIT
VIL	Input Low Voltage				0.8	V
VIH	Input High Voltage		2.0			V
Vt-	Input Schmitt Trigger Low Voltage at pins SDA and SCK			1.0		
Vt+	Input Schmitt Trigger High Voltage at pins SDA and SCK			1.7		
VOL	Output Low Voltage				0.4	V
VOH	Output High Voltage		2.4			V
RI	Input Pull-up/Down Resistance	VIL = 0v or VIH = VCC		75		Kohm
ILI	Input Leakage Current		-10		10	uA
ILO	Output Leakage Current		-20		20	uA

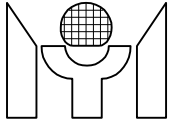

5.2 AC CHARACTERISTICS

□ Input Interface Timing

Figure 5.2.1 Input Interface Timing

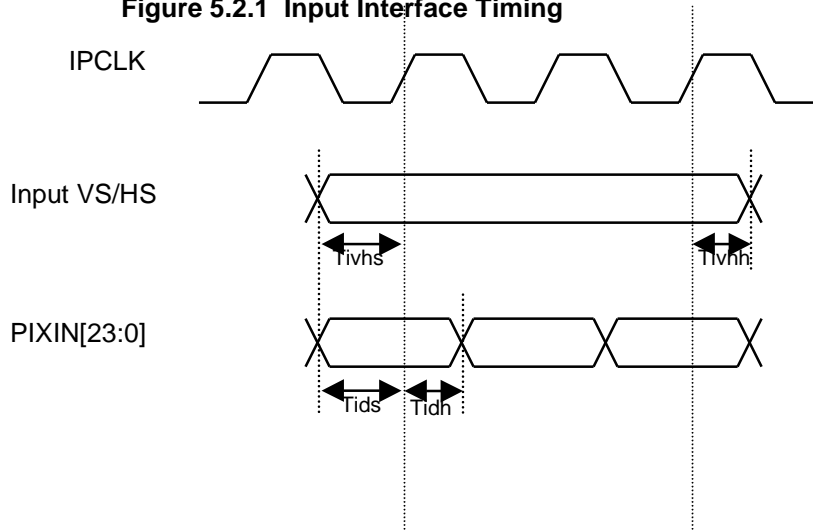
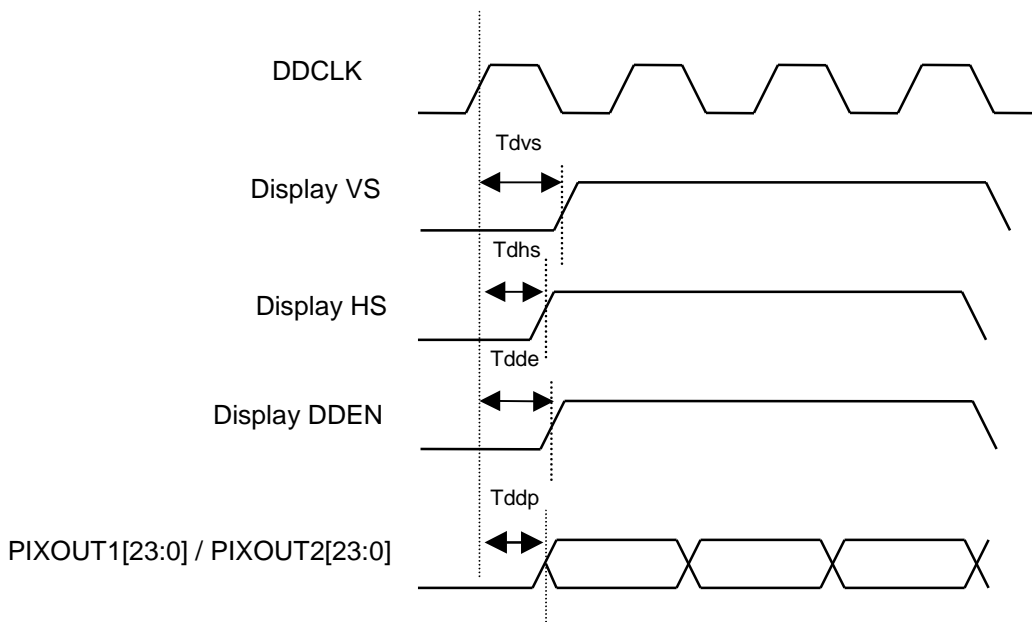

Table 5.2.1 Input Interface Timing

SYMBOL	PARAMETER	MIN	MAX	UNIT
T_{ids}	Input Image Signal Setup Time for IPCLK	2		ns
T_{idh}	Input Image Signal Hold Time for IPCLK	3		ns
T_{ivhs}	Input VSYNC/HSYNC Setup Time for IPCLK	2		ns
T_{ivhh}	Input VSYNC/HSYNC Hold Time for IPCLK	3		ns

□ Output Interface Timing

Figure 5.2.2 Output Interface Timing



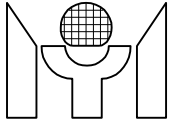

Table 5.2.2 Output Interface Timing

SYMBOL	PARAMETER	MIN	MAX	UNIT
Tdvs	Display VSYNC Output Delay to DDCLK	2		ns
Tdhs	Display HSYNC Output Delay to DDCLK	0.5		ns
Tdde	Display DDEN Output Delay to DDCLK	1		ns
Tddp	Display Data Output Delay to DDCLK	1.5		ns

Note: DDCLK phase can be adjusted relative to data and control outputs using the DDCLK_INV (Reg. A4h/D5-4) and DDCLK_DELAY[2:0] (Reg. A6h/D7-0) programming controls.

□ **OSD Interface Timing**

Figure 5.2.3 OSD Interface Timing

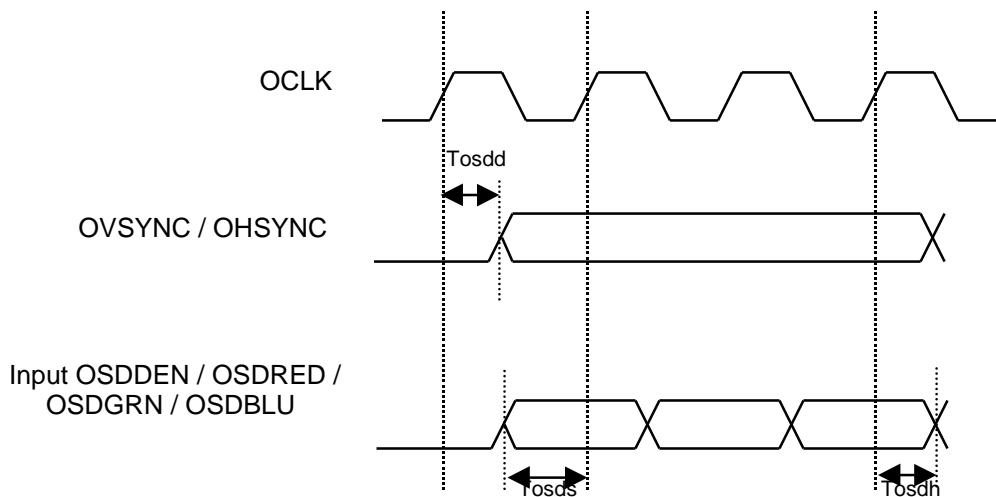
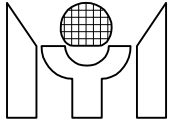

Table 5.2.3 OSD Interface Timing

SYMBOL	PARAMETER	MIN	MAX	UNIT
Tosdd	OSD VS / HS Output Delay to OCLK	2		ns
Tosds	OSD Signal Input Setup Time for OCLK	5.5		ns
Tosdh	OSD Signal Input Hold Time for OCLK	0		ns

Note: OCLK phase can be adjusted using OCLK_INV (Reg. A1h/D3) programming control and OHSYNC phase can be adjusted using OHSYNC_DELAY[1:0] (Reg. A1h/D5-4) programming control.



□ I2C Host Interface Timing

Figure 5.2.4 I2C Host Interface Timing

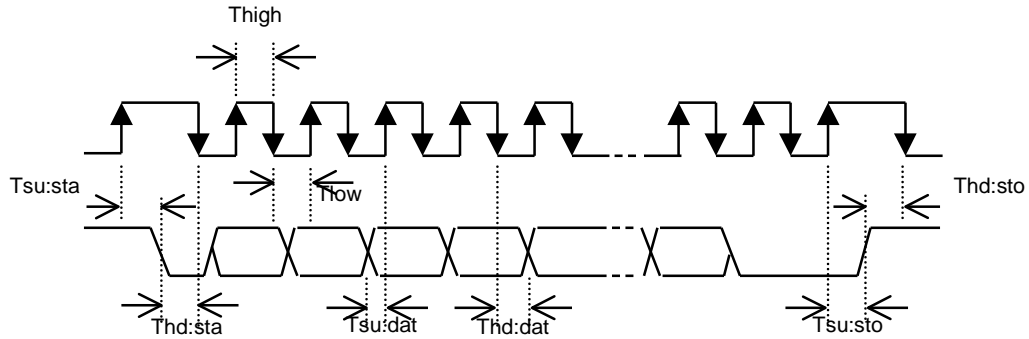
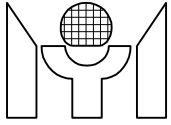

Table 5.2.4 I2C Host Interface Timing

SYMBOL	PARAMETER	MIN	MAX	UNIT
T_{high}	Clock High Period	500		ns
T_{low}	Clock Low Period	500		ns
$T_{su:dat}$	Data in Setup Time	200		ns
$T_{hd:dat}$	Data in Hold Time	100		ns
$T_{su:sta}$	Start condition Setup Time	500		ns
$T_{hd:sta}$	Start condition Hold Time	500		ns
$T_{su:sto}$	Stop condition Setup Time	500		ns
$T_{hd:sto}$	Stop condition Hold Time	500		ns



6. PACKAGE DIMENSION

128 QFP

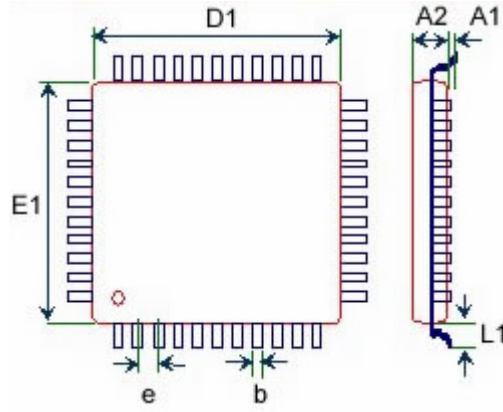

A1	stand-off
A2	body thickness
L1	lead length
b	lead width
c	lead thickness
e	lead pitch

(All units are in mm)

body size		lead count	A1	A2	L1	b	c	e
D1	E1							
14	20	128	0.25	2.72	1.6	0.2	0.15	0.5