



# DL100-22HA2102

Dx100

**LONG RANGE DISTANCE SENSORS**

**SICK**  
Sensor Intelligence.



Illustration may differ



## Ordering information

Type	Part no.
DL100-22HA2102	1052693

Other models and accessories → [www.sick.com/Dx100](http://www.sick.com/Dx100)

## Detailed technical data

### Performance

<b>Measuring range</b>	0.15 m ... 200 m, on reflective tape "Diamond Grade"
<b>Resolution</b>	0.1 mm, 0.125 mm, 1 mm, 10 mm, 100 mm
<b>Repeatability</b>	1 mm <sup>1)</sup>
<b>Accuracy</b>	± 2.5 mm <sup>2)</sup>
<b>Dead time</b>	2 ms
<b>Output time</b>	Synchronous to PLC request (dependent on interfaces)
<b>Light source</b>	Laser, red <sup>3)</sup>
<b>Laser class</b>	2 (EN 60825-1 / CDRH)
<b>Typ. light spot size (distance)</b>	5 mm (+ 2 mm x distance in m)
<b>Max. movement speed</b>	30 m/s
<b>Acceleration (max.)</b>	≤ 15 m/s <sup>2</sup>
<b>Internal measurement cycle</b>	1 ms
<b>Heating</b>	✓

<sup>1)</sup> Statistical error 1  $\sigma$ , environmental conditions constant, min. warm-up time 10 min.

<sup>2)</sup> From 150 mm ... 180 mm measuring range the accuracy can reach ± 4 mm.

<sup>3)</sup> Average service life: 100,000 h at T<sub>U</sub> = +25 °C.

### Interfaces

<b>Switching output</b>	B (push/pull), MF1, MF2 <sup>1)</sup>
<b>Multifunctional input (MF)</b>	1 x MF1 <sup>2)</sup>
<b>Data interface</b>	PROFIBUS DP

<sup>1)</sup> HIGH > V<sub>S</sub> - 3 V / LOW < 2 V.

<sup>2)</sup> HIGH > 12 V / LOW < 3 V.

## Mechanics/electronics

<b>Supply voltage <math>V_s</math></b>	DC 18 V ... 30 V, limit values
<b>Ripple</b>	5 V <sub>pp</sub> <sup>1)</sup>
<b>Initialization time</b>	Typ. 1.5 s <sup>2)</sup>
<b>Housing material</b>	Aluminum/zinc die-cast
<b>Connection type</b>	Male connector, M12, SPEEDCON™ compatible
<b>Indication</b>	6 digit 5 x 7 dot matrix display, LEDs
<b>Weight</b>	Approx. 800 g ... 1,600 g <sup>3)</sup>
<b>Output current <math>I_A</math></b>	≤ 100 mA <sup>4)</sup>
<b>Current consumption</b>	At 24 V DC < 1,000 mA
<b>Modulation frequency</b>	Fix

<sup>1)</sup> May not fall short of or exceed  $V_s$  tolerances.

<sup>2)</sup> After loss of reflector < 40 ms.

<sup>3)</sup> Without mounting bracket: approx. 800 g, with mounting bracket: approx. 1,600 g.

<sup>4)</sup> Short-circuit protected, overload-protected. Max. 100 nF / 20 mH.

## Ambient data

<b>Enclosure rating</b>	IP 65
<b>Protection class</b>	III
<b>Electromagnetic compatibility (EMC)</b>	EN 61000-6-2, EN 61000-6-4 <sup>1)</sup>
<b>Ambient temperature</b>	Operation with heating: -40 °C ... +55 °C Operation with cooling case: -40 °C ... +75 °C Storage: -40 °C ... +75 °C
<b>Effect of air pressure</b>	0.3 ppm/hPa
<b>Effect of air temperature</b>	1 ppm/K
<b>Temperature drift</b>	Typ. 0.1 mm/K
<b>Mechanical load</b>	Shock: (EN 600 68-2-27) Sine: (EN 600 68-2-6) Noise: (EN 600 68-2-64)

<sup>1)</sup> This is a Class A device. This device can cause radio interference in living quarters.

# DL100-22HA2102 | Dx100

## LONG RANGE DISTANCE SENSORS

### Dimensional drawing (Dimensions in mm (inch))

Dimensional drawing

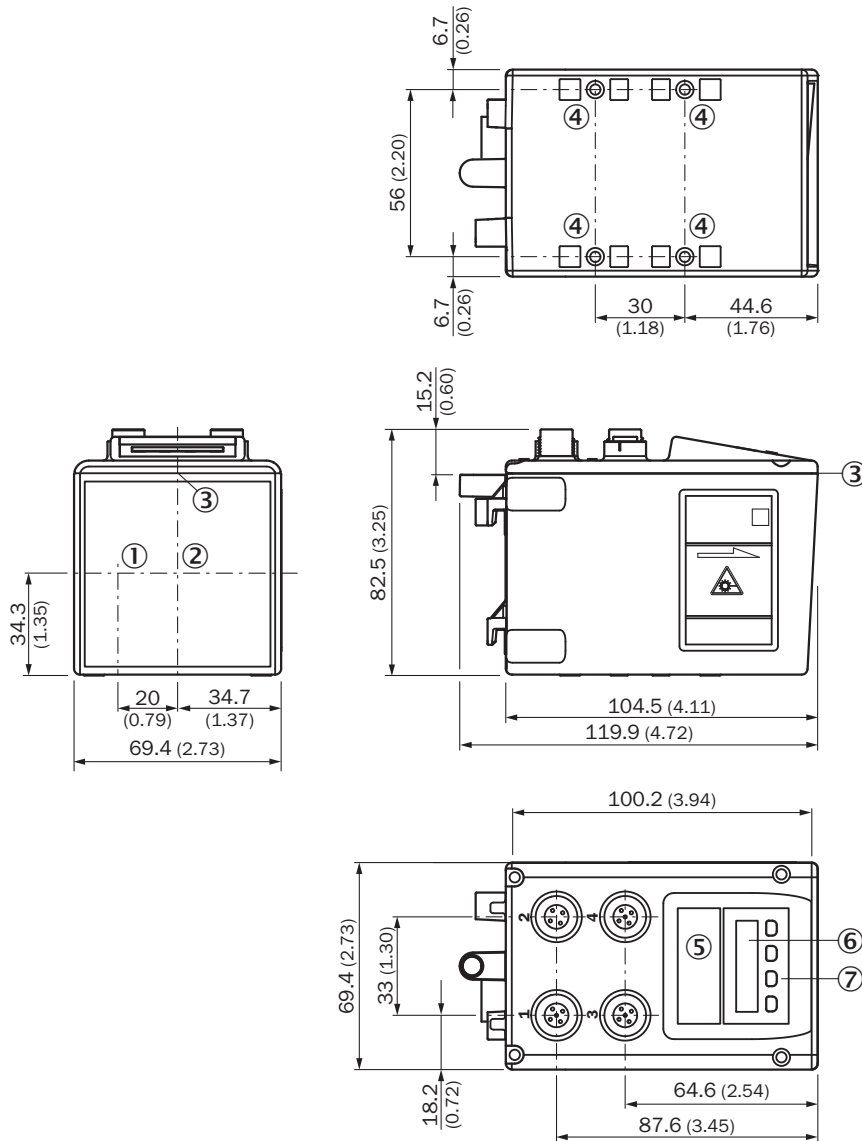

- ① Optical axis, sender
- ② Optical axis, receiver
- ③ Zero level
- ④ Threaded mounting hole M5
- ⑤ Status LED [status]
- ⑥ Display
- ⑦ Operating elements

### Connection type

DL100 Pro PROFIBUS IN, M12 male connector, 5-pin, B-coded

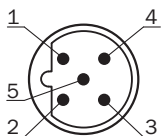

DL100 Pro PROFIBUS OUT, M12 female connector, 5-pin, B-coded

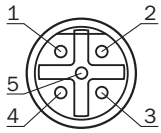

Dx100 PROFIBUS/PROFINET/CANopen/Ethernet/IP, M12 male connector, 4-pin, A-coded

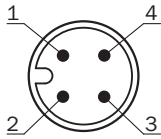

### Connection diagram

DL100 Pro PROFIBUS OUT, M12 female connector, 5-pin, B-coded

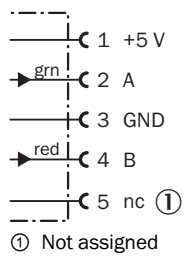

Dx100 PROFIBUS/PROFINET, M12 male connector, 4-pin

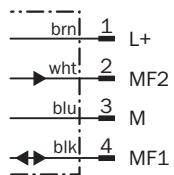

Ethernet M12 female connector, 4-pin

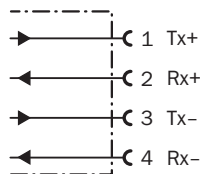

## Adjustment possible

DL100-xxXXxx02

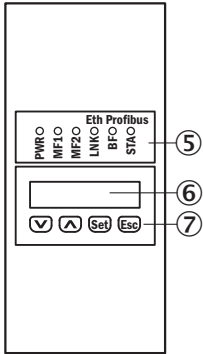



- ⑤ Status LED [status]
- ⑥ Display
- ⑦ Operating elements

## Recommended accessories

Other models and accessories → [www.sick.com/Dx100](http://www.sick.com/Dx100)

	Brief description	Type	Part no.
<b>Terminal and alignment brackets</b>			
	Alignment unit for Dx100, incl. mounting material, steel, zinc coated	BEF-AH-DX100	2058653
<b>Plug connectors and cables</b>			
	Head A: female connector, M12, 4-pin, straight Head B: cable Cable: PVC, unshielded, 5 m	DOL-1204-G05M	6009866
	Head A: female connector, M12, 5-pin, straight Head B: cable Cable: PROFIBUS DP, PVC, shielded, 10 m	DOL-1205-G10MQ	6026008
	Head A: male connector, M12, 5-pin, straight, B-coded Head B: cable Cable: PROFIBUS DP, drag chain use, PUR, halogen-free, shielded, 10 m Wire shield Al-Pt film, overall shield C-screen tin-plated	STL-1205-G10MQ	6026007
	Head A: male connector, M12, 4-pin, straight, D-coded Head B: male connector, RJ45, 8-pin, straight Cable: PROFINET, drag chain use, PUR, shielded, 5 m CAT 5e	SSL-2J04-G05ME	6035389
	Head A: male connector, M12, 4-pin, straight, B-coded Cable: PROFIBUS DP, terminal resistor	STE-END-Q	6021156
<b>Reflectors</b>			
	Reflector plate, reflective tape "Diamond Grade", 665 mm x 665 mm, material base plate: aluminum, screw connection, Screw-on, 4 hole mounting	PL560DG	1016806
<b>Sets and kits</b>			

	Brief description	Type	Part no.
	Accessory kit for upgrade from DME3000 PROFIBUS to Dx100 PROFIBUS	DME3000 Dx100 PROFIBUS upgrade kit	2065222
	Accessory kit for upgrade from DME4000/5000 PROFIBUS to Dx100 PROFIBUS	DME4000/5000 Dx100 PROFIBUS upgrade kit	2065220

## SICK AT A GLANCE

SICK is one of the leading manufacturers of intelligent sensors and sensor solutions for industrial applications. A unique range of products and services creates the perfect basis for controlling processes securely and efficiently, protecting individuals from accidents and preventing damage to the environment.

We have extensive experience in a wide range of industries and understand their processes and requirements. With intelligent sensors, we can deliver exactly what our customers need. In application centers in Europe, Asia and North America, system solutions are tested and optimized in accordance with customer specifications. All this makes us a reliable supplier and development partner.

Comprehensive services complete our offering: SICK LifeTime Services provide support throughout the machine life cycle and ensure safety and productivity.

For us, that is “Sensor Intelligence.”

## WORLDWIDE PRESENCE:

Contacts and other locations –[www.sick.com](http://www.sick.com)