

PANEL CUTOUT
MAX. PANEL THICKNESS 12mm

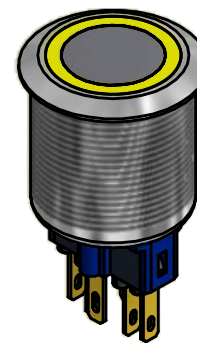

SWITCH FUNCTION	
POS. 1	POS. 2
1-2	3-4

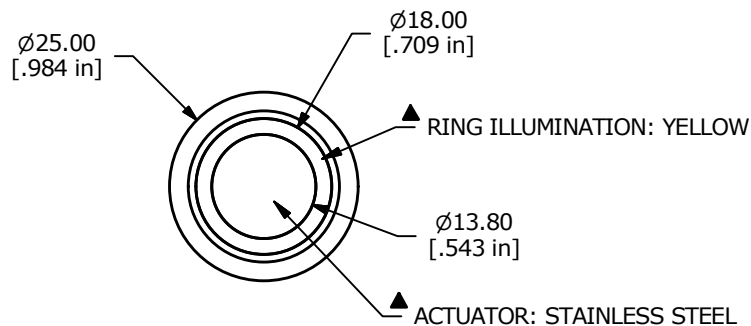
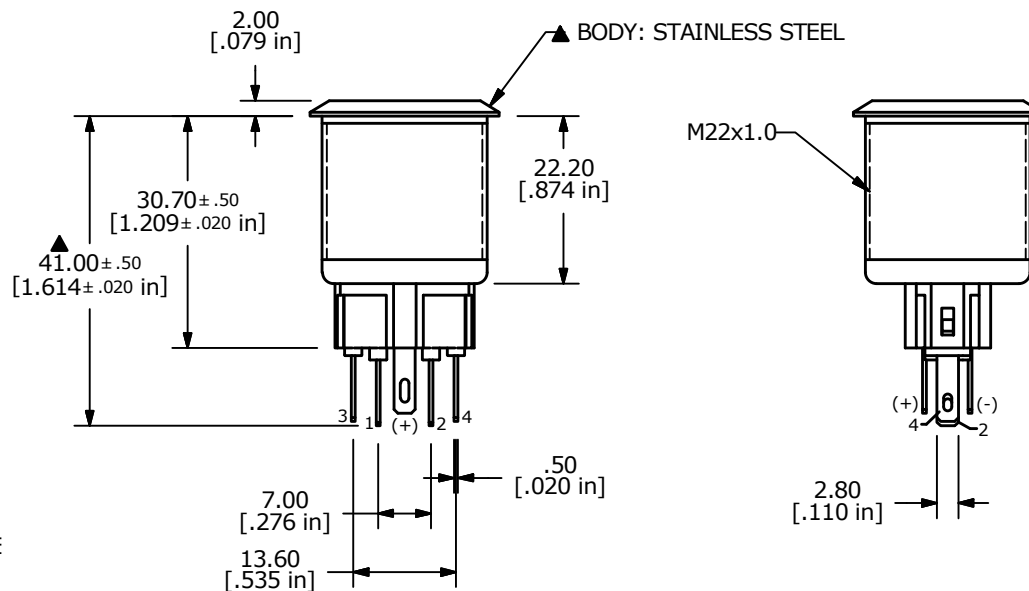
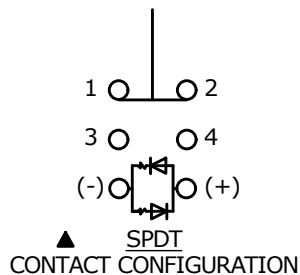

- NOTE:
- ALL DIMENSIONS IN MM [INCH]
 - GENERAL TOLERANCE: X.X = ± 0.4
X.XX = ± 0.25
 - TERMINAL NOS. FOR REF. ONLY
 - FUNCTION: SPDT
 - RATING: 2A @ 48VDC
 - ILLUMINATION VOLTAGE: 20mA 1.8V
 - CONTACT RESISTANCE: 50mΩ MAX. @ 1A 12VDC
 - INSULATION RESISTANCE: 1,000MΩ @ 500VDC
 - DIELECTRIC STRENGTH: 2,000VAC MIN. FOR 1 MINUTE
 - ELECTRICAL LIFE: 50,000 CYCLES
 - OPERATING TEMPERATURE: -20°C TO 70°C
 - INGRESS PROTECTION: IP65
 - ▲ DENOTES CRITICAL PARAMETER
 - 2002/95/EC (ROHS) COMPLIANT
 - ILLUMINATION COLOR: YELLOW (FORWARD), YELLOW (REVERSE)
 - SUPPLIED HARDWARE: O-RING AND HEX NUT



TITLE PV7F2T0SS-351				
SCALE 1:1	DATE 4/15/2015	DR MW	DWG 52-PV7F2T0SS351	REV A

A	21830	RELEASE FOR PRODUCTION	4/15/15	MW
REV	PCR NO	DESCRIPTION	DATE	BY

THE INFORMATION CONTAINED IN THIS DOCUMENT IS PROPRIETARY TO E-SWITCH AND IS NOT TO BE COPIED OR TRANSFERRED