

Dual IGBTMOD™ NFH-Series Module 100 Amperes/1200 Volts

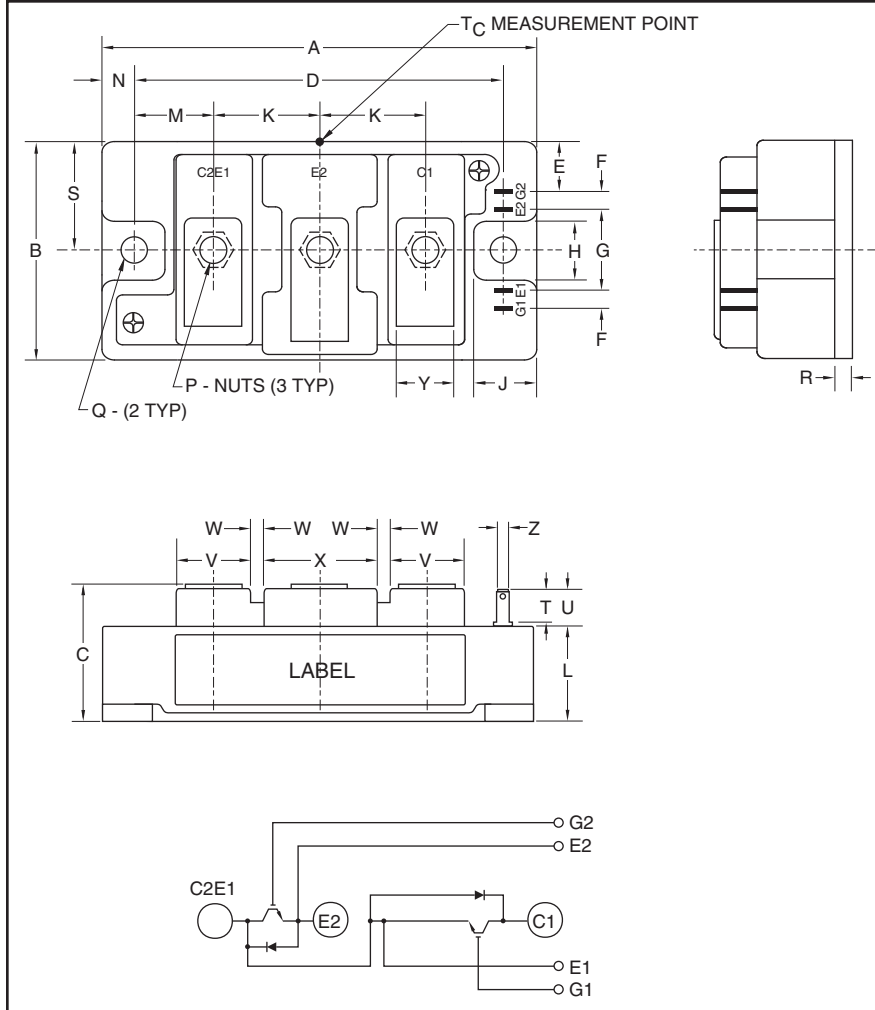

Outline Drawing and Circuit Diagram

Dimensions	Inches	Millimeters
A	3.70	94.0
B	1.89	48.0
C	1.18+0.04/-0.01	30.0+1.0/-0.5
D	3.15±0.01	80.0±0.25
E	0.43	11.0
F	0.16	4.0
G	0.71	18.0
H	0.51	13.0
J	0.53	13.5
K	0.91	23.0
L	0.83	21.2
M	0.67	17.0

Dimensions	Inches	Millimeters
N	0.28	7.0
P	M5 Metric	M5
Q	0.26 Dia.	Dia. 6.5
R	0.02	4.0
S	0.94	24.0
T	0.3	7.5
U	0.33	8.5
V	0.63	16.0
W	0.1	2.5
X	0.98	25.0
Y	0.47	12.0
Z	0.11	2.8

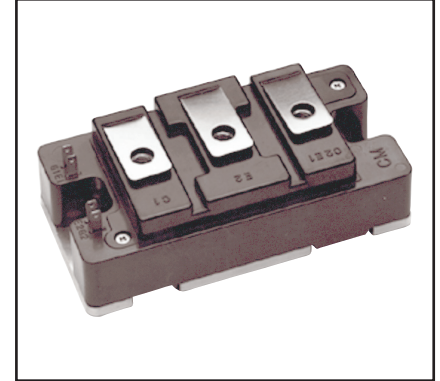

Description:

Powerex IGBTMOD™ Modules are designed for use in high frequency applications; 30 kHz for hard switching applications and 60 to 70 kHz for soft switching applications. Each module consists of two IGBT Transistors in a half-bridge configuration with each transistor having a reverse-connected super-fast recovery free-wheel diode. All components and interconnects are isolated from the heat sinking baseplate, offering simplified system assembly and thermal management.

Features:

- Low ESW(off)
- Discrete Super-Fast Recovery Free-Wheel Diode
- Isolated Baseplate for Easy Heat Sinking

Applications:

- Power Supplies
- Induction Heating
- Welders

Ordering Information:

Example: Select the complete part module number you desire from the table below -i.e. CM100DU-24NFH is a 1200V (V_{CEs}), 100 Ampere Dual IGBTMOD™ Power Module.

Type	Current Rating Amperes	V _{CEs} Volts (x 50)
CM	100	24



Powerex, Inc., 173 Pavilion Lane, Youngwood, Pennsylvania 15697 (724) 925-7272

CM100DU-24NFH
Dual IGBTMOD™ NFH-Series Module
 100 Amperes/1200 Volts

Absolute Maximum Ratings, $T_j = 25\text{ }^\circ\text{C}$ unless otherwise specified

Ratings	Symbol	CM100DU-24NFH	Units
Junction Temperature	T_j	-40 to 150	$^\circ\text{C}$
Storage Temperature	T_{stg}	-40 to 125	$^\circ\text{C}$
Collector-Emitter Voltage (G-E Short)	V_{CES}	1200	Volts
Gate-Emitter Voltage (C-E Short)	V_{GES}	± 20	Volts
Collector Current ($T_C = 25^\circ\text{C}$)	I_C	100*	Amperes
Peak Collector Current	I_{CM}	200*	Amperes
Emitter Current** ($T_C = 25^\circ\text{C}$)	I_E	100*	Amperes
Peak Emitter Current**	I_{EM}	200*	Amperes
Maximum Collector Dissipation ($T_C = 25^\circ\text{C}, T_j \leq 150^\circ\text{C}$)	P_C	560	Watts
Maximum Collector Dissipation ($T_C = 25^\circ\text{C}, T_j \leq 150^\circ\text{C}$)	P_C	730	Watts
Mounting Torque, M5 Main Terminal	—	30	in-lb
Mounting Torque, M6 Mounting	—	40	in-lb
Weight	—	310	Grams
Isolation Voltage (Main Terminal to Baseplate, AC 1 min.)	V_{ISO}	2500	Volts

Static Electrical Characteristics, $T_j = 25\text{ }^\circ\text{C}$ unless otherwise specified

Characteristics	Symbol	Test Conditions	Min.	Typ.	Max.	Units
Collector-Cutoff Current	I_{CES}	$V_{CE} = V_{CES}, V_{GE} = 0V$	—	—	1.0	mA
Gate Leakage Current	I_{GES}	$V_{GE} = V_{GES}, V_{CE} = 0V$	—	—	0.5	μA
Gate-Emitter Threshold Voltage	$V_{GE(th)}$	$I_C = 10\text{mA}, V_{CE} = 10V$	4.5	6.0	7.5	Volts
Collector-Emitter Saturation Voltage	$V_{CE(sat)}$	$I_C = 100\text{A}, V_{GE} = 15V, T_j = 25^\circ\text{C}$	—	5.0	6.5	Volts
		$I_C = 100\text{A}, V_{GE} = 15V, T_j = 125^\circ\text{C}$	—	5.0	—	Volts
Total Gate Charge	Q_G	$V_{CC} = 600V, I_C = 100\text{A}, V_{GE} = 15V$	—	450	—	nC
Emitter-Collector Voltage**	V_{EC}	$I_E = 100\text{A}, V_{GE} = 0V$	—	—	3.5	Volts

Dynamic Electrical Characteristics, $T_j = 25\text{ }^\circ\text{C}$ unless otherwise specified

Characteristics	Symbol	Test Conditions	Min.	Typ.	Max.	Units
Input Capacitance	C_{ies}		—	—	16	nf
Output Capacitance	C_{oes}	$V_{CE} = 10V, V_{GE} = 0V$	—	—	1.3	nf
Reverse Transfer Capacitance	C_{res}		—	—	0.3	nf
Inductive Load	Turn-on Delay Time	$V_{CC} = 600V, I_C = 100\text{A},$ $V_{GE1} = V_{GE2} = 15V, R_G = 3.1\Omega,$	—	—	100	ns
	Rise Time					
Switch Time	Turn-off Delay Time	Inductive Load Switching Operation,	—	—	250	ns
	Fall Time					
Diode Reverse Recovery Time**	t_{rr}	$I_E = 100\text{A}$	—	—	150	ns
Diode Reverse Recovery Charge**	Q_{rr}		—	5.0	—	μC

* Pulse width and repetition rate should be such that device junction temperature (T_j) does not exceed $T_{j(max)}$ rating.

**Represents characteristics of the anti-parallel, emitter-to-collector free-wheel diode (FWDi).

CM100DU-24NFH
Dual IGBTMOD™ NFH-Series Module
 100 Amperes/1200 Volts

Thermal and Mechanical Characteristics, $T_j = 25^\circ\text{C}$ unless otherwise specified

Characteristics	Symbol	Test Conditions	Min.	Typ.	Max.	Units
Thermal Resistance, Junction to Case	$R_{th(j-c)Q}$	Per IGBT 1/2 Module, T_C Reference Point per Outline Drawing	—	—	0.22	$^\circ\text{C/W}$
Thermal Resistance, Junction to Case	$R_{th(j-c)D}$	Per FWDi 1/2 Module, T_C Reference Point per Outline Drawing	—	—	0.47	$^\circ\text{C/W}$
Thermal Resistance, Junction to Case	$R_{th(j-c)'Q}$	Per IGBT 1/2 Module, T_C Reference Point Under Chips	—	—	0.17	$^\circ\text{C/W}$
Thermal Resistance, Junction to Case	$R_{th(j-c)'D}$	Per FWDi 1/2 Module, T_C Reference Point per Outline Drawing	—	—	0.29	$^\circ\text{C/W}$
Contact Thermal Resistance	$R_{th(c-f)}$	Per 1/2 Module, Thermal Grease Applied	—	0.07	—	$^\circ\text{C/W}$
External Gate Resistance	R_G		3.1	—	31	Ω

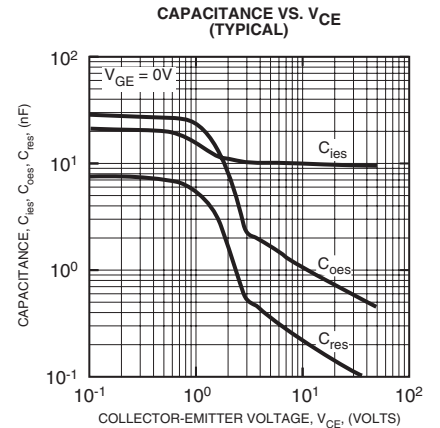
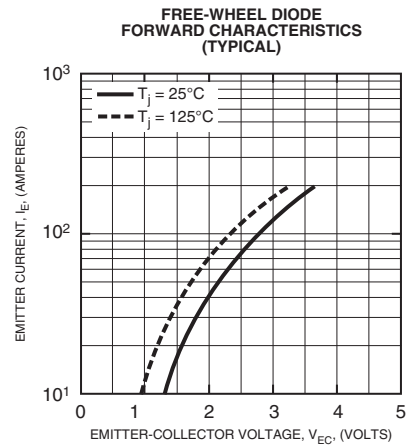
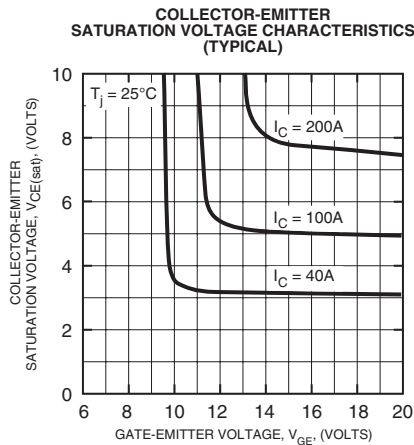
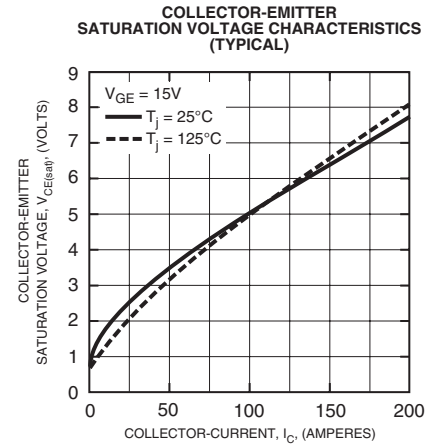
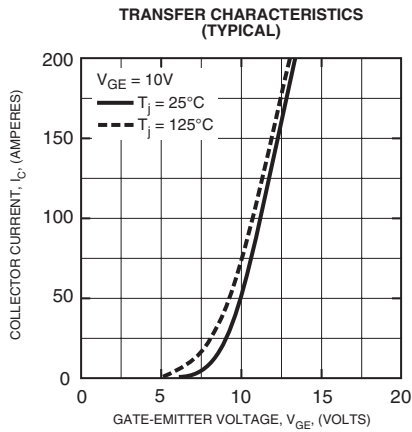
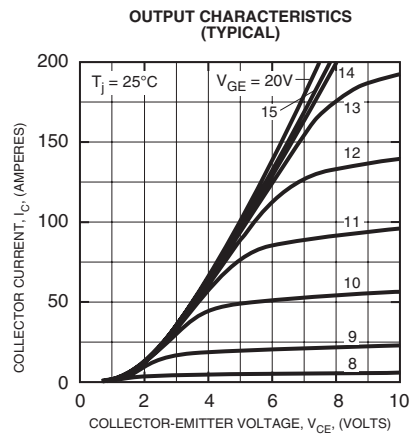



Powerex, Inc., 173 Pavilion Lane, Youngwood, Pennsylvania 15697 (724) 925-7272

CM100DU-24NFH
Dual IGBTMOD™ NFH-Series Module
 100 Amperes/1200 Volts

