

IGBT SIP MODULE

UltraFast IGBT

Features

- Fully isolated printed circuit board mount package
- Switching-loss rating includes all "tail" losses
- HEXFRED™ soft ultrafast diodes
- Optimized for high operating frequency (over 5kHz)
See Fig. 1 for Current vs. Frequency curve

Product Summary

Output Current in a Typical 20 kHz Motor Drive

4.6 A_{RMS} per phase (1.3 kW total) with T_C = 90°C, T_J = 125°C, Supply Voltage 360Vdc,
Power Factor 0.8, Modulation Depth 115% (See Figure 1)

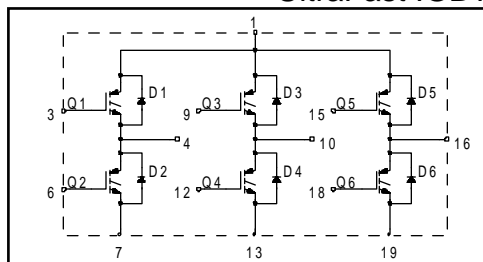

Description

The IGBT technology is the key to International Rectifier's advanced line of IMS (Insulated Metal Substrate) Power Modules. These modules are more efficient than comparable bipolar transistor modules, while at the same time having the simpler gate-drive requirements of the familiar power MOSFET. This superior technology has now been coupled to a state of the art materials system that maximizes power throughput with low thermal resistance. This package is highly suited to motor drive applications and where space is at a premium.

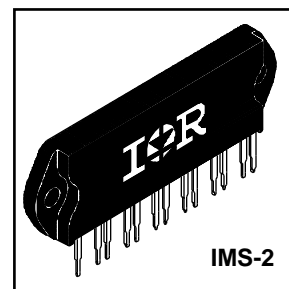

Absolute Maximum Ratings

	Parameter	Max.	Units
V _{CES}	Collector-to-Emitter Voltage	600	V
I _C @ T _C = 25°C	Continuous Collector Current, each IGBT	7.2	A
I _C @ T _C = 100°C	Continuous Collector Current, each IGBT	3.9	
I _{CM}	Pulsed Collector Current ①	22	
I _{LM}	Clamped Inductive Load Current ②	22	
I _F @ T _C = 100°C	Diode Continuous Forward Current	3.4	
I _{FM}	Diode Maximum Forward Current	22	
V _{GE}	Gate-to-Emitter Voltage	±20	V
V _{ISOL}	Isolation Voltage, any terminal to case, 1 minute	2500	V _{RMS}
P _D @ T _C = 25°C	Maximum Power Dissipation, each IGBT	23	W
P _D @ T _C = 100°C	Maximum Power Dissipation, each IGBT	9.1	
T _J	Operating Junction and Storage Temperature Range	-40 to +150	°C
T _{STG}			
	Mounting torque, 6-32 or M3 screw.	5-7 lbf•in (0.55-0.8 N•m)	

Thermal Resistance

	Parameter	Typ.	Max.	Units
R _{θJC} (IGBT)	Junction-to-Case, each IGBT, one IGBT in conduction	—	5.5	°C/W
R _{θJC} (DIODE)	Junction-to-Case, each diode, one diode in conduction	—	9.0	
R _{θCS} (MODULE)	Case-to-Sink, flat, greased surface	0.10	—	
Wt	Weight of module	20 (0.7)	—	g (oz)

Electrical Characteristics @ T_J = 25°C (unless otherwise specified)

	Parameter	Min.	Typ.	Max.	Units	Conditions
V _{(BR)CES}	Collector-to-Emitter Breakdown Voltage ^③	600	—	—	V	V _{GE} = 0V, I _C = 250μA
ΔV _{(BR)CES/ΔT_J}	Temperature Coeff. of Breakdown Voltage	—	0.63	—	V/°C	V _{GE} = 0V, I _C = 1.0mA
V _{CE(on)}	Collector-to-Emitter Saturation Voltage	—	1.70	2.2	V	I _C = 3.9A V _{GE} = 15V
		—	1.95	—		I _C = 7.2A
		—	1.70	—		I _C = 3.9A, T _J = 150°C
V _{GE(th)}	Gate Threshold Voltage	3.0	—	6.0		V _{CE} = V _{GE} , I _C = 250μA
ΔV _{GE(th)/ΔT_J}	Temperature Coeff. of Threshold Voltage	—	-11	—	mV/°C	V _{CE} = V _{GE} , I _C = 250μA
g _{fe}	Forward Transconductance ^④	1.4	4.3	—	S	V _{CE} = 100V, I _C = 6.5A
I _{CES}	Zero Gate Voltage Collector Current	—	—	250	μA	V _{GE} = 0V, V _{CE} = 600V
		—	—	2500		V _{GE} = 0V, V _{CE} = 600V, T _J = 150°C
V _{FM}	Diode Forward Voltage Drop	—	1.4	1.7	V	I _C = 8.0A See Fig. 13
		—	1.3	1.6		I _C = 8.0A, T _J = 150°C
I _{GES}	Gate-to-Emitter Leakage Current	—	—	±100	nA	V _{GE} = ±20V

Switching Characteristics @ T_J = 25°C (unless otherwise specified)

	Parameter	Min.	Typ.	Max.	Units	Conditions
Q _g	Total Gate Charge (turn-on)	—	31	47	nC	I _C = 3.9A
Q _{ge}	Gate - Emitter Charge (turn-on)	—	5.0	7.5		V _{CC} = 400V
Q _{gc}	Gate - Collector Charge (turn-on)	—	13	20		V _{GE} = 15V
t _{d(on)}	Turn-On Delay Time	—	45	—	ns	T _J = 25°C
t _r	Rise Time	—	22	—		I _C = 3.9A, V _{CC} = 480V
t _{d(off)}	Turn-Off Delay Time	—	100	160		V _{GE} = 15V, R _G = 50Ω
t _f	Fall Time	—	120	180		Energy losses include "tail" and diode reverse recovery.
E _{on}	Turn-On Switching Loss	—	0.13	—	mJ	See Fig. 9, 10, 11, 18
E _{off}	Turn-Off Switching Loss	—	0.07	—		
E _{ts}	Total Switching Loss	—	0.20	0.3		
t _{d(on)}	Turn-On Delay Time	—	42	—	ns	T _J = 150°C, See Fig. 9, 10, 11, 18
t _r	Rise Time	—	22	—		I _C = 3.9A, V _{CC} = 480V
t _{d(off)}	Turn-Off Delay Time	—	120	—		V _{GE} = 15V, R _G = 50Ω
t _f	Fall Time	—	250	—		Energy losses include "tail" and diode reverse recovery.
C _{ies}	Input Capacitance	—	530	—	pF	V _{GE} = 0V
C _{oes}	Output Capacitance	—	39	—		V _{CC} = 30V See Fig. 7
C _{res}	Reverse Transfer Capacitance	—	7.4	—		f = 1.0MHz
t _{rr}	Diode Reverse Recovery Time	—	37	55	ns	T _J = 25°C See Fig. 14
		—	55	90		T _J = 125°C
I _{rr}	Diode Peak Reverse Recovery Charge	—	3.5	5.0	A	T _J = 25°C See Fig. 15
		—	4.5	8.0		T _J = 125°C
Q _{rr}	Diode Reverse Recovery Charge	—	65	138	nC	T _J = 25°C See Fig. 16
		—	124	360		T _J = 125°C
di _{(rec)M/dt}	Diode Peak Rate of Fall of Recovery During t _b	—	240	—	A/μs	T _J = 25°C See Fig. 17
		—	210	—		T _J = 125°C

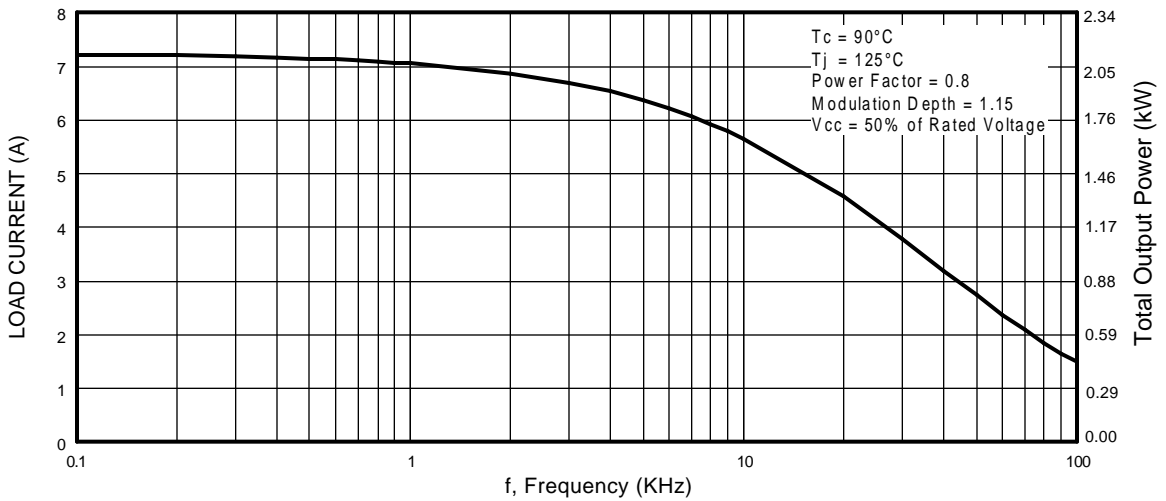

Fig. 1 - Typical Load Current vs. Frequency
(Load Current = I_{RMS} of fundamental)

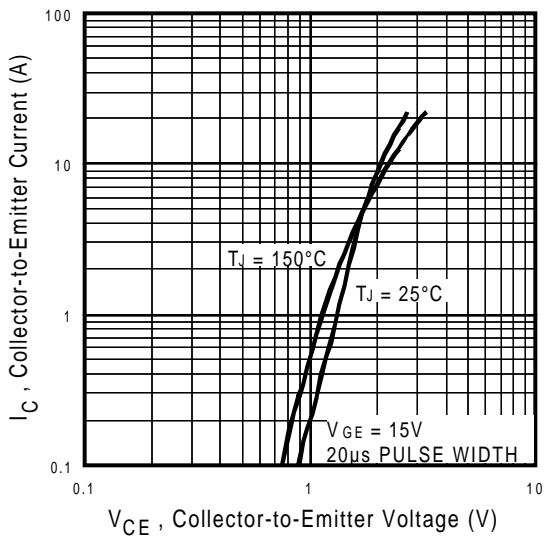

Fig. 2 - Typical Output Characteristics

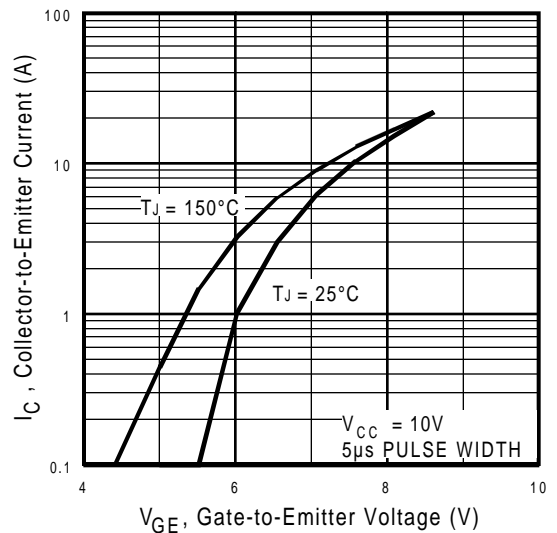

Fig. 3 - Typical Transfer Characteristics

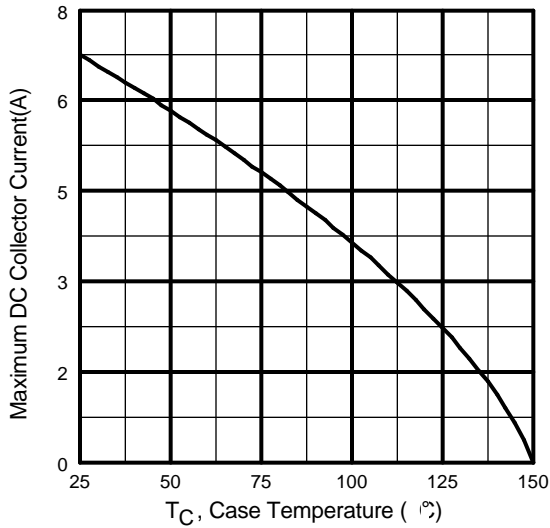

Fig. 4 - Maximum Collector Current vs. Case Temperature

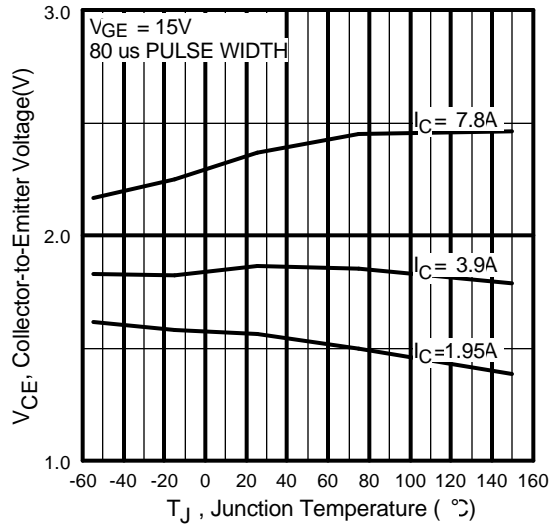

Fig. 5 - Typical Collector-to-Emitter Voltage vs. Junction Temperature

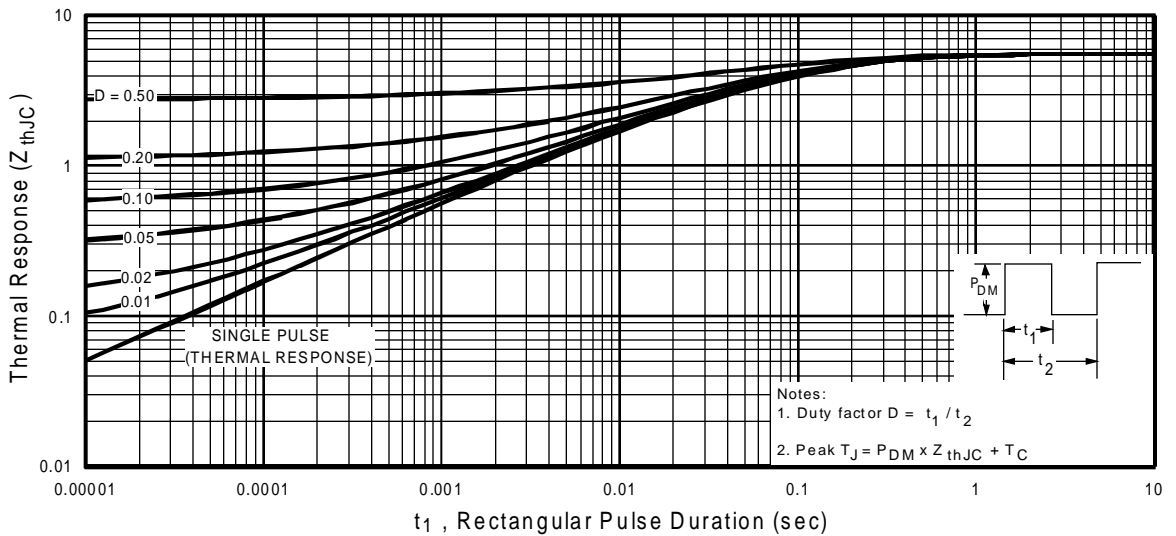

Fig. 6 - Maximum Effective Transient Thermal Impedance, Junction-to-Case

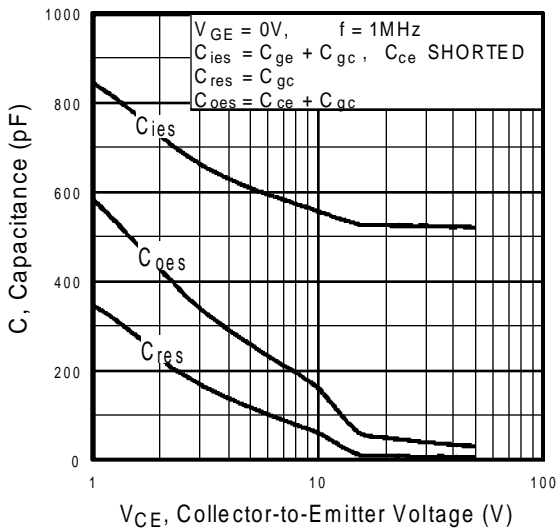

Fig. 7 - Typical Capacitance vs. Collector-to-Emitter Voltage

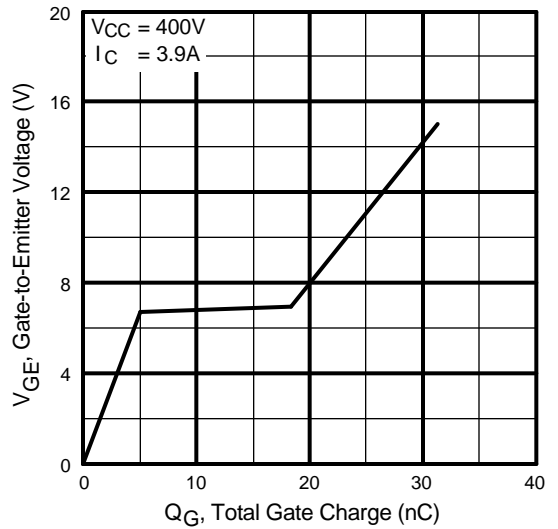

Fig. 8 - Typical Gate Charge vs. Gate-to-Emitter Voltage

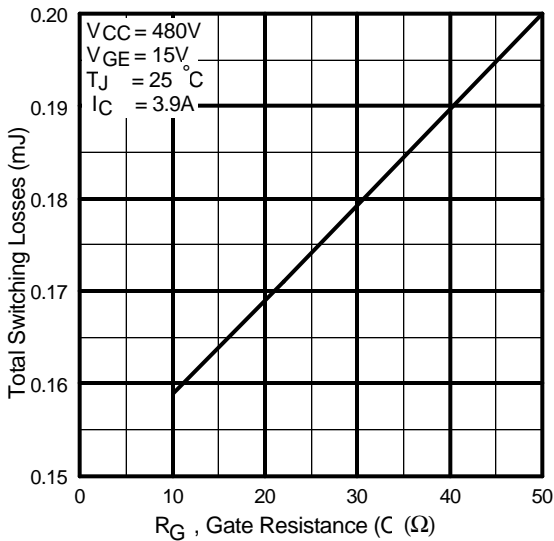

Fig. 9 - Typical Switching Losses vs. Gate Resistance

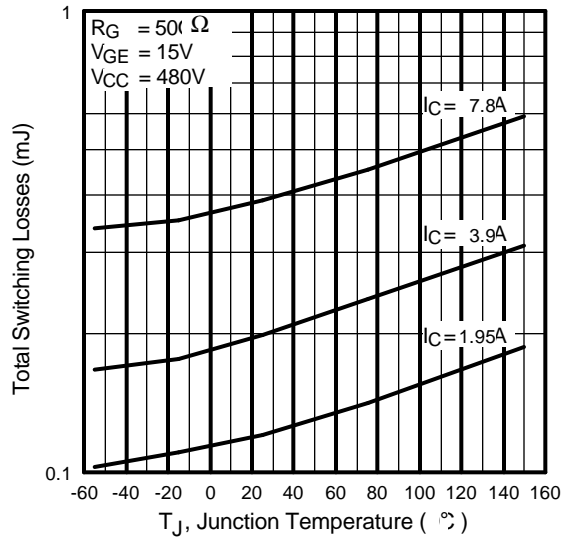

Fig. 10 - Typical Switching Losses vs. Junction Temperature

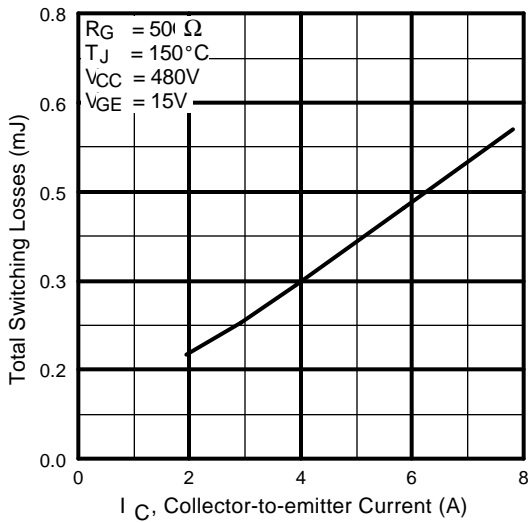

Fig. 11 - Typical Switching Losses vs. Collector-to-Emitter Current

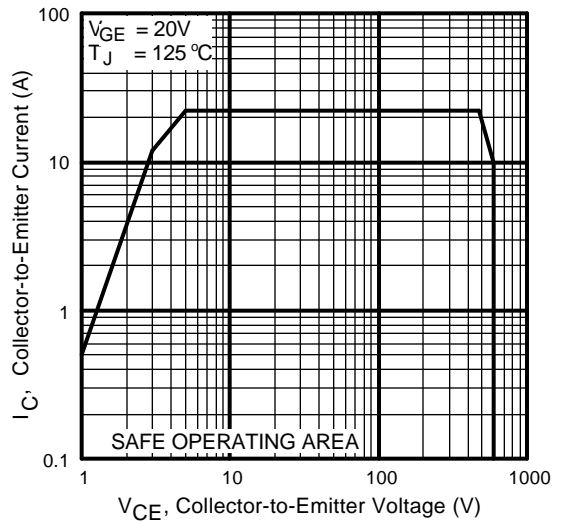

Fig. 12 - Turn-Off SOA

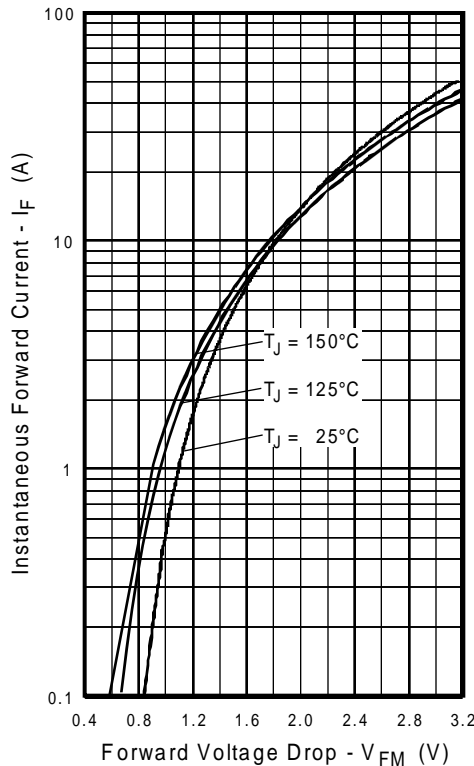

Fig. 13 - Maximum Forward Voltage Drop vs. Instantaneous Forward Current

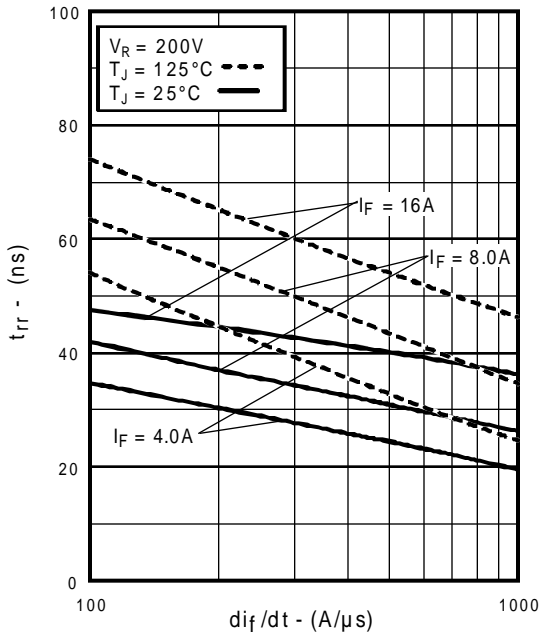

Fig. 14 - Typical Reverse Recovery vs. di/dt

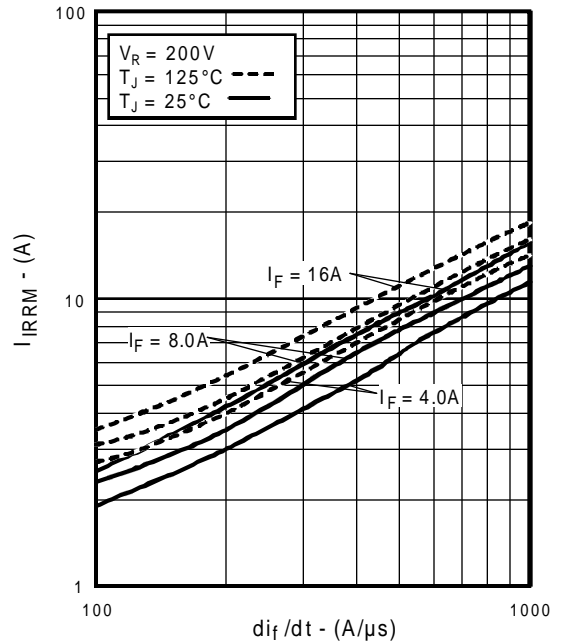

Fig. 15 - Typical Recovery Current vs. di/dt

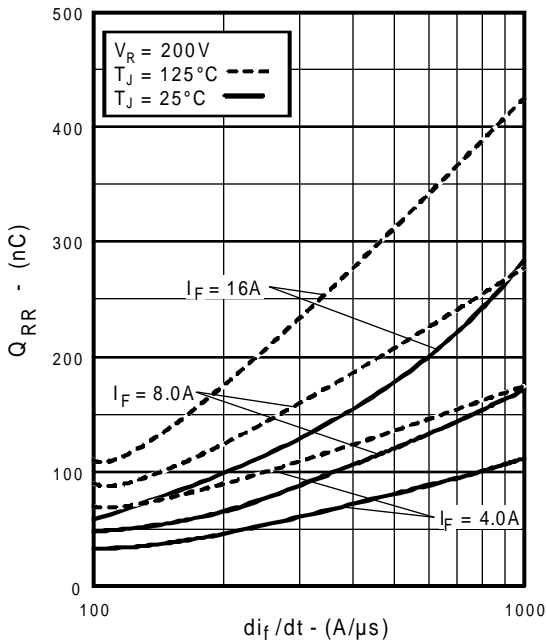

Fig. 16 - Typical Stored Charge vs. di/dt

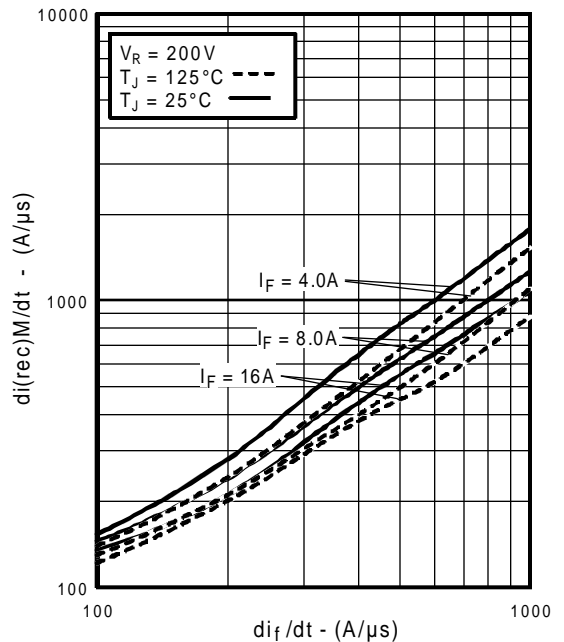

Fig. 17 - Typical $di_{(rec)M}/dt$ vs. di/dt

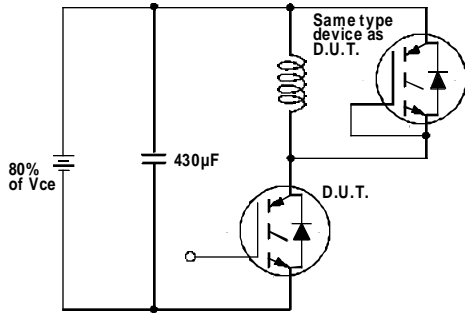

Fig. 18a - Test Circuit for Measurement of I_{LM} , E_{on} , $E_{off}(\text{diode})$, t_{rr} , Q_{rr} , I_{rr} , $t_{d(on)}$, t_r , $t_{d(off)}$, t_f

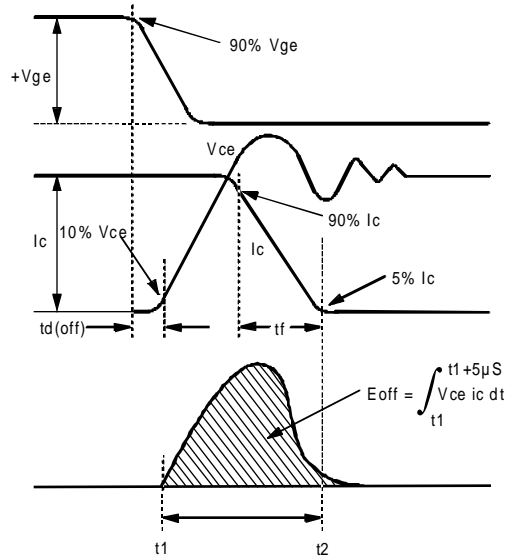

Fig. 18b - Test Waveforms for Circuit of Fig. 18a, Defining E_{off} , $t_{d(off)}$, t_f

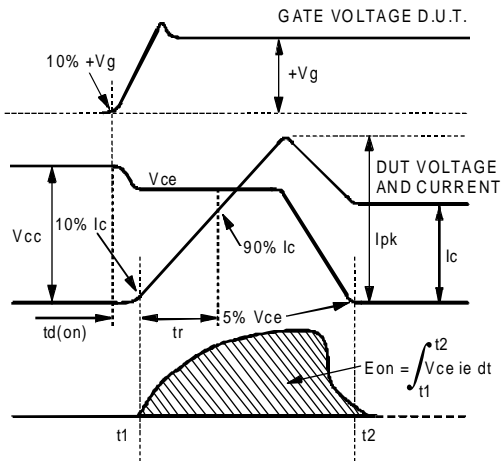

Fig. 18c - Test Waveforms for Circuit of Fig. 18a, Defining E_{on} , $t_{d(on)}$, t_r

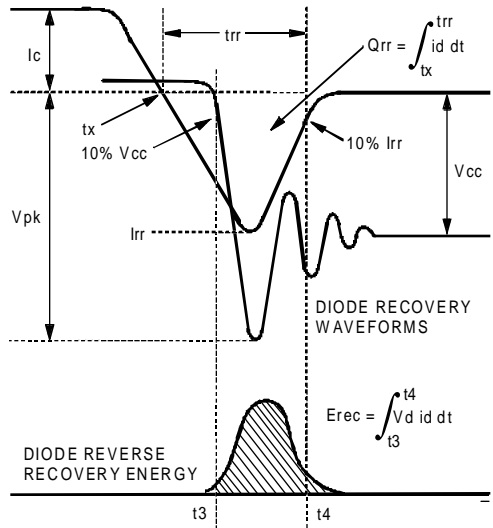

Fig. 18d - Test Waveforms for Circuit of Fig. 18a, Defining E_{rec} , t_{rr} , Q_{rr} , I_{rr}

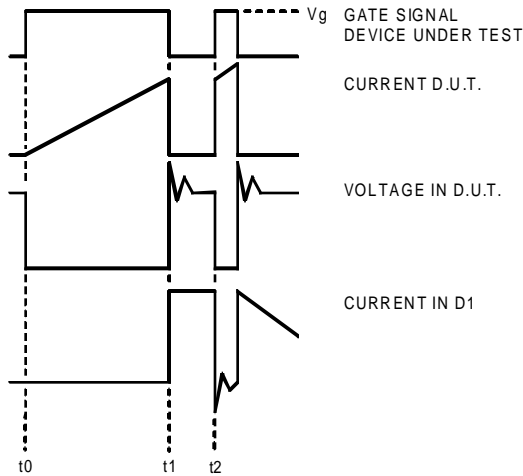

Figure 18e. Macro Waveforms for Figure 18a's Test Circuit

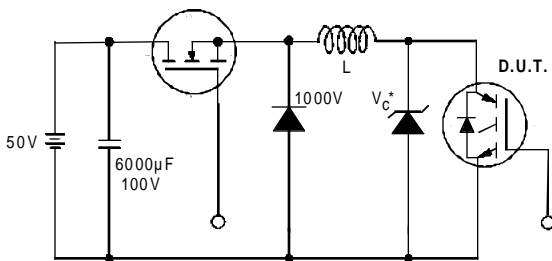

Figure 19. Clamped Inductive Load Test Circuit

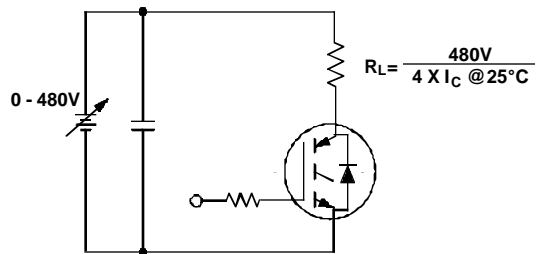

Figure 20. Pulsed Collector Current Test Circuit

Notes:

- ① Repetitive rating: $V_{GE}=20V$; pulse width limited by maximum junction temperature (figure 20)
- ② $V_{CC}=80\%(V_{CES})$, $V_{GE}=20V$, $L=10\mu H$, $R_G = 50\Omega$ (figure 19)
- ③ Pulse width $\leq 80\mu s$; duty factor $\leq 0.1\%$.
- ④ Pulse width $5.0\mu s$, single shot.

Case Outline — IMS-2

