

DMP2-P21111

DMP2

POSITION FINDERS

SICK
Sensor Intelligence.



Ordering information

Type	Part no.
DMP2-P21111	1016237

Other models and accessories → www.sick.com/DMP2



Detailed technical data

Performance

Target	Reflector
Sensing distance	200 mm ... 500 mm (PL22) 500 mm ... 1,200 mm (PL50A) 500 mm ... 2,000 mm (PL80A)
Repeatability	0.15 mm ¹⁾
Response time	3 ms
Switching frequency	250 Hz
Light source	LED, red
Sensing angle	± 10° ²⁾
Operating mode	Choice of continuous or triggered

¹⁾ At 300 mm scanning distance.

²⁾ In all axis perpendicular to the reflector (PL22, PL50A, PL80A)

Interfaces

Switching output	5 x PNP ¹⁾
Blanking input AT	Blanked (triggered): PNP: > 18 V ... > U _v max. Free running: PNP: < 2 V or free running

¹⁾ PNP: Active = V_s - (< 2 V) / Inactive = 0 V;
NPN: Active ≤ 2 V / Inactive = V_s.

Mechanics/electronics

Supply voltage V_s	DC 18 V ... 30 V ¹⁾
Ripple	< 5 V _{pp} ²⁾
Connection type	Male connector, M12, 8-pin
Weight	990 g ³⁾

¹⁾ Limit values, reverse-polarity protected.

²⁾ May not fall short of or exceed V_s tolerances.

³⁾ Incl. cable.

⁴⁾ Without load.

Output current I_A	≤ 100 mA
Current consumption	< 250 mA ⁴⁾

- 1) Limit values, reverse-polarity protected.
- 2) May not fall short of or exceed V_S tolerances.
- 3) Incl. cable.
- 4) Without load.

Ambient data

Enclosure rating	IP 67
Protection class	II ¹⁾
Ambient temperature	Operation: -25 °C ... +55 °C Storage: -25 °C ... +75 °C
Vibration resistance	According to IEC 68

¹⁾ Reference voltage DC 50 V.

Dimensional drawing (Dimensions in mm (inch))

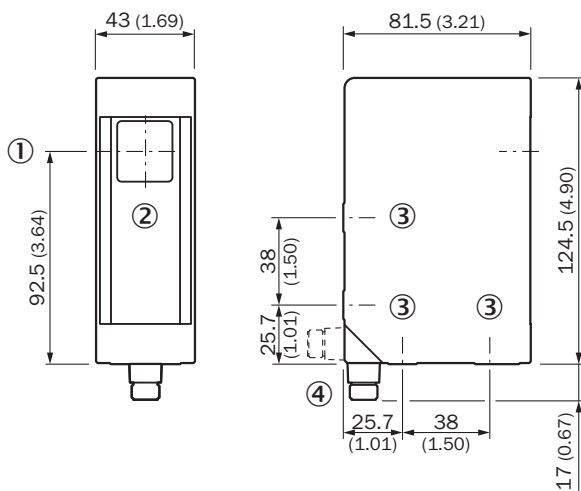

- ① Center of optical axis
- ② Receiver
- ③ Thread borehole M6, 8 mm deep
- ④ Connector M12, 8-pin (rotatable up to 90°)

Connection type

Male connector M12, 8-pin



Connection diagram

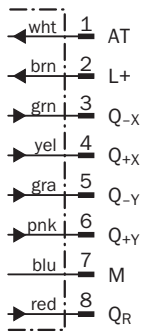

Adjustment possible

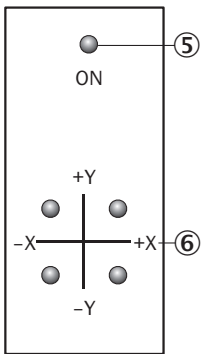

- ⑤ Operating indicator
- ⑥ Adjustment aid

Functional principle

Functional principle: switching status



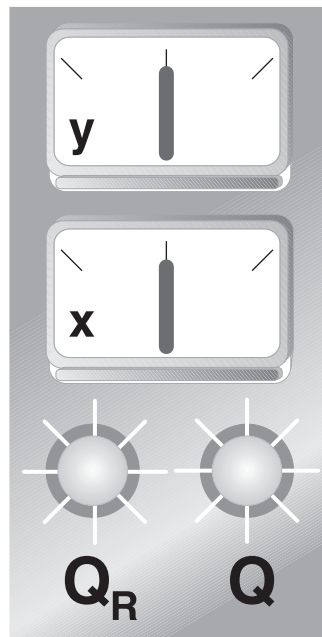
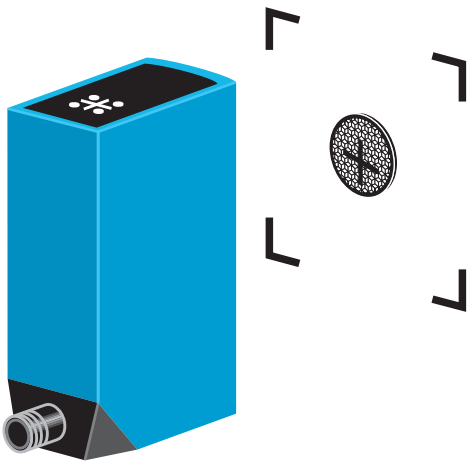
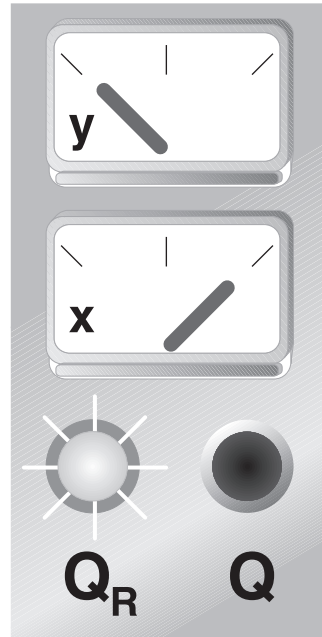
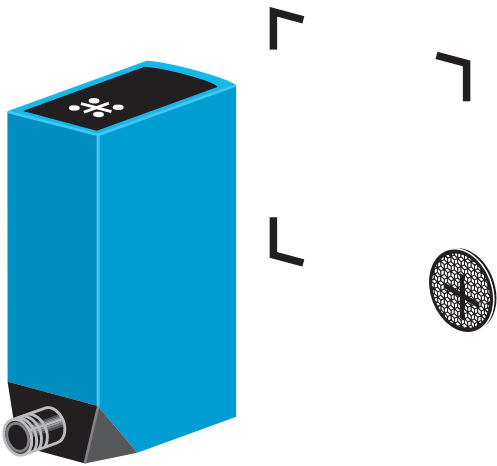

Tolerance	 $Q_{-X} = 1$ $Q_{+X} = 0$ $Q_{-Y} = 0$ $Q_{+Y} = 1$	 $Q_{-X} = 1$ $Q_{+X} = 1$ $Q_{-Y} = 0$ $Q_{+Y} = 1$	 $Q_{-X} = 0$ $Q_{+X} = 1$ $Q_{-Y} = 0$ $Q_{+Y} = 1$
	 $Q_{-X} = 1$ $Q_{+X} = 0$ $Q_{-Y} = 1$ $Q_{+Y} = 1$	 $Q_{-X} = 1$ $Q_{+X} = 1$ $Q_{-Y} = 1$ $Q_{+Y} = 1$	 $Q_{-X} = 0$ $Q_{+X} = 1$ $Q_{-Y} = 1$ $Q_{+Y} = 1$
	 $Q_{-X} = 1$ $Q_{+X} = 0$ $Q_{-Y} = 1$ $Q_{+Y} = 0$	 $Q_{-X} = 1$ $Q_{+X} = 1$ $Q_{-Y} = 1$ $Q_{+Y} = 0$	 $Q_{-X} = 0$ $Q_{+X} = 1$ $Q_{-Y} = 1$ $Q_{+Y} = 0$
	Tolerance		



Recommended accessories

Other models and accessories → www.sick.com/DMP2

	Brief description	Type	Part no.
Terminal and alignment brackets			

	Brief description	Type	Part no.
	Alignment unit for DMP2, incl. mounting material, steel, zinc coated, mounting hardware included	BEF-GH-DMH2	2020796
Plug connectors and cables			
	Head A: female connector, M12, 8-pin, straight Head B: cable Cable: PVC, shielded, 2 m	DOL-1208-G02MA	6020633
	Head A: female connector, M12, 8-pin, straight Head B: cable Cable: PVC, shielded, 5 m	DOL-1208-G05MA	6020993
	Head A: female connector, M12, 8-pin, straight Head B: cable Cable: PVC, shielded, 10 m	DOL-1208-G10MA	6022152
Reflectors			
	Rectangular, screw connection, wrench size 48 mm, PMMA/ABS, Screw-on, 2 hole mounting	PL50A	1000132
	Rectangular, screw connection, 80 mm x 80 mm, PMMA/ABS, Screw-on, 2 hole mounting	PL80A	1003865
	Round, self-adhesive, PMMA/ABS, self-adhesive	PL22-2	1003621

SICK AT A GLANCE

SICK is one of the leading manufacturers of intelligent sensors and sensor solutions for industrial applications. A unique range of products and services creates the perfect basis for controlling processes securely and efficiently, protecting individuals from accidents and preventing damage to the environment.

We have extensive experience in a wide range of industries and understand their processes and requirements. With intelligent sensors, we can deliver exactly what our customers need. In application centers in Europe, Asia and North America, system solutions are tested and optimized in accordance with customer specifications. All this makes us a reliable supplier and development partner.

Comprehensive services complete our offering: SICK LifeTime Services provide support throughout the machine life cycle and ensure safety and productivity.

For us, that is “Sensor Intelligence.”

WORLDWIDE PRESENCE:

Contacts and other locations –www.sick.com