



SANYO Semiconductors

DATA SHEET

An ON Semiconductor Company

2SD1012 — NPN Epitaxial Planar Silicon Transistor

Low-Voltage Large-Current Amplifier Applications

Specifications

Absolute Maximum Ratings at $T_a=25^\circ\text{C}$

| Parameter | Symbol | Conditions | Ratings | Unit |
|------------------------------|-----------|------------|-------------|------------------|
| Collector-to-Base Voltage | V_{CB0} | | 20 | V |
| Collector-to-Emitter Voltage | V_{CE0} | | 15 | V |
| Emitter-to-Base Voltage | V_{EB0} | | 5 | V |
| Collector Current | I_C | | 0.7 | A |
| Collector Current (Pulse) | I_{CP} | | 1.5 | A |
| Collector Dissipation | P_C | | 250 | mW |
| Junction Temperature | T_j | | 125 | $^\circ\text{C}$ |
| Storage Temperature | T_{stg} | | -55 to +125 | $^\circ\text{C}$ |

Package Dimensions

unit : mm (typ)

7524-004

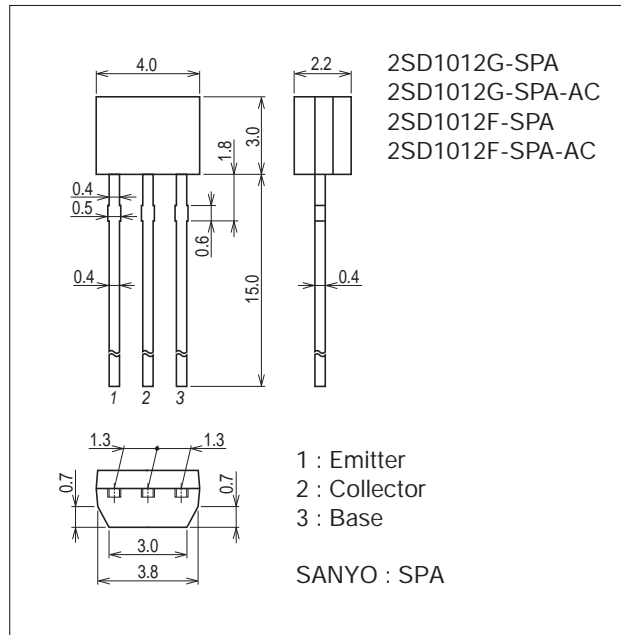

Product & Package Information

- Package : SPA
- JEITA, JEDEC : SC-72
- Minimum Packing Quantity : 2,500 pcs./box, 500pcs./bag

Marking



Electrical Connection

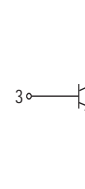

2SD1012

Electrical Characteristics at Ta=25°C

| Parameter | Symbol | Conditions | Ratings | | | Unit |
|---|-----------------------|--|---------|-----|------|------|
| | | | min | typ | max | |
| Collector Cutoff Current | ICBO | V _{CB} =15V, I _E =0A | | | 1.0 | μA |
| Emitter Cutoff Current | IEBO | V _{EB} =4V, I _C =0A | | | 1.0 | μA |
| DC Current Gain | h _{FE1} | V _{CE} =2V, I _C =50mA | 160* | | 960* | |
| | h _{FE2} | V _{CE} =2V, I _C =500mA Pulse | 80 | | | |
| Gain-Bandwidth Product | f _T | V _{CE} =10V, I _C =50mA | | 250 | | MHz |
| Common Base Output Capacitance | Cob | V _{CB} =10V, f=1MHz | | 8 | | pF |
| Collector-to-Emitter Saturation Voltage | V _{CE(sat)1} | I _C =5mA, I _B =0.5mA | | 10 | 25 | mV |
| | V _{CE(sat)2} | I _C =100mA, I _B =10mA | | 30 | 80 | mV |
| Base-to-Emitter Saturation Voltage | V _{BE(sat)} | I _C =100mA, I _B =10mA | | 0.8 | 1.2 | V |
| Collector-to-Base Breakdown Voltage | V(BR)CBO | I _C =10μA, I _E =0A | 20 | | | V |
| Collector-to-Emitter Breakdown Voltage | V(BR)CEO | I _C =1mA, R _{BE} =∞ | 15 | | | V |
| Emitter-to-Base Breakdown Voltage | V(BR)EBO | I _E =10μA, I _C =0A | 5 | | | V |

* : The 2SD1012 is classified by 50mA h_{FE} as follows :

| Rank | F | G | H |
|-----------------|------------|------------|------------|
| h _{FE} | 160 to 320 | 280 to 560 | 480 to 960 |

Ordering Information

| Device | Package | Shipping | memo |
|-----------------|---------|---------------|---------|
| 2SD1012G-SPA | SPA | 500pcs./bag | Pb Free |
| 2SD1012G-SPA-AC | SPA-WA | 2,500pcs./box | |
| 2SD1012F-SPA | SPA | 500pcs./bag | |
| 2SD1012F-SPA-AC | SPA-WA | 2,500pcs./box | |

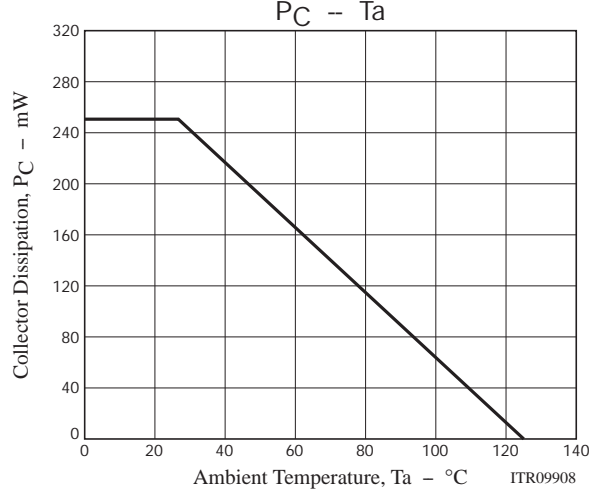
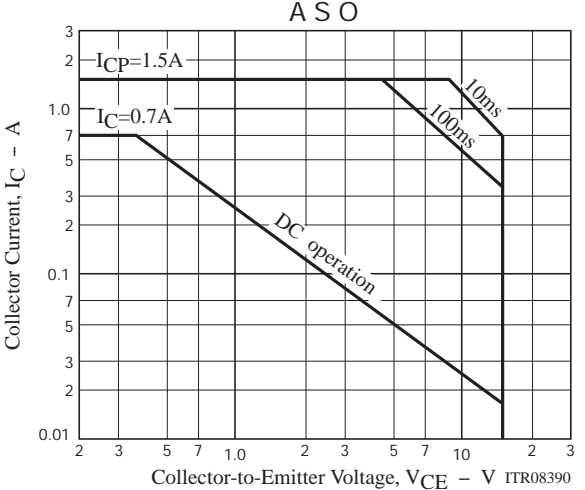
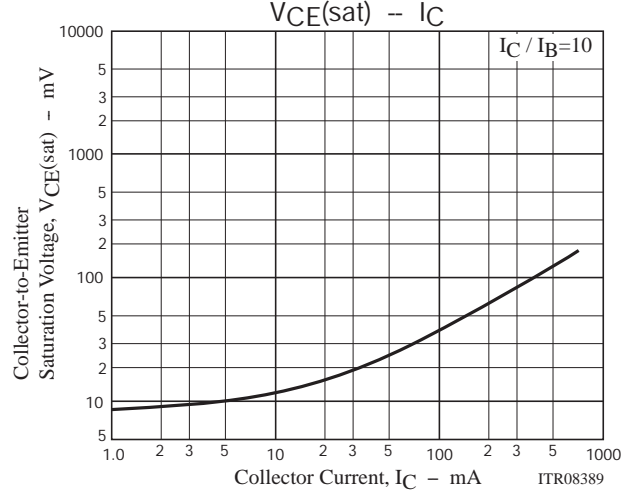
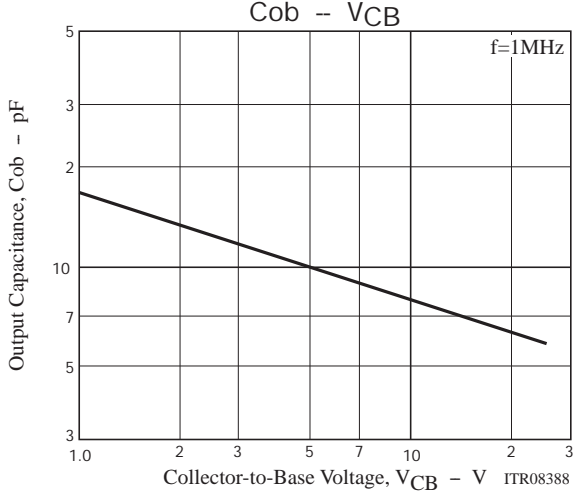
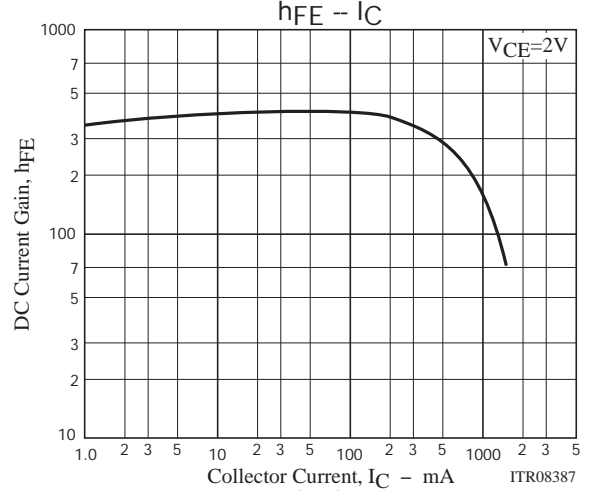
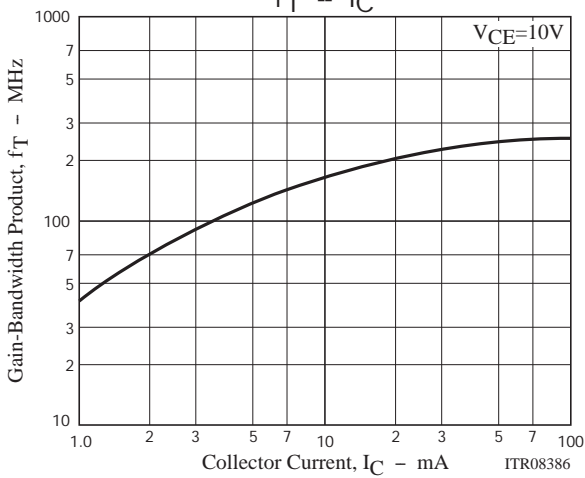
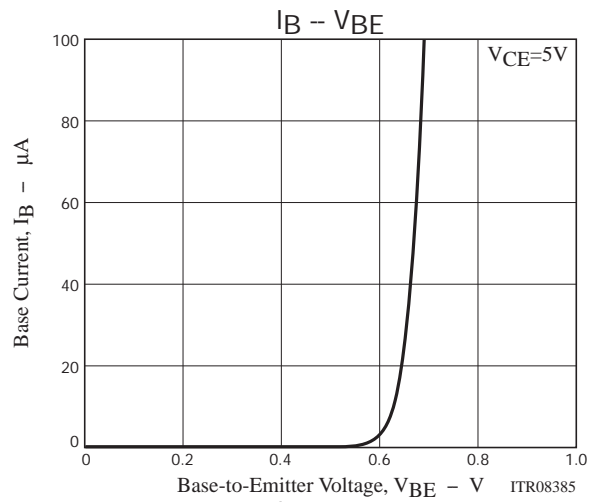
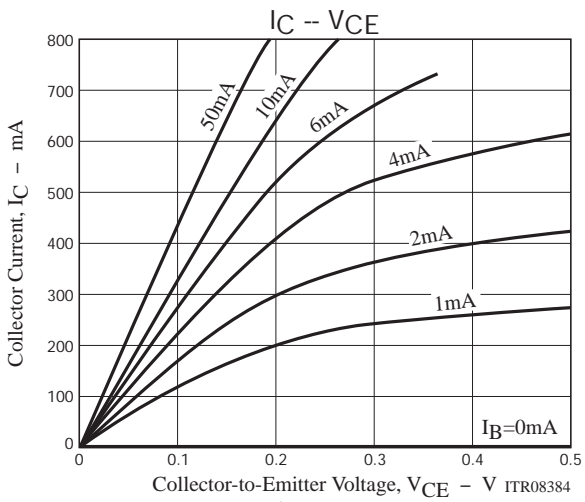

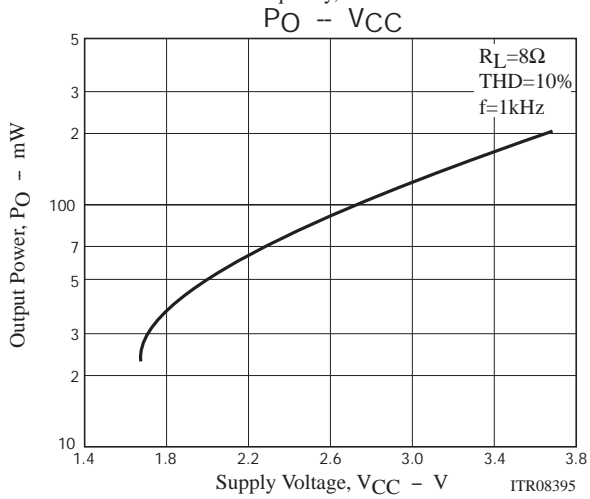
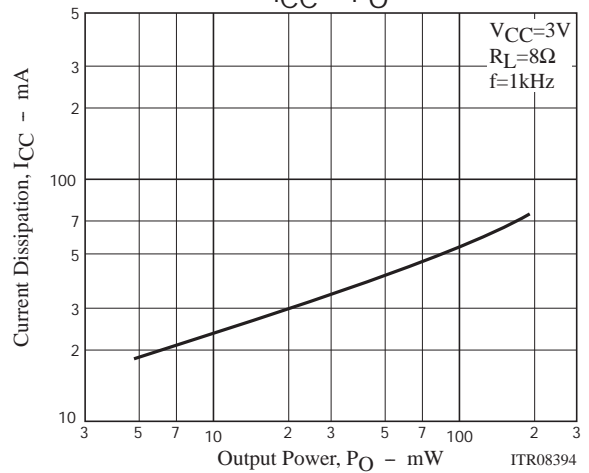
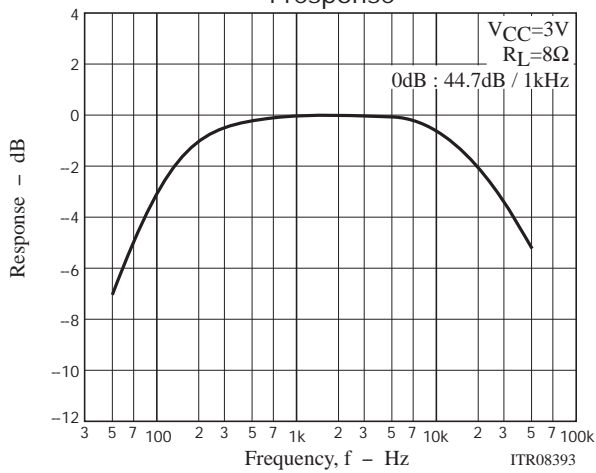
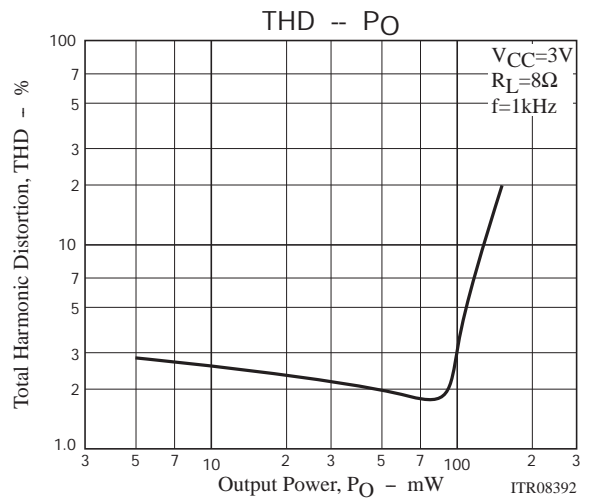
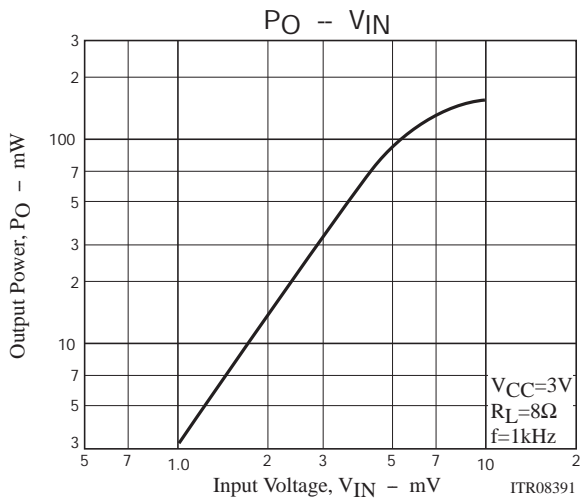

Taping Specification

2SD1012G-SPA-AC, 2SD1012F-SPA-AC

| Storage package Outline name | Package type | Maximum Number of devices contained(pcs.) | | Packing format | |
|------------------------------|--------------|---|------------------|--|---|
| | | Inner box No. | Storage quantity | Outer box (C-6) | Outer box (C-8) |
| SPA | A C | C-2 Inner box Dimensions :mm(external) 330×45×145 | 2,500 | 16 inner boxes contained(40,000pcs.) Outer box Dimensions:mm(external) 585×345×200 | 8 inner boxes contained(20,000pcs.) Outer box Dimensions:mm(external) 345×300×200 |
| | A L | C-2 Inner box Dimensions :mm(external) 330×45×145 | 2,400 | 16 inner boxes contained(38,400pcs.) Outer box Dimensions:mm(external) 585×345×200 | 8 inner boxes contained(19,200pcs.) Outer box Dimensions:mm(internal) 345×300×200 |
| | A P | C-4 Inner box Dimensions :mm(external) 330×45×285 | 5,000 | 8 inner boxes contained(40,000pcs.) Outer box Dimensions:mm(external) 585×345×200 | 4 inner boxes contained(20,000pcs.) Outer box Dimensions:mm(internal) 345×300×200 |
| | A S | C-2 Inner box Dimensions :mm(external) 330×45×145 | 1,200 | 16 inner boxes contained(9,200pcs.) Outer box Dimensions:mm(external) 585×345×200 | 8 inner boxes contained(9,600 pcs.) Outer box Dimensions:mm(internal) 345×300×200 |

1. Packing format

Packing method

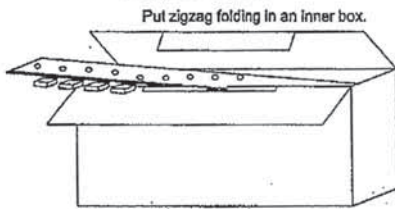

Sample bar code label

(Unit : mm)

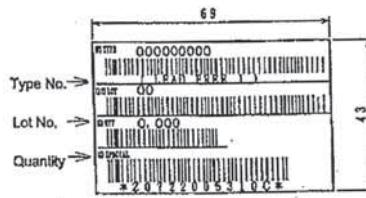

*LEAD FREE 1 :
Lead-free external terminal surface treatment product.

2. Taping specifications

2-1. Carrier tape size (Unit:mm)

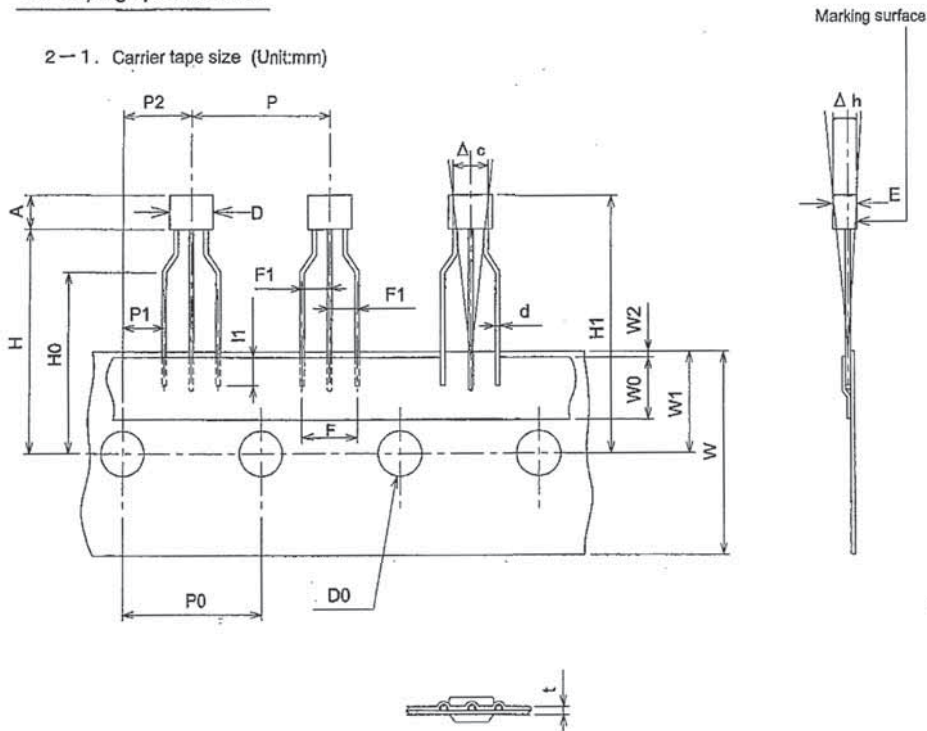

2-2. Taping size standard

Unit:mm

| Item | Symbol | Standard | Tolerance |
|---------------------------------|---------|-------------|---|
| Work piece outside diameter | D | 4.0 | ±0.2 |
| | E | 2.2 | ±0.2 |
| Work piece height | A | 3.0 | ±0.2 |
| Lead wire diameter | d | 0.4 × 0.4 t | ±0.1 |
| Bonded lead wire | l1 | 2.5MIN | |
| Pitch between products | P | 12.7 | ±1.0 |
| Pitch between perforations | P0 | 12.7 | ±0.2 |
| Total pitch for 21 perforations | P0 × 20 | 254.0 | ±1.0 |
| Distance between lead wire | F | 5.0 | +0.8 -0.2 |
| Lead wire pitch distance | F1 | 2.5 | +0.4 -0.1 |
| Product inclination | Δ h | 0 | ±2.0 |
| Displacement of perforations | P1 | 3.85 | ±0.3 |
| | P2 | 6.35 | ±0.3 |
| Displacement of tape | W2 | 0.5MAX | Not to be displaced to the outside of the board |

| Item | Symbol | Standard | Tolerance |
|------------------------------------|--------|----------|---------------|
| Tape width | W | 18.0 | +1.0 -0.5 |
| Adhesive tape | W0 | 6.0 | ±1.0 |
| Displacement of perforations | W1 | 9.0 | +0.75 -0.5 |
| Work piece bottom surface position | H | 19.8 | +1.0 -0.3 |
| Lead wire clinch height | H0 | 16.0 | ±0.5 |
| Work piece upper limit position | H1 | 22.8 | ±1.5 |
| Perforations diameter | D0 | φ 4.0 | ±0.2 |
| Tape thickness (total thickness) | t | 0.6 | ±0.2 |
| Product inclination | Δ c | 0 | ±1.0 |

2-3. Taping structure

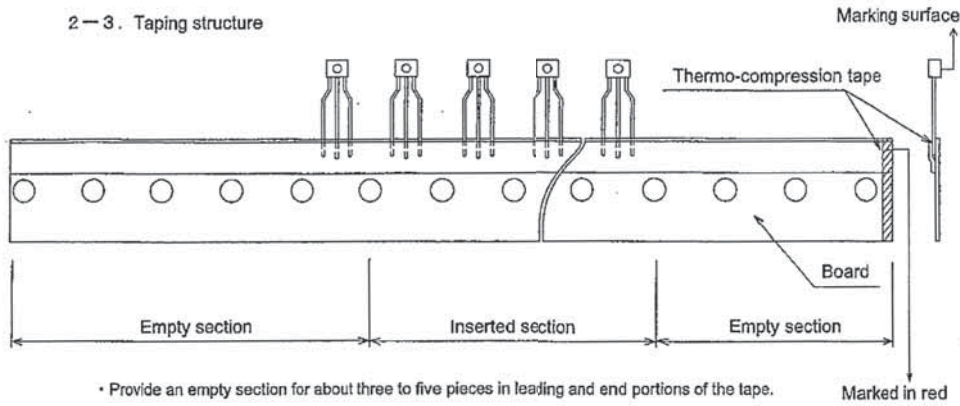

- Provide an empty section for about three to five pieces in leading and end portions of the tape.
- Provide marking in red to the E-side end of the board.

Bag Packing Specification

2SD1012G-SPA, 2SD1012F-SPA

1. Packing Format

| Package Name | Maximum Number of devices contained (pcs) | | | | |
|---|---|------------|------------|-------------|-------------|
| | Bag | Inner BOX | | Outer BOX | |
| SPA | 500 | B-1 | B-1/2 | A-1 | A-2 |
| | | 20,000 | 10,000 | 100,000 | 60,000 |
| Packing format (Dimensions:mm (external)) | | | | | |
| | | Inner BOX | | Outer BOX | |
| | | B-1 | B-1/2 | A-1 | A-2 |
| | | 445×225×55 | 445×225×55 | 470×250×300 | 470×250×190 |

2. Bag dimensions
(unit:mm)

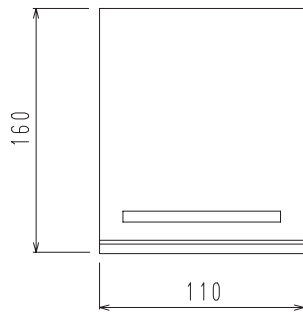

3. Bag label, Inner box label
(unit:mm)

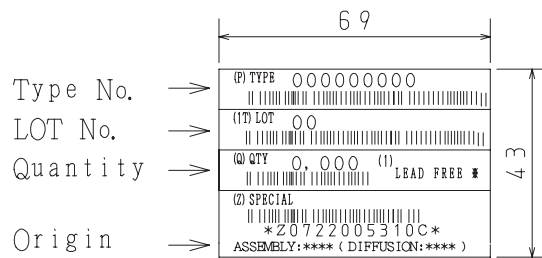

4. Outer box label
(unit:mm)

It is a label at the time of factory shipments. The form of a label may change in physical distribution process.

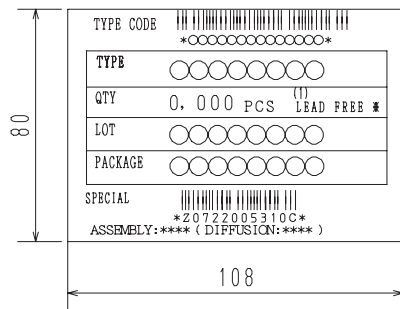

NOTE (1)

The LEAD FREE * description shows that the surface treatment of the terminal is lead free.

| Label | JEITA Phase |
|-------------|----------------|
| LEAD FREE 3 | JEITA Phase 3A |
| LEAD FREE 4 | JEITA Phase 3 |

2SD1012

Outline Drawing

2SD1012G-SPA, 2SD1012F-SPA

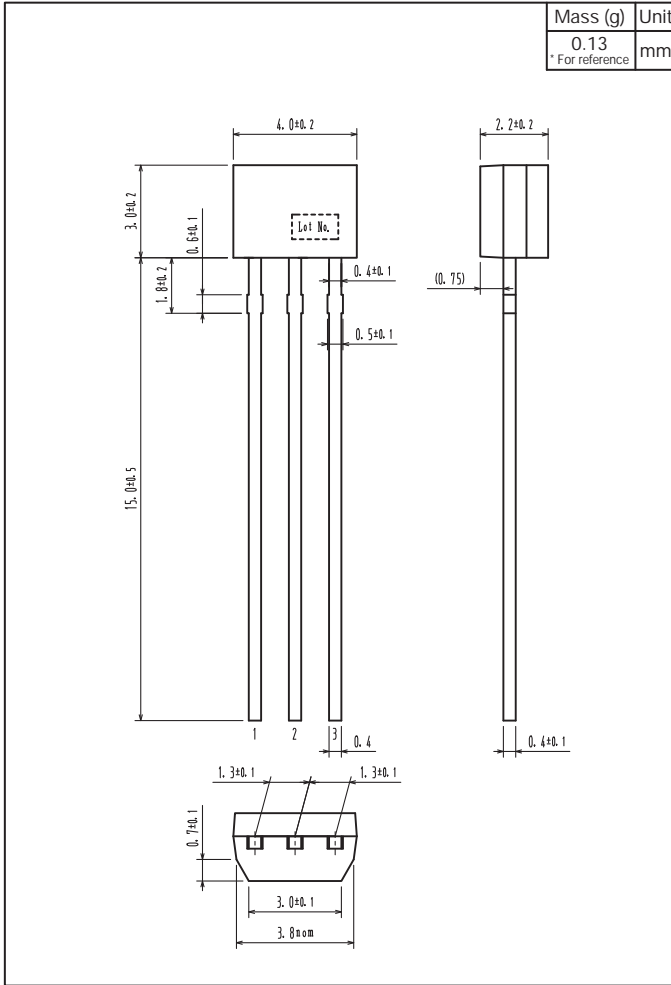

- Any and all SANYO Semiconductor Co.,Ltd. products described or contained herein are, with regard to "standard application", intended for the use as general electronics equipment. The products mentioned herein shall not be intended for use for any "special application" (medical equipment whose purpose is to sustain life, aerospace instrument, nuclear control device, burning appliances, transportation machine, traffic signal system, safety equipment etc.) that shall require extremely high level of reliability and can directly threaten human lives in case of failure or malfunction of the product or may cause harm to human bodies, nor shall they grant any guarantee thereof. If you should intend to use our products for new introduction or other application different from current conditions on the usage of automotive device, communication device, office equipment, industrial equipment etc. , please consult with us about usage condition (temperature, operation time etc.) prior to the intended use. If there is no consultation or inquiry before the intended use, our customer shall be solely responsible for the use.
- Specifications of any and all SANYO Semiconductor Co.,Ltd. products described or contained herein stipulate the performance, characteristics, and functions of the described products in the independent state, and are not guarantees of the performance, characteristics, and functions of the described products as mounted in the customer's products or equipment. To verify symptoms and states that cannot be evaluated in an independent device, the customer should always evaluate and test devices mounted in the customer's products or equipment.
- SANYO Semiconductor Co.,Ltd. assumes no responsibility for equipment failures that result from using products at values that exceed, even momentarily, rated values (such as maximum ratings, operating condition ranges, or other parameters) listed in products specifications of any and all SANYO Semiconductor Co.,Ltd. products described or contained herein.
- Regarding monolithic semiconductors, if you should intend to use this IC continuously under high temperature, high current, high voltage, or drastic temperature change, even if it is used within the range of absolute maximum ratings or operating conditions, there is a possibility of decrease reliability. Please contact us for a confirmation.
- SANYO Semiconductor Co.,Ltd. strives to supply high-quality high-reliability products, however, any and all semiconductor products fail or malfunction with some probability. It is possible that these probabilistic failures or malfunction could give rise to accidents or events that could endanger human lives, trouble that could give rise to smoke or fire, or accidents that could cause damage to other property. When designing equipment, adopt safety measures so that these kinds of accidents or events cannot occur. Such measures include but are not limited to protective circuits and error prevention circuits for safe design, redundant design, and structural design.
- In the event that any or all SANYO Semiconductor Co.,Ltd. products described or contained herein are controlled under any of applicable local export control laws and regulations, such products may require the export license from the authorities concerned in accordance with the above law.
- No part of this publication may be reproduced or transmitted in any form or by any means, electronic or mechanical, including photocopying and recording, or any information storage or retrieval system, or otherwise, without the prior written consent of SANYO Semiconductor Co.,Ltd.
- Any and all information described or contained herein are subject to change without notice due to product/technology improvement, etc. When designing equipment, refer to the "Delivery Specification" for the SANYO Semiconductor Co.,Ltd. product that you intend to use.
- Upon using the technical information or products described herein, neither warranty nor license shall be granted with regard to intellectual property rights or any other rights of SANYO Semiconductor Co.,Ltd. or any third party. SANYO Semiconductor Co.,Ltd. shall not be liable for any claim or suits with regard to a third party's intellectual property rights which has resulted from the use of the technical information and products mentioned above.

This catalog provides information as of October, 2012. Specifications and information herein are subject to change without notice.