

# TC7SPN3125TU, TC7SPN3125WBG

## Low Voltage / Low Power 1-Bit Dual Supply Bus Buffer

The TC7SPN3125 is an advanced high-speed CMOS 1-bit dual supply voltage interface bus buffer fabricated with silicon gate CMOS technology.

It is also designed with over voltage tolerant inputs and outputs up to 3.6 V.

Designed for use as an interface between a 1.2-V, 1.5-V, 1.8-V, or 2.5-V bus and a 1.8-V, 2.5-V or 3.3-V bus in mixed 1.2-V, 1.5-V, 1.8-V or 2.5-V/1.8-V, 2.5-V or 3.3-V supply systems.

The A-input interfaces with the 1.2-V, 1.5-V, 1.8-V or 2.5-V bus, the B-output with the 1.8-V, 2.5-V, 3.3-V bus.

The enable input ( $\overline{OE}$ ) can be used to disable the device so that the signal lines are effectively isolated.

All inputs are equipped with protection circuits against static discharge or transient excess voltage.

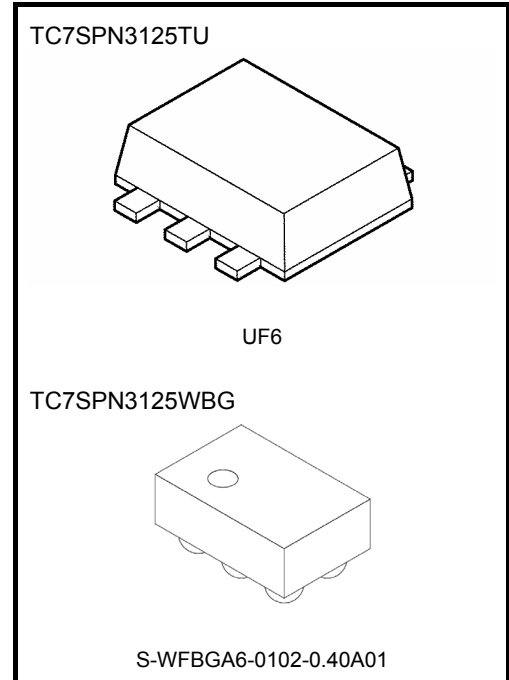

Weight

UF6:	0.007 g (typ.)
S-WFBGA6-0102-0.40A01:	0.001 g (typ.)

### Features (Note)

- Level converter for interfacing 1.2-V to 1.8-V, 1.2-V to 2.5-V, 1.2-V to 3.3-V, 1.5-V to 2.5-V, 1.5-V to 3.3-V, 1.8-V to 2.5-V, 1.8-V to 3.3-V or 2.5-V to 3.3-V system.
- High-speed operation :  $t_{pd} = 13.7$  ns (max) ( $V_{CCA} = 2.5 \pm 0.2$  V,  $V_{CCB} = 3.3 \pm 0.3$  V)  
 $t_{pd} = 14.8$  ns (max) ( $V_{CCA} = 1.8 \pm 0.15$  V,  $V_{CCB} = 3.3 \pm 0.3$  V)  
 $t_{pd} = 16.0$  ns (max) ( $V_{CCA} = 1.5 \pm 0.1$  V,  $V_{CCB} = 3.3 \pm 0.3$  V)  
 $t_{pd} = 29$  ns (max) ( $V_{CCA} = 1.2 \pm 0.1$  V,  $V_{CCB} = 3.3 \pm 0.3$  V)  
 $t_{pd} = 18.5$  ns (max) ( $V_{CCA} = 1.8 \pm 0.15$  V,  $V_{CCB} = 2.5 \pm 0.2$  V)  
 $t_{pd} = 19.7$  ns (max) ( $V_{CCA} = 1.5 \pm 0.1$  V,  $V_{CCB} = 2.5 \pm 0.2$  V)  
 $t_{pd} = 33$  ns (max) ( $V_{CCA} = 1.2 \pm 0.1$  V,  $V_{CCB} = 2.5 \pm 0.2$  V)  
 $t_{pd} = 43$  ns (max) ( $V_{CCA} = 1.2 \pm 0.1$  V,  $V_{CCB} = 1.8 \pm 0.15$  V)
- Output current :  $I_{OHB} / I_{OLB} = \pm 3$  mA (min) ( $V_{CCB} = 3.0$  V)  
 $I_{OHB} / I_{OLB} = \pm 2$  mA (min) ( $V_{CCB} = 2.3$  V)  
 $I_{OHB} / I_{OLB} = \pm 0.5$  mA (min) ( $V_{CCB} = 1.65$  V)
- Latch-up performance: -300 mA
- ESD performance: Machine model  $\geq \pm 200$  V  
Human body model  $\geq \pm 2000$  V
- Ultra-small package: UF6, WCSP6
- Low current consumption: Using the new circuit significantly reduces current consumption when  $\overline{OE} = "H"$ .  
Suitable for battery-driven applications such as PDAs and cellular phones.
- Floating A-bus is permitted. (when  $\overline{OE} = "H"$ )
- 3.6-V tolerant function and power-down protection provided on all inputs and outputs.

Note: Do not apply a signal to any bus pins when it is in the output mode. Damage may result.

Start of commercial production  
2005-07

## Pin Assignment (top view)

TC7SPN3125TU

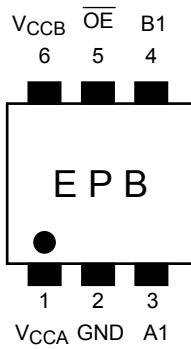

TC7SPN3125WBG

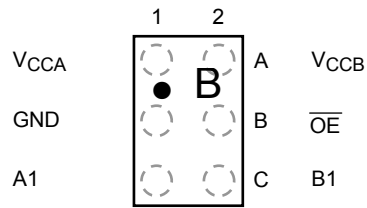

## Truth Table

Inputs		Output
$\overline{OE}$	A1	B1
L	L	L
L	H	H
H	X	Z

X: Don't care

Z: High impedance

## Block Diagram

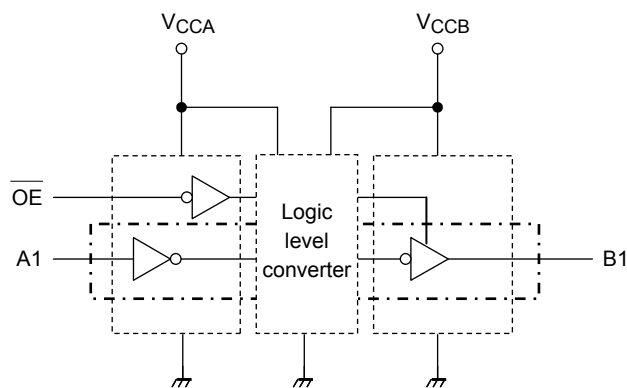

## Absolute Maximum Ratings (Note 1)

Characteristics	Symbol	Rating	Unit
Power supply voltage (Note 2)	V <sub>CCA</sub>	-0.5 to 4.6	V
	V <sub>CCB</sub>	-0.5 to 4.6	
DC input voltage (A1, $\overline{OE}$ )	V <sub>IN</sub>	-0.5 to 4.6	V
DC output voltage (B1)	V <sub>OUTB</sub>	-0.5 to 4.6 (Note 3)	V
		-0.5 to V <sub>CCB</sub> + 0.5 (Note 4)	
Input diode current	I <sub>IK</sub>	-25	mA
Output diode current	I <sub>OK</sub>	±50 (Note 5)	mA
DC output current	I <sub>OUTB</sub>	±6	mA
DC V <sub>CC</sub> /ground current per supply pin	I <sub>CCA</sub>	±25	mA
	I <sub>CCB</sub>	±50	
Power dissipation	P <sub>D</sub>	200 (UF6) / 100 (WCSP6)	mW
Storage temperature	T <sub>stg</sub>	-65 to 150	°C

Note 1: Exceeding any of the absolute maximum ratings, even briefly, lead to deterioration in IC performance or even destruction.

Using continuously under heavy loads (e.g. the application of high temperature/current/voltage and the significant change in temperature, etc.) may cause this product to decrease in the reliability significantly even if the operating conditions (i.e. operating temperature/current/voltage, etc.) are within the absolute maximum ratings and the operating ranges.

Please design the appropriate reliability upon reviewing the Toshiba Semiconductor Reliability Handbook ("Handling Precautions"/"Derating Concept and Methods") and individual reliability data (i.e. reliability test report and estimated failure rate, etc).

Note 2: Don't supply a voltage to V<sub>CCB</sub> pin when V<sub>CCA</sub> is in the OFF state.

Note 3: Output in OFF state

Note 4: High or Low state. I<sub>OUT</sub> absolute maximum rating must be observed.

Note 5: V<sub>OUT</sub> < GND, V<sub>OUT</sub> > V<sub>CC</sub>

## Operating Ranges (Note 1)

Characteristics	Symbol	Rating	Unit
Power supply voltage	V <sub>CCA</sub>	1.1 to 2.7	V
	V <sub>CCB</sub>	1.65 to 3.6	
Input voltage (A1, $\overline{OE}$ )	V <sub>IN</sub>	0 to 3.6	V
Output voltage (B1)	V <sub>OUTB</sub>	0 to 3.6 (Note 2)	V
		0 to V <sub>CCB</sub> (Note 3)	
Output current (B1)	I <sub>OUTB</sub>	±3 (Note 4)	mA
		±2 (Note 5)	
		±0.5 (Note 6)	
Operating temperature	T <sub>opr</sub>	-40 to 85	°C
Input rise and fall time	dt/dv	0 to 10 (Note 7)	ns/V

Note 1: The operating ranges must be maintained to ensure the normal operation of the device. Unused inputs must be tied to either V<sub>CC</sub> or GND.

Note 2: Output in OFF state

Note 3: High or low state

Note 4: V<sub>CCB</sub> = 3.0 to 3.6 V

Note 5: V<sub>CCB</sub> = 2.3 to 2.7 V

Note 6: V<sub>CCB</sub> = 1.65 to 1.95 V

Note 7: V<sub>IN</sub> = 0.8 to 2.0 V, V<sub>CCA</sub> = 2.5 V, V<sub>CCB</sub> = 3.0 V

## Electrical Characteristics

### DC Characteristics (1.1 V ≤ V<sub>CCA</sub> ≤ 2.7 V, 1.65 V ≤ V<sub>CCB</sub> ≤ 3.6 V)

Characteristics	Symbol	Test Condition	V <sub>CCA</sub> (V)	V <sub>CCB</sub> (V)	Ta = -40 to 85°C		Unit	
					Min	Max		
H-level input voltage	V <sub>IHA</sub>	$\overline{OE}$ , A1	1.1 ≤ V <sub>CCA</sub> < 1.4	1.65 to 3.6	0.65× V <sub>CCA</sub>	—	V	
			1.4 ≤ V <sub>CCA</sub> < 1.65	1.65 to 3.6	0.65× V <sub>CCA</sub>	—		
			1.65 ≤ V <sub>CCA</sub> < 2.3	2.3 to 3.6	0.65× V <sub>CCA</sub>	—		
			2.3 ≤ V <sub>CCA</sub> < 2.7	2.7 to 3.6	1.6	—		
L-level input voltage	V <sub>ILA</sub>	$\overline{OE}$ , A1	1.1 ≤ V <sub>CCA</sub> < 1.4	1.65 to 3.6	—	0.30× V <sub>CCA</sub>	V	
			1.4 ≤ V <sub>CCA</sub> < 1.65	1.65 to 3.6	—	0.30× V <sub>CCA</sub>		
			1.65 ≤ V <sub>CCA</sub> < 2.3	2.3 to 3.6	—	0.35× V <sub>CCA</sub>		
			2.3 ≤ V <sub>CCA</sub> < 2.7	2.7 to 3.6	—	0.7		
H-level output voltage	V <sub>OHB</sub>	A1 = V <sub>IH</sub>	I <sub>OHB</sub> = -100 μA	1.1 to 2.7	1.65 to 3.6	V <sub>CCB</sub> - 0.2	V	
			I <sub>OHB</sub> = -0.5 mA	1.1 to 1.65	1.65	1.25		—
			I <sub>OHB</sub> = -2 mA	1.1 to 2.3	2.3	1.7		—
			I <sub>OHB</sub> = -3 mA	1.1 to 2.7	3.0	2.2		—
L-level output voltage	V <sub>OLB</sub>	A1 = V <sub>IL</sub>	I <sub>OLB</sub> = 100 μA	1.1 to 2.7	1.65 to 3.6	—	V	
			I <sub>OLB</sub> = 0.5 mA	1.1 to 1.65	1.65	—		0.3
			I <sub>OLB</sub> = 2 mA	1.1 to 2.3	2.3	—		0.6
			I <sub>OLB</sub> = 3 mA	1.1 to 2.7	3.0	—		0.55
3-state output OFF state current	I <sub>OZB</sub>	A1 = V <sub>IHA</sub> or V <sub>ILA</sub> B1 = 0 to 3.6 V	1.1 to 2.7	1.65 to 3.6	—	±2.0	μA	
Input leakage current	I <sub>IN</sub>	V <sub>IN</sub> = 0 to 3.6 V	1.1 to 2.7	1.65 to 3.6	—	±1.0	μA	
Power-off leakage current	I <sub>OFF1</sub>	V <sub>IN</sub> , B1 = 0 to 3.6 V	0	0	—	2.0	μA	
	I <sub>OFF2</sub>	$\overline{OE}$ = V <sub>CCA</sub>	1.1 to 2.7	0	—	2.0		
	I <sub>OFF3</sub>	A1, B1 = 0 to 3.6 V	1.1 to 2.7	Open	—	2.0		
Quiescent supply current	I <sub>CCA</sub>	V <sub>IN</sub> = V <sub>CCA</sub> or GND	1.1 to 2.7	1.65 to 3.6	—	2.0	μA	
	I <sub>CCB</sub>	V <sub>IN</sub> = V <sub>CCA</sub> or GND	1.1 to 2.7	1.65 to 3.6	—	2.0		
	I <sub>CCA</sub>	V <sub>CCA</sub> < V <sub>IN</sub> ≤ 3.6 V	1.1 to 2.7	1.65 to 3.6	—	±2.0		
	I <sub>CCB</sub>	V <sub>IN</sub> = V <sub>CCA</sub> V <sub>CCB</sub> ≤ B1 ≤ 3.6 V	1.1 to 2.7	1.65 to 3.6	—	±2.0		

## AC Characteristics (Ta = -40 to 85°C, Input: tr = tf = 2.0 ns)

**VCCA = 2.5 ± 0.2 V, VCCB = 3.3 ± 0.3 V**

Characteristics	Symbol	Test Condition	Min	Max	Unit
Propagation delay time (A1 → B1)	t <sub>pLH</sub>	Figure 1, Figure 2	1.0	13.7	ns
	t <sub>pHL</sub>				
3-state output enable time ( $\overline{\text{OE}}$ → B1)	t <sub>pZL</sub>	Figure 1, Figure 3	1.0	16.6	
	t <sub>pZH</sub>				
3-state output disable time ( $\overline{\text{OE}}$ → B1)	t <sub>pLZ</sub>	Figure 1, Figure 3	1.0	7.2	
	t <sub>pHZ</sub>				

**VCCA = 1.8 ± 0.15 V, VCCB = 3.3 ± 0.3 V**

Characteristics	Symbol	Test Condition	Min	Max	Unit
Propagation delay time (A1 → B1)	t <sub>pLH</sub>	Figure 1, Figure 2	1.0	14.8	ns
	t <sub>pHL</sub>				
3-state output enable time ( $\overline{\text{OE}}$ → B1)	t <sub>pZL</sub>	Figure 1, Figure 3	1.0	18.9	
	t <sub>pZH</sub>				
3-state output disable time ( $\overline{\text{OE}}$ → B1)	t <sub>pLZ</sub>	Figure 1, Figure 3	1.0	8.7	
	t <sub>pHZ</sub>				

**VCCA = 1.5 ± 0.1 V, VCCB = 3.3 ± 0.3 V**

Characteristics	Symbol	Test Condition	Min	Max	Unit
Propagation delay time (A1 → B1)	t <sub>pLH</sub>	Figure 1, Figure 2	1.0	16.0	ns
	t <sub>pHL</sub>				
3-state output enable time ( $\overline{\text{OE}}$ → B1)	t <sub>pZL</sub>	Figure 1, Figure 3	1.0	22.8	
	t <sub>pZH</sub>				
3-state output disable time ( $\overline{\text{OE}}$ → B1)	t <sub>pLZ</sub>	Figure 1, Figure 3	1.0	10.2	
	t <sub>pHZ</sub>				

**VCCA = 1.2 ± 0.1 V, VCCB = 3.3 ± 0.3 V**

Characteristics	Symbol	Test Condition	Min	Max	Unit
Propagation delay time (A1 → B1)	t <sub>pLH</sub>	Figure 1, Figure 2	1.0	29	ns
	t <sub>pHL</sub>				
3-state output enable time ( $\overline{\text{OE}}$ → B1)	t <sub>pZL</sub>	Figure 1, Figure 3	1.0	63	
	t <sub>pZH</sub>				
3-state output disable time ( $\overline{\text{OE}}$ → B1)	t <sub>pLZ</sub>	Figure 1, Figure 3	1.0	23	
	t <sub>pHZ</sub>				

**$V_{CCA} = 1.8 \pm 0.15 \text{ V}$ ,  $V_{CCB} = 2.5 \pm 0.2 \text{ V}$**

Characteristics	Symbol	Test Condition	Min	Max	Unit
Propagation delay time (A1 → B1)	$t_{pLH}$ $t_{pHL}$	Figure 1, Figure 2	1.0	18.5	ns
3-state output enable time ( $\overline{OE}$ → B1)	$t_{pZL}$ $t_{pZH}$	Figure 1, Figure 3	1.0	23.6	
3-state output disable time ( $\overline{OE}$ → B1)	$t_{pLZ}$ $t_{pHZ}$	Figure 1, Figure 3	1.0	6.9	

**$V_{CCA} = 1.5 \pm 0.1 \text{ V}$ ,  $V_{CCB} = 2.5 \pm 0.2 \text{ V}$**

Characteristics	Symbol	Test Condition	Min	Max	Unit
Propagation delay time (A1 → B1)	$t_{pLH}$ $t_{pHL}$	Figure 1, Figure 2	1.0	19.7	ns
3-state output enable time ( $\overline{OE}$ → B1)	$t_{pZL}$ $t_{pZH}$	Figure 1, Figure 3	1.0	26.6	
3-state output disable time ( $\overline{OE}$ → B1)	$t_{pLZ}$ $t_{pHZ}$	Figure 1, Figure 3	1.0	8.3	

**$V_{CCA} = 1.2 \pm 0.1 \text{ V}$ ,  $V_{CCB} = 2.5 \pm 0.2 \text{ V}$**

Characteristics	Symbol	Test Condition	Min	Max	Unit
Propagation delay time (A1 → B1)	$t_{pLH}$ $t_{pHL}$	Figure 1, Figure 2	1.0	33	ns
3-state output enable time ( $\overline{OE}$ → B1)	$t_{pZL}$ $t_{pZH}$	Figure 1, Figure 3	1.0	66	
3-state output disable time ( $\overline{OE}$ → B1)	$t_{pLZ}$ $t_{pHZ}$	Figure 1, Figure 3	1.0	20	

**$V_{CCA} = 1.2 \pm 0.1 \text{ V}$ ,  $V_{CCB} = 1.8 \pm 0.15 \text{ V}$**

Characteristics	Symbol	Test Condition	Min	Max	Unit
Propagation delay time (A1 → B1)	$t_{pLH}$ $t_{pHL}$	Figure 1, Figure 2	1.0	43	ns
3-state output enable time ( $\overline{OE}$ → B1)	$t_{pZL}$ $t_{pZH}$	Figure 1, Figure 3	1.0	78	
3-state output disable time ( $\overline{OE}$ → B1)	$t_{pLZ}$ $t_{pHZ}$	Figure 1, Figure 3	1.0	20	

**Capacitive Characteristics (Ta=25°C)**

Characteristics	Symbol	Test Condition	V <sub>CCB</sub> (V)		Typ.	Unit
			V <sub>CCA</sub> (V)	V <sub>CCB</sub> (V)		
Input capacitance	C <sub>IN</sub>	$\overline{OE}$ , A1	2.5	3.3	7	pF
Output capacitance	C <sub>OUT</sub>	B1	2.5	3.3	8	pF
Power dissipation capacitance (Note)	C <sub>PD</sub> A	$\overline{OE}$ = "L"	2.5	3.3	3	pF
		$\overline{OE}$ = "H"	2.5	3.3	0	
	C <sub>PD</sub> B	$\overline{OE}$ = "L"	2.5	3.3	13	
		$\overline{OE}$ = "H"	2.5	3.3	0	

Note: C<sub>PD</sub> is defined as the value of the internal equivalent capacitance which is calculated from the operating current consumption without load.

Average operating current can be obtained by the equation:

$$I_{CC (opr)} = C_{PD} \cdot V_{CC} \cdot f_{IN} + I_{CC} / 2 \text{ (per pin)}$$

**AC Test Circuit**

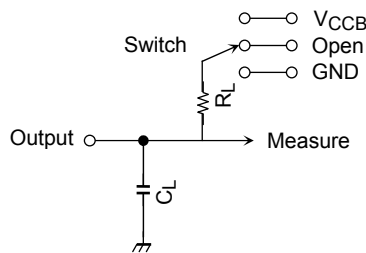

Parameter	Switch
t <sub>pLH</sub> , t <sub>pHL</sub>	Open
t <sub>pLZ</sub> , t <sub>pZL</sub>	V <sub>CCB</sub>
t <sub>pHZ</sub> , t <sub>pZH</sub>	GND

Symbol	V <sub>CCB</sub>	
	3.3 ± 0.3 V 2.5 ± 0.2 V	1.8 ± 0.15 V
R <sub>L</sub>	1 kΩ	1 kΩ
C <sub>L</sub>	30 pF	30 pF

**Figure 1**

**AC Waveform**

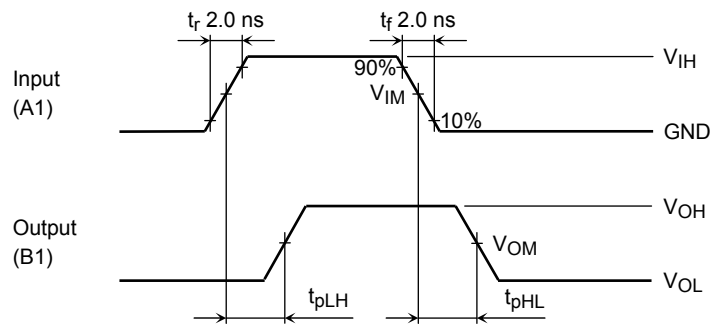

**Figure 2**  $t_{pLH}$ ,  $t_{pHL}$

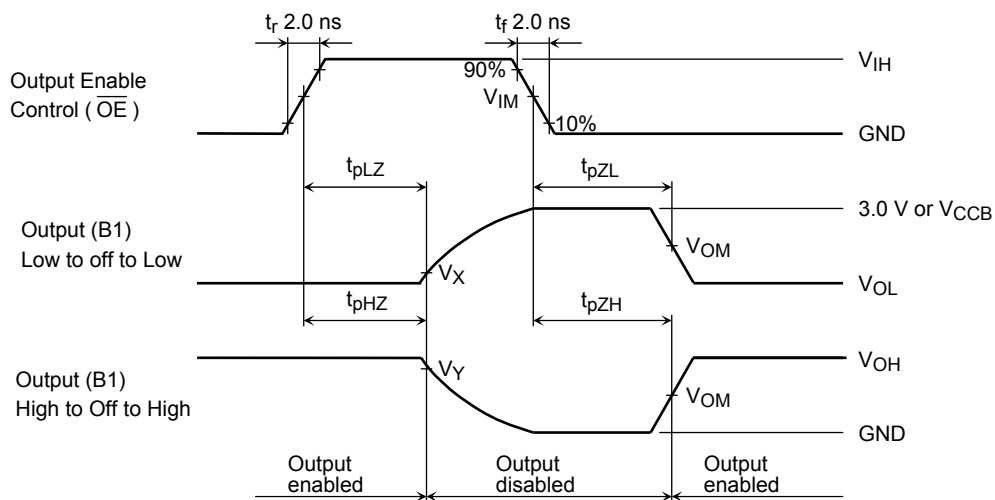

**Figure 3**  $t_{pLZ}$ ,  $t_{pHZ}$ ,  $t_{pZL}$ ,  $t_{pZH}$

	Symbol	$V_{CCA}, V_{CCB}$		
		$3.3 \pm 0.3 \text{ V}$	$2.5 \pm 0.2 \text{ V}$ $1.8 \pm 0.15 \text{ V}$	$1.5 \pm 0.1 \text{ V}$ $1.2 \pm 0.1 \text{ V}$
Input	$V_{IH}$	-	$V_{CCA}$	$V_{CCA}$
	$V_{IM}$	-	$V_{CCA} / 2$	$V_{CCA} / 2$
Output	$V_{OM}$	$V_{OH} / 2$	$V_{OH} / 2$	-
	$V_X$	$V_{OL} + 0.3 \text{ V}$	$V_{OH} + 0.15 \text{ V}$	-
	$V_Y$	$V_{OH} - 0.3 \text{ V}$	$V_{OH} - 0.15 \text{ V}$	-



**Package Dimensions**

UF6

Unit: mm

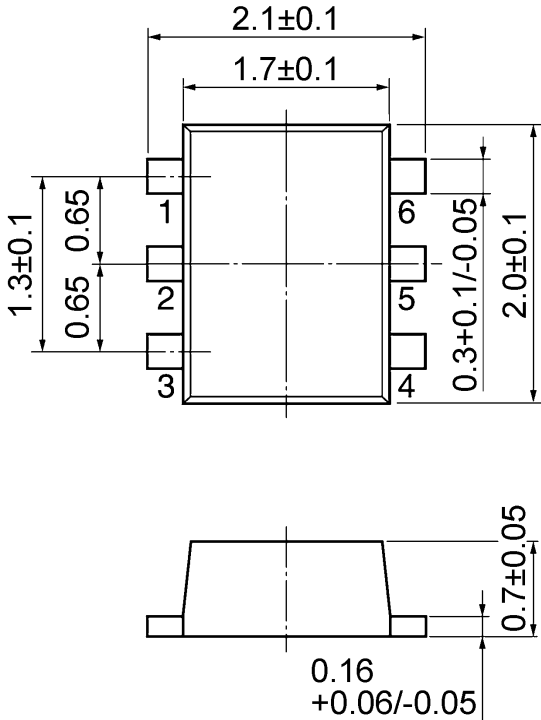

Weight: 0.007 g (typ.)

## Package Dimensions

S-WFBGA6-0102-0.40A01

“Unit : mm”

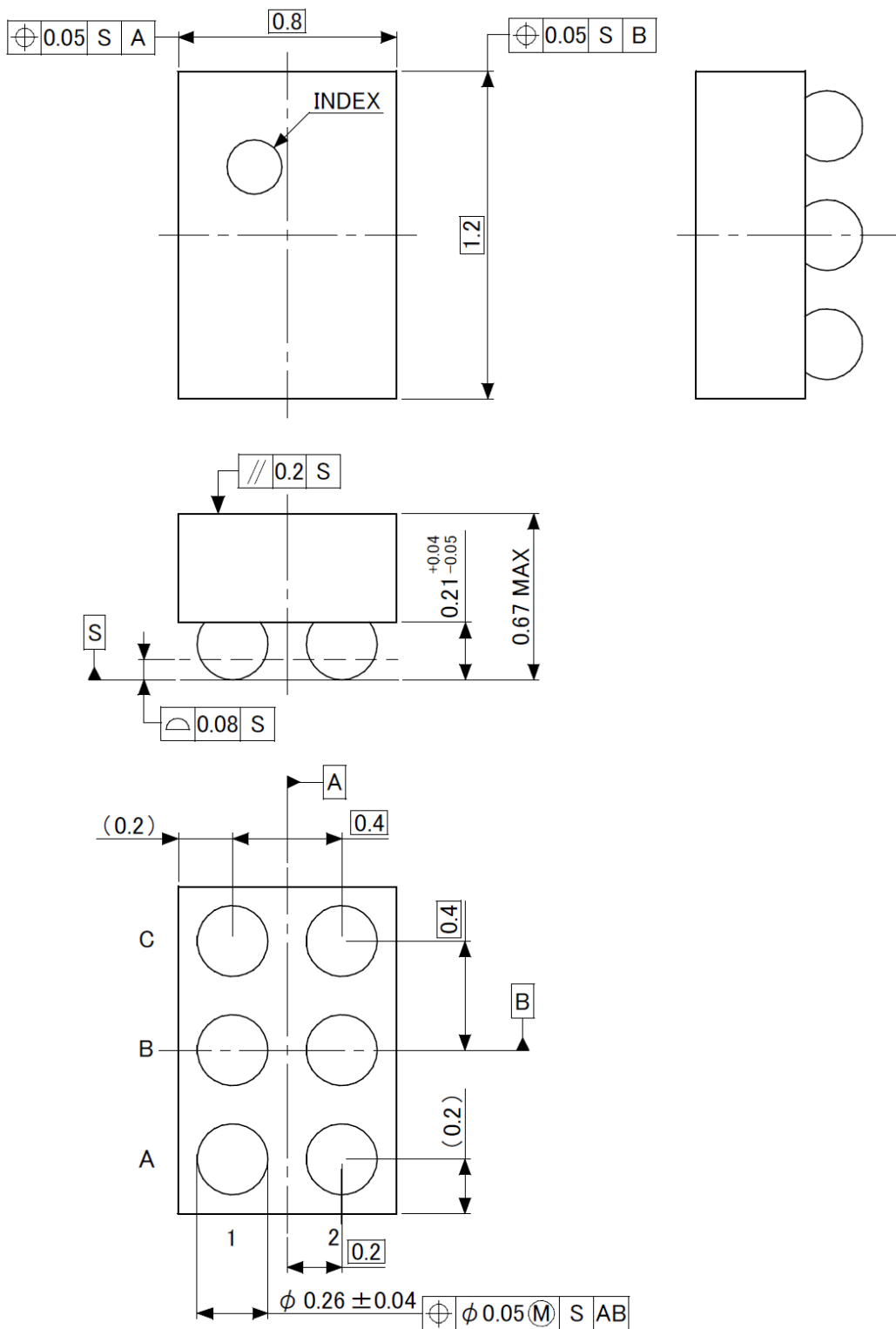

Weight: 0.001 g (typ.)

The resins used in this product include no flame retardants.

## RESTRICTIONS ON PRODUCT USE

- Toshiba Corporation, and its subsidiaries and affiliates (collectively "TOSHIBA"), reserve the right to make changes to the information in this document, and related hardware, software and systems (collectively "Product") without notice.
- This document and any information herein may not be reproduced without prior written permission from TOSHIBA. Even with TOSHIBA's written permission, reproduction is permissible only if reproduction is without alteration/omission.
- Though TOSHIBA works continually to improve Product's quality and reliability, Product can malfunction or fail. Customers are responsible for complying with safety standards and for providing adequate designs and safeguards for their hardware, software and systems which minimize risk and avoid situations in which a malfunction or failure of Product could cause loss of human life, bodily injury or damage to property, including data loss or corruption. Before customers use the Product, create designs including the Product, or incorporate the Product into their own applications, customers must also refer to and comply with (a) the latest versions of all relevant TOSHIBA information, including without limitation, this document, the specifications, the data sheets and application notes for Product and the precautions and conditions set forth in the "TOSHIBA Semiconductor Reliability Handbook" and (b) the instructions for the application with which the Product will be used with or for. Customers are solely responsible for all aspects of their own product design or applications, including but not limited to (a) determining the appropriateness of the use of this Product in such design or applications; (b) evaluating and determining the applicability of any information contained in this document, or in charts, diagrams, programs, algorithms, sample application circuits, or any other referenced documents; and (c) validating all operating parameters for such designs and applications. **TOSHIBA ASSUMES NO LIABILITY FOR CUSTOMERS' PRODUCT DESIGN OR APPLICATIONS.**
- **PRODUCT IS NEITHER INTENDED NOR WARRANTED FOR USE IN EQUIPMENTS OR SYSTEMS THAT REQUIRE EXTRAORDINARILY HIGH LEVELS OF QUALITY AND/OR RELIABILITY, AND/OR A MALFUNCTION OR FAILURE OF WHICH MAY CAUSE LOSS OF HUMAN LIFE, BODILY INJURY, SERIOUS PROPERTY DAMAGE AND/OR SERIOUS PUBLIC IMPACT ("UNINTENDED USE").** Except for specific applications as expressly stated in this document, Unintended Use includes, without limitation, equipment used in nuclear facilities, equipment used in the aerospace industry, medical equipment, equipment used for automobiles, trains, ships and other transportation, traffic signaling equipment, equipment used to control combustions or explosions, safety devices, elevators and escalators, devices related to electric power, and equipment used in finance-related fields. **IF YOU USE PRODUCT FOR UNINTENDED USE, TOSHIBA ASSUMES NO LIABILITY FOR PRODUCT.** For details, please contact your TOSHIBA sales representative.
- Do not disassemble, analyze, reverse-engineer, alter, modify, translate or copy Product, whether in whole or in part.
- Product shall not be used for or incorporated into any products or systems whose manufacture, use, or sale is prohibited under any applicable laws or regulations.
- The information contained herein is presented only as guidance for Product use. No responsibility is assumed by TOSHIBA for any infringement of patents or any other intellectual property rights of third parties that may result from the use of Product. No license to any intellectual property right is granted by this document, whether express or implied, by estoppel or otherwise.
- **ABSENT A WRITTEN SIGNED AGREEMENT, EXCEPT AS PROVIDED IN THE RELEVANT TERMS AND CONDITIONS OF SALE FOR PRODUCT, AND TO THE MAXIMUM EXTENT ALLOWABLE BY LAW, TOSHIBA (1) ASSUMES NO LIABILITY WHATSOEVER, INCLUDING WITHOUT LIMITATION, INDIRECT, CONSEQUENTIAL, SPECIAL, OR INCIDENTAL DAMAGES OR LOSS, INCLUDING WITHOUT LIMITATION, LOSS OF PROFITS, LOSS OF OPPORTUNITIES, BUSINESS INTERRUPTION AND LOSS OF DATA, AND (2) DISCLAIMS ANY AND ALL EXPRESS OR IMPLIED WARRANTIES AND CONDITIONS RELATED TO SALE, USE OF PRODUCT, OR INFORMATION, INCLUDING WARRANTIES OR CONDITIONS OF MERCHANTABILITY, FITNESS FOR A PARTICULAR PURPOSE, ACCURACY OF INFORMATION, OR NONINFRINGEMENT.**
- Do not use or otherwise make available Product or related software or technology for any military purposes, including without limitation, for the design, development, use, stockpiling or manufacturing of nuclear, chemical, or biological weapons or missile technology products (mass destruction weapons). Product and related software and technology may be controlled under the applicable export laws and regulations including, without limitation, the Japanese Foreign Exchange and Foreign Trade Law and the U.S. Export Administration Regulations. Export and re-export of Product or related software or technology are strictly prohibited except in compliance with all applicable export laws and regulations.
- Please contact your TOSHIBA sales representative for details as to environmental matters such as the RoHS compatibility of Product. Please use Product in compliance with all applicable laws and regulations that regulate the inclusion or use of controlled substances, including without limitation, the EU RoHS Directive. **TOSHIBA ASSUMES NO LIABILITY FOR DAMAGES OR LOSSES OCCURRING AS A RESULT OF NONCOMPLIANCE WITH APPLICABLE LAWS AND REGULATIONS.**