

General Description

The MIC94066-69 are dual high-side load switches designed for operation between 1.7V to 5.5V. The devices contain a pair of low on-resistance, 115mΩ(max) P-channel MOSFETs that support over 2A of continuous current. The MIC94067 and MIC94069 feature an active load discharge circuit which insures capacitive loads retain no charge when the main switch is in an OFF state.

An active pull-down on the enable input keeps MIC94066-69 in a default OFF state until the EN pin is pulled to a high level. The built-in level shift circuitry allows for a logic signal that may be different from the supply voltage to switch the high-side P-channel MOSFET on or off.

MIC94066-67 feature rapid turn on while MIC94068-69 provide a slew rate controlled Soft-Start turn-on of 800μs (typical) to prevent in-rush current from glitching supply rails.

MIC94066-69's voltage range makes them suitable for 1-cell Lithium ion and 2- to 3-cell NiMH/NiCad/Alkaline powered systems, as well as all 5V applications. Their low operating current of 2μA and low shutdown current of <1μA maximize battery life.

Data sheets and support documentation can be found on Micrel's web site at www.micrel.com.

Features

- 1.7V to 5.5V input voltage range
- 2A continuous operating current
- 85mΩ (typ) R_{ON}
- Built-in level shift for control logic; can be operated by 1.5V logic.
- Low 2μA quiescent current
- Soft-Start: MIC94068-69
- Micro-power shutdown <1μA
- Load discharge circuit: MIC94067, MIC94069
- Space saving 2mm x 2mm MFL™

Applications

- Load switch in portable applications:
 - Cellular phones
 - PDAs
 - MP3 players
 - Digital Cameras
 - Portable instrumentation
- Battery switch-over circuits
- Level translators

Typical Application

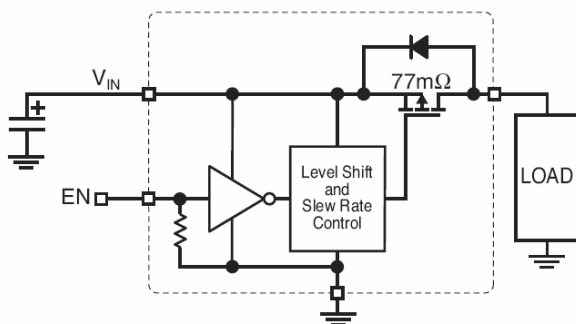

½ MIC94066, 68
Load Switch Application

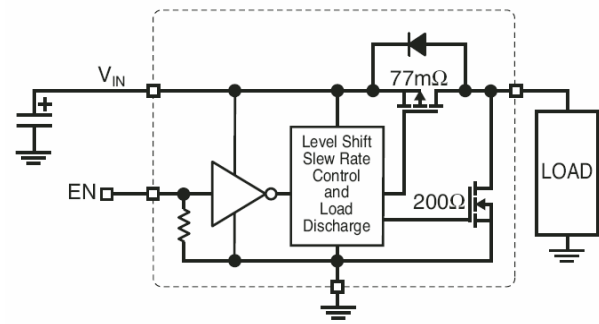

½ MIC94067, 69
Load Switch with Capacitive Load Discharge

Ordering Information

Part Number	Part Marking*	Soft-Start	Load Discharge	Pb-Free Package
MIC94066YML	$\overline{P66}$			2x2 mm MLF™
MIC94067YML	$\overline{P67}$		•	
MIC94068YML	$\overline{P68}$	•		
MIC94069YML	$\overline{P69}$	•	•	

* Note: Over bar symbol may not be to scale

Pin Configuration

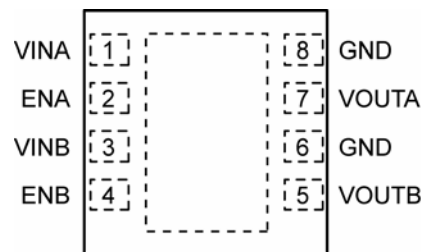

Top View
2x2 mm MLF™ (code)

Pin Description

Pin Number	Pin Name	Pin Function
1	V _{IN A}	Source of P-channel MOSFET.
2	EN A	Enable (Input): Active-high CMOS compatible control input for switch A. Do not leave floating.
3	V _{IN B}	Source of P-channel MOSFET.
4	EN B	Enable (Input): Active-high CMOS compatible control input for switch A. Do not leave floating.
5	V _{OUT B}	Drain of P-channel MOSFET.
6	GND	Ground. Both ground pins must be grounded.
7	V _{OUT A}	Drain of P-channel MOSFET.
8	GND	Ground. Both ground pins must be grounded.

Absolute Maximum Ratings⁽¹⁾

Input Voltage (V _{IN})	+6V
Enable Voltage (V _{EN})	+6V
Continuous Drain Current (I _D) ⁽³⁾	
T _A = 25°C	±2A
T _A = 85°C	±1.4A
Pulsed Drain Current (I _{DP}) ⁽⁴⁾	±6A
Continuous Diode Current (I _S) ⁽⁴⁾	-50mA
Storage Temperature (T _S)	-55°C to +150°C
EDS Rating – HBM ⁽⁶⁾	4KV

Operating Ratings⁽²⁾

Input Voltage (V _{IN})	+1.7 to +5.5V
Junction Temperature (T _A)	-40°C to +125°C
Package Thermal Resistance	
2x2 MLF (Θ _{JA})	90°C/W
2x2 MLF (Θ _{JC}) ⁽³⁾	45°C/W

Electrical Characteristics

V_{IN} = 5V; T_A = 25°C, bold values indicate -40°C ≤ T_A ≤ +85°C, unless noted.

Symbol	Parameter	Condition	Min	Typ	Max	Units
V _{EN_TH}	Enable Threshold Voltage	V _{IN} = 1.8V to 4.5V, I _D = -250μA	0.5		1.2	V
		V _{IN} = 1.7V to 4.5V, I _D = -250μA	0.4		1.2	V
I _{EN}	Enable Input Current	V _{IN} = V _{EN} = 5.5V		2	4	μA
I _{VIN}	OFF State Leakage Current	V _{IN} = +5.5V, V _{EN} = 0V			1	μA
R _{D_S(ON)}	P-Channel Drain to Source On Resistance	V _{IN} = +4.5V, I _D = -100mA, V _{EN} = 1.5V		85	115	mΩ
		V _{IN} = +3.6V, I _D = -100mA, V _{EN} = 1.5V		100	140	mΩ
		V _{IN} = +2.5V, I _D = -100mA, V _{EN} = 1.5V		145	200	mΩ
		V _{IN} = +1.8V, I _D = -100mA, V _{EN} = 1.5V		155	215	mΩ
		V _{IN} = +1.7V, I _D = -100mA, V _{EN} = 1.5V		165	225	mΩ
R _{SHUTDOWN}	Turn-off Impedance	V _{IN} = +3.6V, I _{TEST} = 1mA, V _{EN} = 0V MIC94067, 69		200	300	Ω

Dynamic

Symbol	Parameter	Condition	Min	Typ	Max	Units
t _{ON_DLY}	Turn-On Delay Time	V _{IN} = +3.6V, I _D = -100mA, V _{EN} = 1.5V MIC94066, 67		0.85	1.5	μs
		V _{IN} = +3.6V, I _D = -100mA, V _{EN} = 1.5V MIC94068, 69		700	1200	μs
t _{ON_RISE}	Turn-On Rise Time	V _{IN} = +3.6V, I _D = -100mA, V _{EN} = 1.5V MIC94066, 67	0.5	1	5	μs
		V _{IN} = +3.6V, I _D = -100mA, V _{EN} = 1.5V MIC94068, 69	500	800	1500	μs
t _{OFF_DLY}	Turn-Off Delay Time	V _{IN} = +3.6V, I _D = -100mA, V _{EN} = 1.5V MIC94066, 67		115	200	ns
		V _{IN} = +3.6V, I _D = -100mA, V _{EN} = 1.5V MIC94068, 69		100	200	ns

Dynamic (cont.)

$t_{\text{OFF_FALL}}$	Turn-Off Fall Time	$V_{\text{IN}} = +3.6\text{V}$, $I_{\text{D}} = -100\text{mA}$, $V_{\text{EN}} = 1.5\text{V}$ MIC94066, 67		60	100	ns
		$V_{\text{IN}} = +3.6\text{V}$, $I_{\text{D}} = -100\text{mA}$, $V_{\text{EN}} = 1.5\text{V}$ MIC94068, 69		60	100	ns

Notes:

1. Exceeding the absolute maximum rating may damage the device.
2. The device is not guaranteed to function outside its operating rating.
3. With backside thermal contact to PCB.
4. Pulse width $< 300\mu\text{s}$ with $< 2\%$ duty cycle.
5. Continuous body diode current conduction (reverse conduction, i.e. V_{OUT} to V_{IN}) is not recommended.
6. Devices are ESD sensitive. Handling precautions recommended. HBM (Human body model), 1.5k in series with 100pF.

Typical Characteristics

$R_L = 100\text{mA}$, $C_L = 0\mu\text{F}$ for the following plots

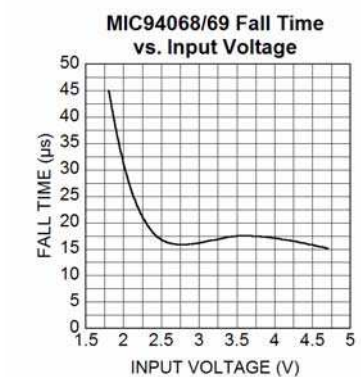
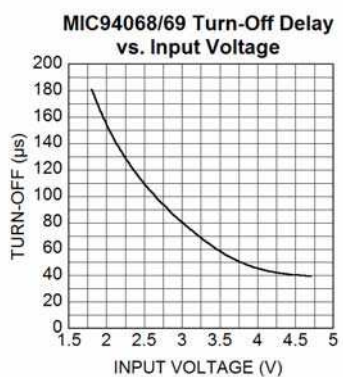
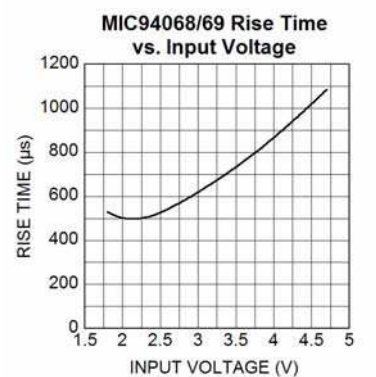
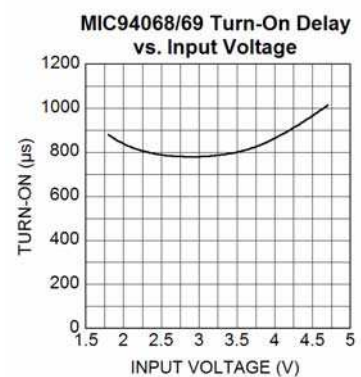
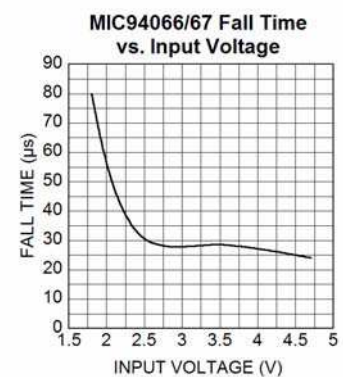
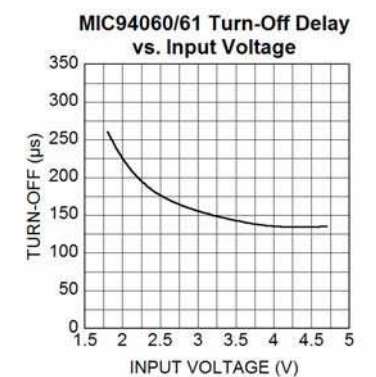
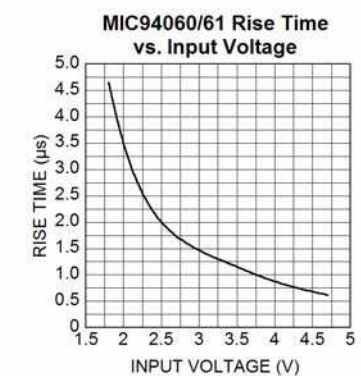
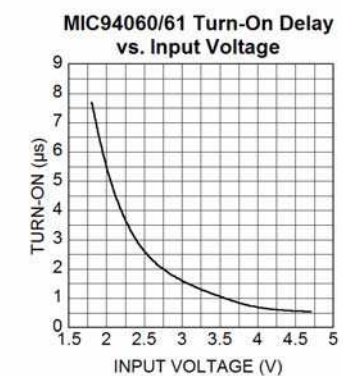
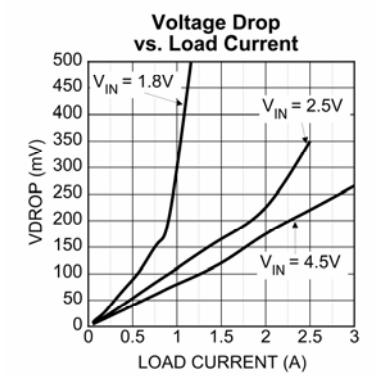
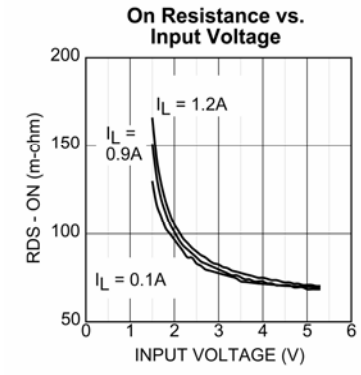
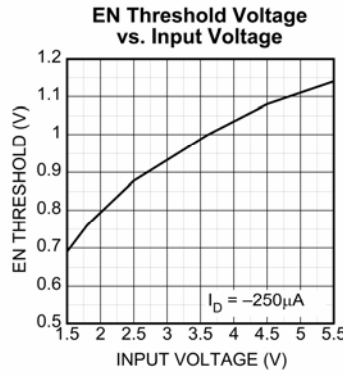
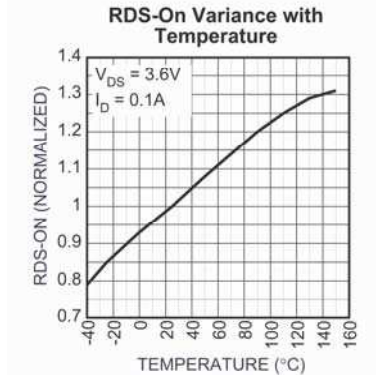

Functional Characteristics

MIC94066

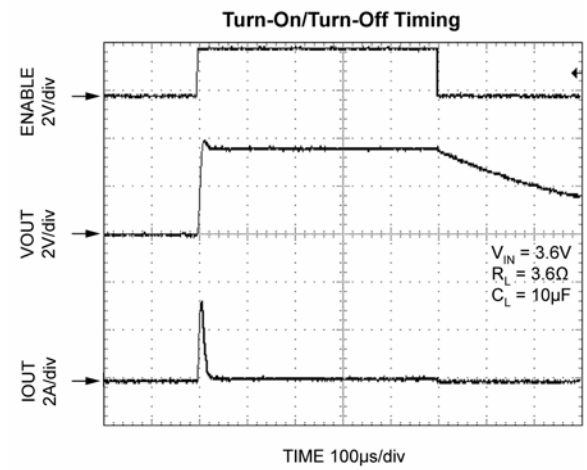
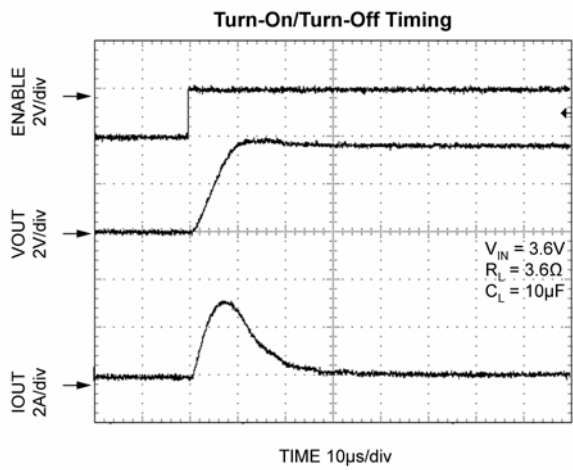
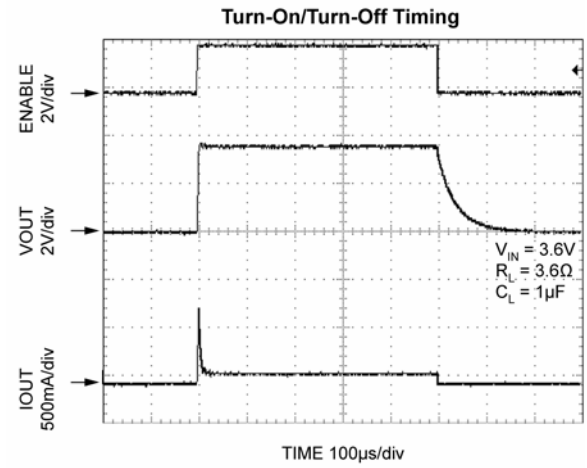
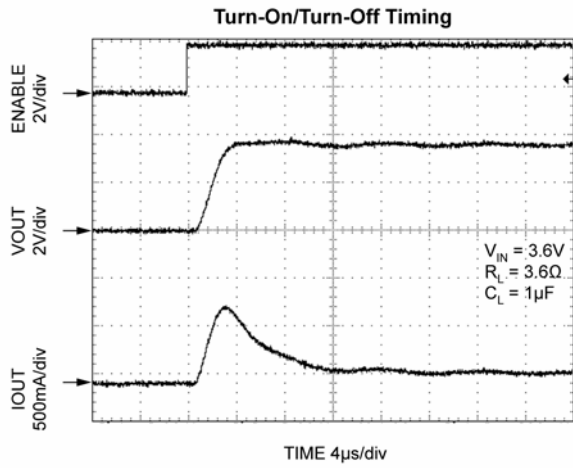

MIC94067

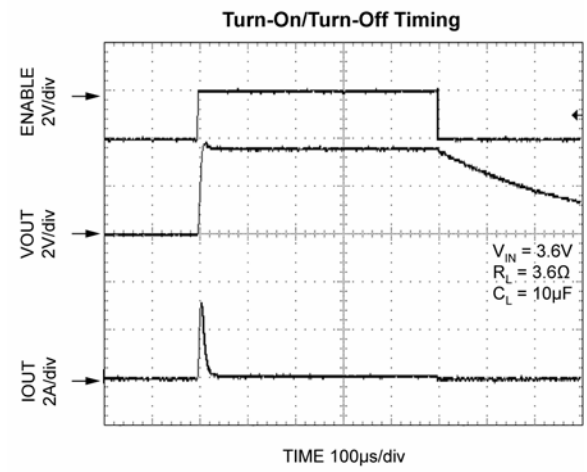
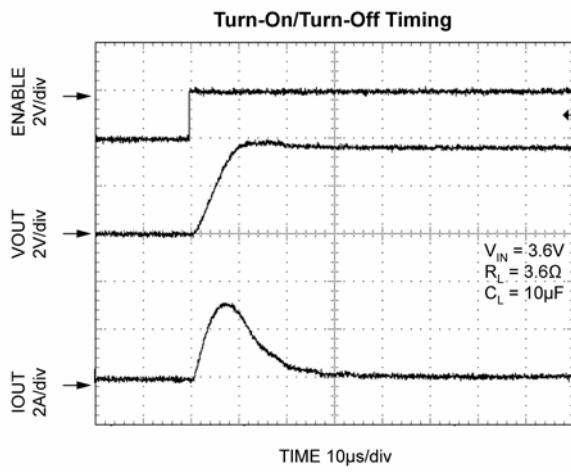
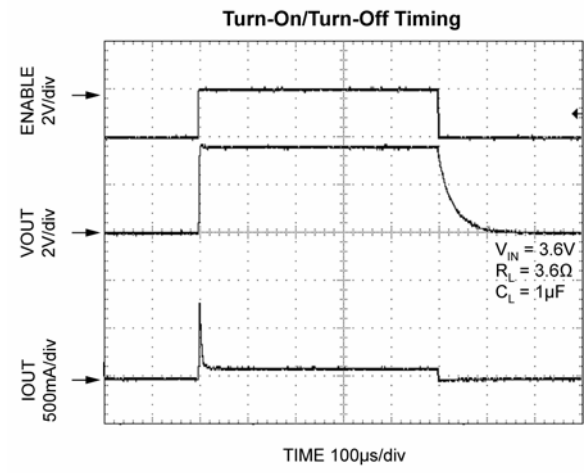
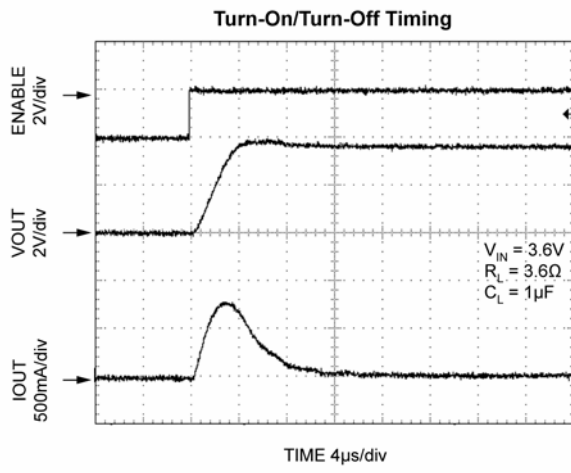

MIC94068

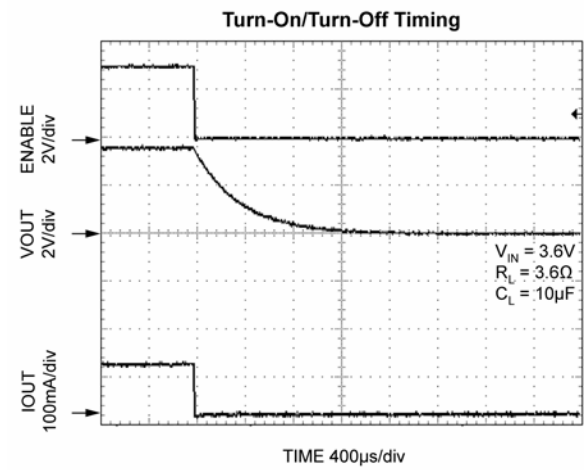
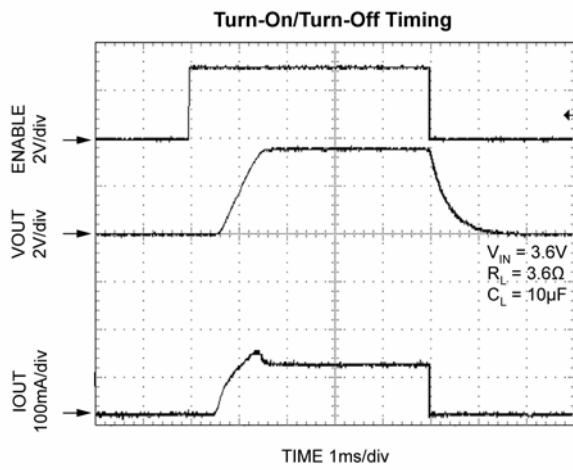
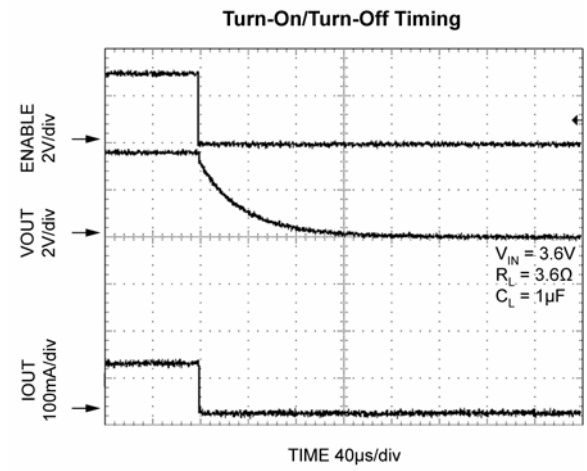
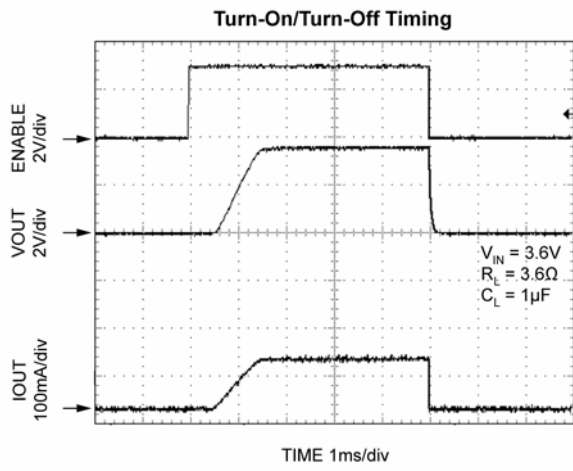

MIC94069

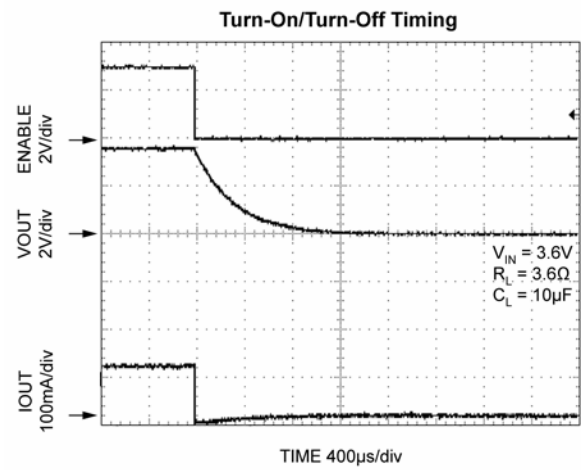
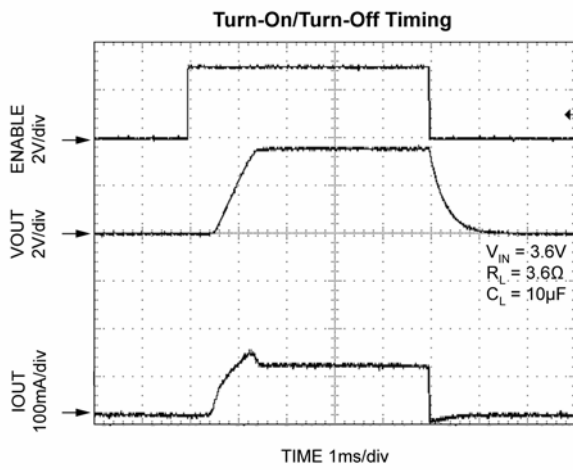
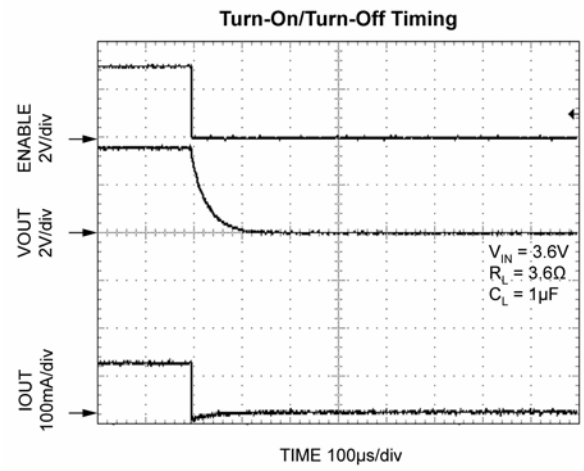
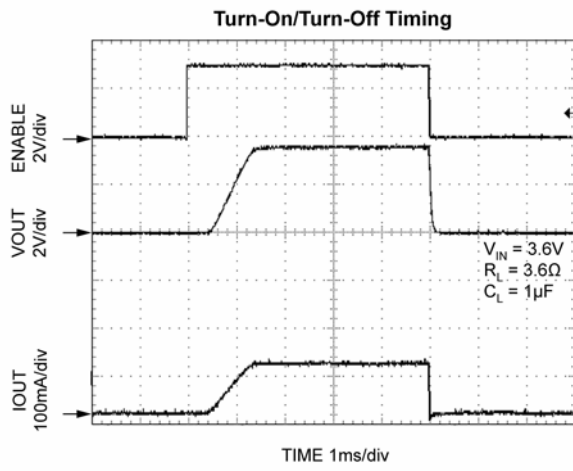

Package Information

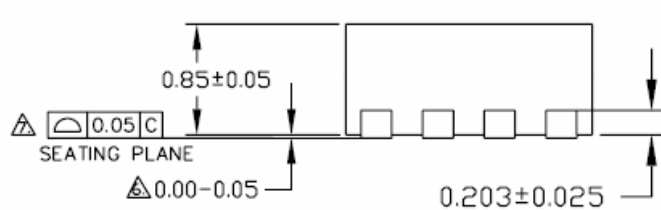
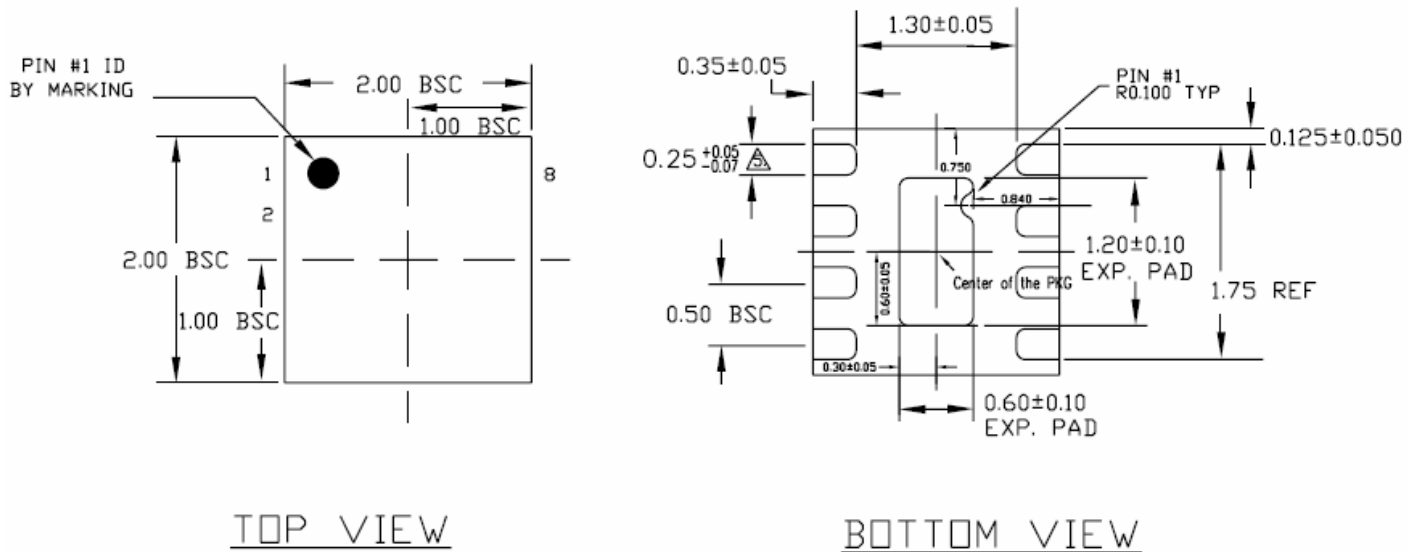

- NOTE:
1. ALL DIMENSIONS ARE IN MILLIMETERS.
 2. MAX. PACKAGE WARPAGE IS 0.05 mm.
 3. MAXIMUM ALLOWABLE BURRS IS 0.076 mm IN ALL DIRECTIONS.
 4. PIN #1 ID ON TOP WILL BE LASER/INK MARKED.
- △ DIMENSION APPLIES TO METALIZED TERMINAL AND IS MEASURED BETWEEN 0.20 AND 0.25 mm FROM TERMINAL TIP.
- △ APPLIED ONLY FOR TERMINALS.
- △ APPLIED FOR EXPOSED PAD AND TERMINALS.

MICREL, INC. 2180 FORTUNE DRIVE SAN JOSE, CA 95131 USA
 TEL +1 (408) 944-0800 FAX +1 (408) 474-1000 WEB <http://www.micrel.com>

The information furnished by Micrel in this data sheet is believed to be accurate and reliable. However, no responsibility is assumed by Micrel for its use. Micrel reserves the right to change circuitry and specifications at any time without notification to the customer.

Micrel Products are not designed or authorized for use as components in life support appliances, devices or systems where malfunction of a product can reasonably be expected to result in personal injury. Life support devices or systems are devices or systems that (a) are intended for surgical implant into the body or (b) support or sustain life, and whose failure to perform can be reasonably expected to result in a significant injury to the user. A Purchaser's use or sale of Micrel Products for use in life support appliances, devices or systems is a Purchaser's own risk and Purchaser agrees to fully indemnify Micrel for any damages resulting from such use or sale.

© 2006 Micrel, Incorporated.