

Operational Amplifiers

# Low Supply Current Input/Output Full Swing Operational Amplifier

BD12730G BD12732xxx BD12734xxx

**General Description**

BD12730G/BD12732xxx/BD12734xxx are input/output full swing operational amplifiers. They have the features of low operating supply voltage, low supply current, low input referred noise voltage and high phase margin. These are suitable for audio applications and battery management.

**Features**

- Low Operating Supply Voltage
- Input/Output Full Swing
- Low Supply Current
- High Phase Margin
- Low Input Referred Noise Voltage

**Applications**

- Audio Application
- Battery Management
- General Purpose

**Key Specifications**

- Operating Supply Voltage (Single Supply): +1.8V to +5.5V
- Operating Temperature Range: -40°C to +85°C
- Input Offset Voltage: 5mV (Max)
- Supply Current:
  - BD12730G(Single) 550µA (Max)
  - BD12732xxx(Dual) 900µA (Max)
  - BD12734xxx(Quad) 1800µA (Max)
- Input Referred Noise Voltage: 10 nV/√Hz (Typ)
- Adequate Phase Margin: 75°(Typ)

**Packages**

	W(Typ) x D(Typ) x H(Max)
SSOP5	2.90mm x 2.80mm x 1.25mm
SOP8	5.00mm x 6.20mm x 1.71mm
SOP-J8	4.90mm x 6.00mm x 1.65mm
SSOP-B8	3.00mm x 6.40mm x 1.35mm
TSSOP-B8	3.00mm x 6.40mm x 1.20mm
MSOP8	2.90mm x 4.00mm x 0.90mm
TSSOP-B8J	3.00mm x 4.90mm x 1.10mm
SOP14	8.70mm x 6.20mm x 1.71mm
SOP-J14	8.65mm x 6.00mm x 1.65mm
SSOP-B14	5.00mm x 6.40mm x 1.35mm
TSSOP-B14J	5.00mm x 6.40mm x 1.20mm

**Pin Configuration**

BD12730G : SSOP5

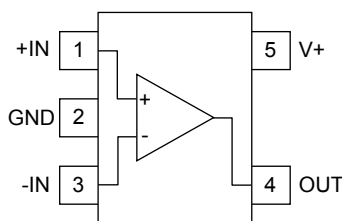

Pin No.	Pin Name
1	+IN
2	GND
3	-IN
4	OUT
5	V+

○Product structure : Silicon monolithic integrated circuit ○This product has no designed protection against radioactive rays.

BD12732F : SOP8  
 BD12732FJ : SOP-J8  
 BD12732FV : SSOP-B8  
 BD12732FVT : TSSOP-B8  
 BD12732FVM : MSOP8  
 BD12732FVJ : TSSOP-B8J

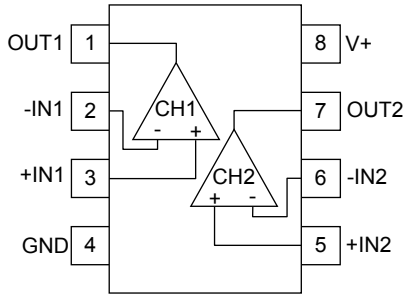

Pin No.	Pin Name
1	OUT1
2	-IN1
3	+IN1
4	GND
5	+IN2
6	-IN2
7	OUT2
8	V+

BD12734F : SOP14  
 BD12734FJ : SOP-J14  
 BD12734FV : SSOP-B14  
 BD12734FVJ : TSSOP-B14J

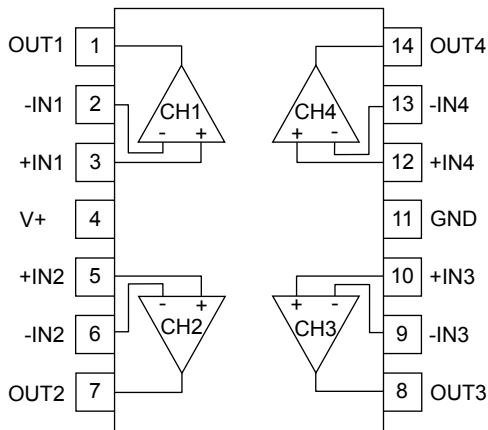

Pin No.	Pin Name
1	OUT1
2	-IN1
3	+IN1
4	V+
5	+IN2
6	-IN2
7	OUT2
8	OUT3
9	-IN3
10	+IN3
11	GND
12	+IN4
13	-IN4
14	OUT4

Ordering Information

B D 1 2 7 3 x x x x -

x x

Part Number

BD12730G  
 BD12732xxx  
 BD12734xxx

Package

G : SSOP5  
 F : SOP8  
 FJ : SOP-J8  
 FV : SSOP-B8  
 FVT : TSSOP-B8  
 FVM : MSOP8  
 FVJ : TSSOP-B8J  
 F : SOP14  
 FJ : SOP-J14  
 FV : SSOP-B14  
 FVJ : TSSOP-B14J

Packaging and Forming Specification

TR: Embossed tape and reel  
 (SSOP5/MSOP8)  
 E2: Embossed tape and reel  
 (SOP8/SOP-J8/SSOP-B8/TSSOP-B8/  
 TSSOP-B8J/SOP14/SOP-J14/SSOP-B14/  
 TSSOP-B14J)

## Line-up

Operating Temperature	Channels	Package		Orderable Part Number
-40°C to +85°C	1ch	SSOP5	Reel of 3000	BD12730G-TR
	2ch	SOP8	Reel of 2500	BD12732F-E2
		SOP-J8	Reel of 2500	BD12732FJ-E2
		SSOP-B8	Reel of 2500	BD12732FV-E2
		TSSOP-B8	Reel of 3000	BD12732FVT-E2
		MSOP8	Reel of 3000	BD12732FVM-TR
		TSSOP-B8J	Reel of 2500	BD12732FVJ-E2
	4ch	SOP14	Reel of 2500	BD12734F-E2
		SOP-J14	Reel of 2500	BD12734FJ-E2
		SSOP-B14	Reel of 2500	BD12734FV-E2
		TSSOP-B14J	Reel of 2500	BD12734FVJ-E2

Absolute Maximum Ratings (T<sub>A</sub>=25°C)

Parameter	Symbol	Rating			Unit
		BD12730G	BD12732xxx	BD12734xxx	
Supply Voltage	V+	+7.0			V
Power Dissipation	P <sub>D</sub>	SSOP5	0.67 (Note 1,9)	-	-
		SOP8	-	0.68 (Note 2,9)	-
		SOP-J8	-	0.67 (Note 1,9)	-
		SSOP-B8	-	0.62 (Note 3,9)	-
		TSSOP-B8	-	0.62 (Note 3,9)	-
		MSOP8	-	0.58 (Note 4,9)	-
		TSSOP-B8J	-	0.58 (Note 4,9)	-
		SOP14	-	-	0.56 (Note 5,9)
		SOP-J14	-	-	1.02 (Note 6,9)
		SSOP-B14	-	-	0.87 (Note 7,9)
TSSOP-B14J	-	-	0.85 (Note 8,9)		
Differential Input Voltage (Note 10)	V <sub>ID</sub>	±3.0			V
Input Common-mode Voltage Range	V <sub>ICM</sub>	GND to V+			V
Input Current (Note 11)	I <sub>I</sub>	±10			mA
Operating Supply Voltage	V <sub>opr</sub>	+1.8 to +5.5			V
Operating Temperature	T <sub>opr</sub>	- 40 to +85			°C
Storage Temperature	T <sub>stg</sub>	- 55 to +150			°C
Maximum Junction Temperature	T <sub>Jmax</sub>	+150			°C

(Note 1) To use at temperature above T<sub>A</sub>=25°C, reduce by 5.4mW/°C.

(Note 2) To use at temperature above T<sub>A</sub>=25°C, reduce by 5.5mW/°C.

(Note 3) To use at temperature above T<sub>A</sub>=25°C, reduce by 5.0mW/°C.

(Note 4) To use at temperature above T<sub>A</sub>=25°C, reduce by 4.7mW/°C.

(Note 5) To use at temperature above T<sub>A</sub>=25°C, reduce by 4.5mW/°C.

(Note 6) To use at temperature above T<sub>A</sub>=25°C, reduce by 8.2mW/°C.

(Note 7) To use at temperature above T<sub>A</sub>=25°C, reduce by 7.0mW/°C.

(Note 8) To use at temperature above T<sub>A</sub>=25°C, reduce by 6.8mW/°C.

(Note 9) Mounted on a FR4 glass epoxy PCB 70mm×70mm×1.6mm (Copper foil area less than 3%).

(Note 10) Differential Input Voltage is the voltage difference between the inverting and non-inverting inputs. The input pin voltage is set to more than GND.

(Note 11) An excessive input current will flow when input voltages of more than Supply Voltage(V+)+0.6V or less than GND-0.6V are applied. The input current can be set to less than the rated current by adding a limiting resistor.

Caution: Operating the IC over the absolute maximum ratings may damage the IC. The damage can either be a short circuit between pins or an open circuit between pins and the internal circuitry. Therefore, it is important to consider circuit protection measures, such as adding a fuse, in case the IC is operated over the absolute maximum ratings.

## Electrical Characteristics

OBD12730G (Unless otherwise specified V+=+5V, GND=0V, T<sub>A</sub>=25°C)

Parameter	Symbol	Limit			Unit	Conditions
		Min	Typ	Max		
Supply Current	I <sub>DD</sub>	-	320	550	μA	R <sub>L</sub> =∞, +IN=2.5V
Input Offset Voltage <sup>(Note 12)</sup>	V <sub>IO</sub>	-	1	5	mV	-
Input Bias Current <sup>(Note 12)</sup>	I <sub>B</sub>	-	50	250	nA	-
Input Offset Current <sup>(Note 12)</sup>	I <sub>IO</sub>	-	5	100	nA	-
Large Signal Voltage Gain	A <sub>V</sub>	60	85	-	dB	R <sub>L</sub> =2kΩ <sup>(Note 13)</sup>
Common-mode Rejection Ratio	CMRR	55	70	-	dB	-
Power Supply Rejection Ratio	PSRR	70	85	-	dB	-
Maximum Output Voltage (High)	V <sub>OH1</sub>	4.9	4.95	-	V	R <sub>L</sub> =20kΩ <sup>(Note 13)</sup>
	V <sub>OH2</sub>	4.75	4.85	-	V	R <sub>L</sub> =2kΩ <sup>(Note 13)</sup>
Maximum Output Voltage (Low)	V <sub>OL1</sub>	-	0.05	0.1	V	R <sub>L</sub> =20kΩ <sup>(Note 13)</sup>
	V <sub>OL2</sub>	-	0.15	0.25	V	R <sub>L</sub> =2kΩ <sup>(Note 13)</sup>
Output Source Current	I <sub>SOURCE</sub>	-	12	-	mA	OUT=0V
Output Sink Current	I <sub>SINK</sub>	-	5	-	mA	OUT=5V
Input Common-mode Voltage Range	V <sub>ICM</sub>	0	-	5	V	CMRR>55dB
Gain Bandwidth	GBW	-	1	-	MHz	f=10kHz
Unity Gain Frequency	f <sub>T</sub>	-	1	-	MHz	R <sub>L</sub> =2kΩ <sup>(Note 13)</sup>
Phase Margin	θ	-	75	-	deg	R <sub>L</sub> =2kΩ <sup>(Note 13)</sup>
Input Referred Noise Voltage	V <sub>N</sub>	-	10	-	nV/√Hz	f=1kHz
		-	1.2	-	μVrms	R <sub>s</sub> =100Ω, DIN-AUDIO
Slew Rate	SR	-	0.4	-	V/μS	R <sub>L</sub> =2kΩ <sup>(Note 13)</sup>

(Note 12) Absolute value

(Note 13) Output load resistance connect to a half of V+

## Electrical Characteristics – continued

OBD12732xxx (Unless otherwise specified V+=+5V, GND=0V, T<sub>A</sub>=25°C)

Parameter	Symbol	Limit			Unit	Conditions
		Min	Typ	Max		
Supply Current	I <sub>DD</sub>	-	580	900	μA	R <sub>L</sub> =∞, +IN=2.5V All Op-Amps
Input Offset Voltage <sup>(Note 14)</sup>	V <sub>IO</sub>	-	1	5	mV	-
Input Bias Current <sup>(Note 14)</sup>	I <sub>B</sub>	-	50	250	nA	-
Input Offset Current <sup>(Note 14)</sup>	I <sub>IO</sub>	-	5	100	nA	-
Large Signal Voltage Gain	A <sub>v</sub>	60	85	-	dB	R <sub>L</sub> =2kΩ <sup>(Note 15)</sup>
Common-mode Rejection Ratio	CMRR	55	70	-	dB	-
Power Supply Rejection Ratio	PSRR	70	85	-	dB	-
Maximum Output Voltage (High)	V <sub>OH1</sub>	4.9	4.95	-	V	R <sub>L</sub> =20kΩ <sup>(Note 15)</sup>
	V <sub>OH2</sub>	4.75	4.85	-	V	R <sub>L</sub> =2kΩ <sup>(Note 15)</sup>
Maximum Output Voltage (Low)	V <sub>OL1</sub>	-	0.05	0.1	V	R <sub>L</sub> =20kΩ <sup>(Note 15)</sup>
	V <sub>OL2</sub>	-	0.15	0.25	V	R <sub>L</sub> =2kΩ <sup>(Note 15)</sup>
Output Source Current	I <sub>SOURCE</sub>	-	12	-	mA	OUT=0V
Output Sink Current	I <sub>SINK</sub>	-	5	-	mA	OUT=5V
Input Common-mode Voltage Range	V <sub>ICM</sub>	0	-	5	V	CMRR>55dB
Gain Bandwidth	GBW	-	1	-	MHz	f=10kHz
Unity Gain Frequency	f <sub>T</sub>	-	1	-	MHz	R <sub>L</sub> =2kΩ <sup>(Note 15)</sup>
Phase Margin	θ	-	75	-	deg	R <sub>L</sub> =2kΩ <sup>(Note 15)</sup>
Input Referred Noise Voltage	V <sub>N</sub>	-	10	-	nV/√Hz	f=1kHz
		-	1.2	-	μVrms	R <sub>S</sub> =100Ω, DIN-AUDIO
Slew Rate	SR	-	0.4	-	V/μS	R <sub>L</sub> =2kΩ <sup>(Note 15)</sup>
Channel Separation	CS	-	90	-	dB	f=1kHz, R <sub>L</sub> =2kΩ <sup>(Note 15)</sup> OUT=1.2Vrms

(Note 14) Absolute value

(Note 15) Output load resistance connect to a half of V+

## Electrical Characteristics – continued

OBD12734xxx (Unless otherwise specified V+=+5V, GND=0V, T<sub>A</sub>=25°C)

Parameter	Symbol	Limit			Unit	Conditions
		Min	Typ	Max		
Supply Current	I <sub>DD</sub>	-	1200	1800	μA	R <sub>L</sub> =∞, +IN=2.5V All Op-Amps
Input Offset Voltage <sup>(Note 16)</sup>	V <sub>IO</sub>	-	1	5	mV	-
Input Bias Current <sup>(Note 16)</sup>	I <sub>B</sub>	-	50	250	nA	-
Input Offset Current <sup>(Note 16)</sup>	I <sub>IO</sub>	-	5	100	nA	-
Large Signal Voltage Gain	A <sub>V</sub>	60	85	-	dB	R <sub>L</sub> =2kΩ <sup>(Note 17)</sup>
Common-mode Rejection Ratio	CMRR	55	70	-	dB	-
Power Supply Rejection Ratio	PSRR	70	85	-	dB	-
Maximum Output Voltage (High)	V <sub>OH1</sub>	4.9	4.95	-	V	R <sub>L</sub> =20kΩ <sup>(Note 17)</sup>
	V <sub>OH2</sub>	4.75	4.85	-	V	R <sub>L</sub> =2kΩ <sup>(Note 17)</sup>
Maximum Output Voltage (Low)	V <sub>OL1</sub>	-	0.05	0.1	V	R <sub>L</sub> =20kΩ <sup>(Note 17)</sup>
	V <sub>OL2</sub>	-	0.15	0.25	V	R <sub>L</sub> =2kΩ <sup>(Note 17)</sup>
Output Source Current	I <sub>SOURCE</sub>	-	12	-	mA	OUT=0V
Output Sink Current	I <sub>SINK</sub>	-	5	-	mA	OUT=5V
Input Common-mode Voltage Range	V <sub>ICM</sub>	0	-	5	V	CMRR>55dB
Gain Bandwidth	GBW	-	1	-	MHz	f=10kHz
Unity Gain Frequency	f <sub>T</sub>	-	1	-	MHz	R <sub>L</sub> =2kΩ <sup>(Note 17)</sup>
Phase Margin	θ	-	75	-	deg	R <sub>L</sub> =2kΩ <sup>(Note 17)</sup>
Input Referred Noise Voltage	V <sub>N</sub>	-	10	-	nV/√Hz	f=1kHz
		-	1.2	-	μVrms	R <sub>S</sub> =100Ω, DIN-AUDIO
Slew Rate	SR	-	0.4	-	V/μS	R <sub>L</sub> =2kΩ <sup>(Note 17)</sup>
Channel Separation	CS	-	133	-	dB	f=1kHz, R <sub>L</sub> =2kΩ <sup>(Note 17)</sup> OUT=1.2Vrms

(Note 16) Absolute value

(Note 17) Output load resistance connect to a half of V+

## Description of electrical characteristics

Described here are the terms of electric characteristics used in this datasheet. Items and symbols used are also shown. Note that item name, symbol and their meaning may differ from those on other manufacturer's document or general documents.

### 1. Absolute maximum ratings

Absolute maximum rating items indicate the condition which must not be exceeded. Application of voltage in excess of absolute maximum rating or use out of absolute maximum rated temperature environment may cause deterioration of characteristics.

- (1) Supply Voltage ( $V_{+}/GND$ )  
Indicates the maximum voltage that can be applied between the  $V_{+}$  terminal and GND terminal without deterioration or destruction of characteristics of internal circuit.
- (2) Differential Input Voltage ( $V_{ID}$ )  
Indicates the maximum voltage that can be applied between non-inverting and inverting terminals without damaging the IC.
- (3) Input Common-mode Voltage Range ( $V_{ICM}$ )  
Indicates the maximum voltage that can be applied to the non-inverting and inverting terminals without deterioration or destruction of electrical characteristics. Input common-mode voltage range of the maximum ratings does not assure normal operation of IC. For normal operation, use the IC within the input common-mode voltage range characteristics.
- (4) Power Dissipation ( $P_D$ )  
Indicates the power that can be consumed by the IC when mounted on a specific board at the ambient temperature 25°C (normal temperature). As for package product,  $P_D$  is determined by the temperature that can be permitted by the IC in the package (maximum junction temperature) and the thermal resistance of the package.

### 2. Electrical characteristics

- (1) Supply Current ( $I_{DD}$ )  
Indicates the current that flows within the IC under specified no-load conditions.
- (2) Input Offset Voltage ( $V_{IO}$ )  
Indicates the voltage difference between non-inverting terminal and inverting terminals. It can be translated into the input voltage difference required for setting the output voltage at 0 V.
- (3) Input Bias Current ( $I_B$ )  
Indicates the current that flows into or out of the input terminal. It is defined by the average of input bias currents at the non-inverting and inverting terminals.
- (4) Input Offset Current ( $I_{IO}$ )  
Indicates the difference of input bias current between the non-inverting and inverting terminals.
- (5) Large Signal Voltage Gain ( $A_V$ )  
Indicates the amplifying rate (gain) of output voltage against the voltage difference between non-inverting terminal and inverting terminal. It is normally the amplifying rate (gain) with reference to DC voltage.  
 $A_V = (\text{Output voltage}) / (\text{Differential Input voltage})$
- (6) Common-mode Rejection Ratio (CMRR)  
Indicates the ratio of fluctuation of input offset voltage when the input common mode voltage is changed. It is normally the fluctuation of DC.  
 $CMRR = (\text{Change of Input common-mode voltage}) / (\text{Input offset fluctuation})$
- (7) Power Supply Rejection Ratio (PSRR)  
Indicates the ratio of fluctuation of input offset voltage when supply voltage is changed.  
It is normally the fluctuation of DC.  
 $PSRR = (\text{Change of power supply voltage}) / (\text{Input offset fluctuation})$
- (8) Maximum Output Voltage (High/Low Level Output Voltage) ( $V_{OH}/V_{OL}$ )  
Indicates the voltage range of the output under specified load condition. It is typically divided into maximum output voltage high and low. Maximum output voltage high indicates the upper limit of output voltage. Maximum output voltage low indicates the lower limit.
- (9) Output Source Current/ Output Sink Current ( $I_{SOURCE} / I_{SINK}$ )  
The maximum current that can be output from the IC under specific output conditions. The output source current indicates the current flowing out from the IC, and the output sink current indicates the current flowing into the IC.
- (10) Input Common-mode Voltage Range ( $V_{ICM}$ )  
Indicates the input voltage range where IC normally operates.
- (11) Gain Bandwidth (GBW)  
The product of the open-loop voltage gain and the frequency at which the voltage gain decreases 6dB/octave.
- (12) Unity Gain Frequency ( $f_T$ )  
Indicates a frequency where the voltage gain of operational amplifier is 1.
- (13) Phase Margin ( $\theta$ )  
Indicates the margin of phase from 180 degree phase lag at unity gain frequency.
- (14) Input Referred Noise Voltage ( $V_N$ )  
Indicates a noise voltage generated inside the operational amplifier equivalent by ideal voltage source connected in series with input terminal.
- (15) Slew Rate (SR)  
Indicates the ratio of the change in output voltage with time when a step input signal is applied.
- (16) Channel Separation (CS)  
Indicates the fluctuation in the output voltage of the driven channel with reference to the change of output voltage of the channel which is not driven.

Typical Performance Curves

OBD12730G

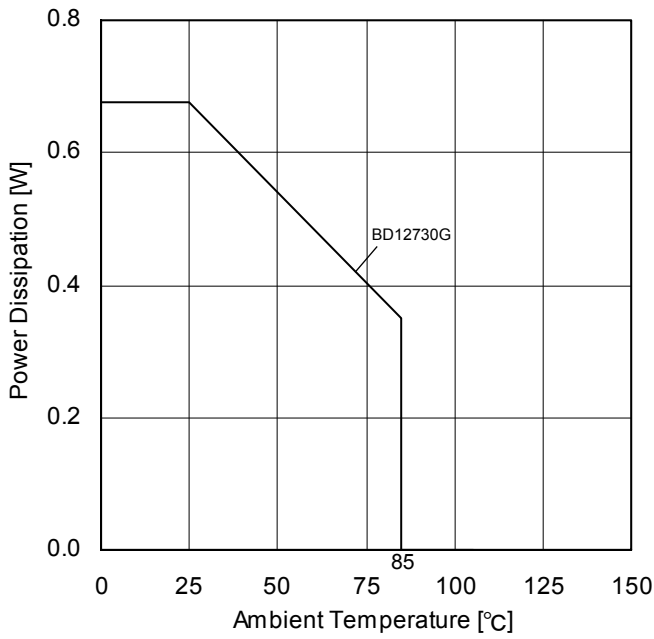

Figure 1.  
Power Dissipation vs Ambient Temperature  
(Derating Curve)

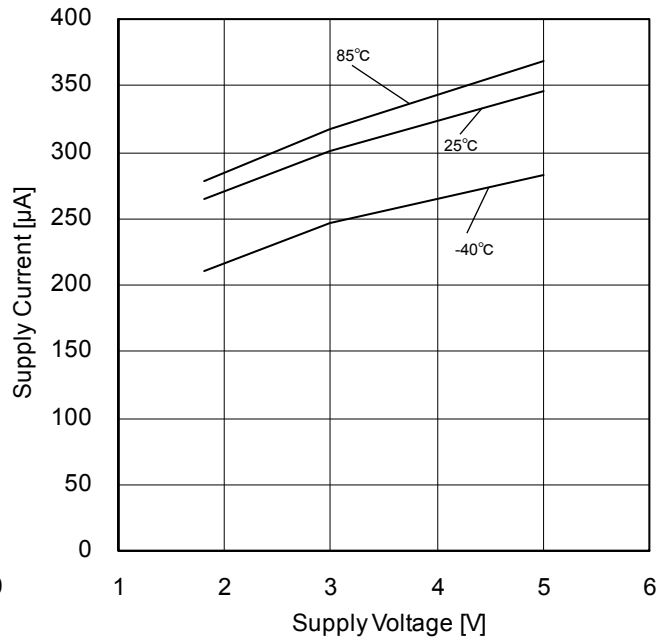

Figure 2.  
Supply Current vs Supply Voltage

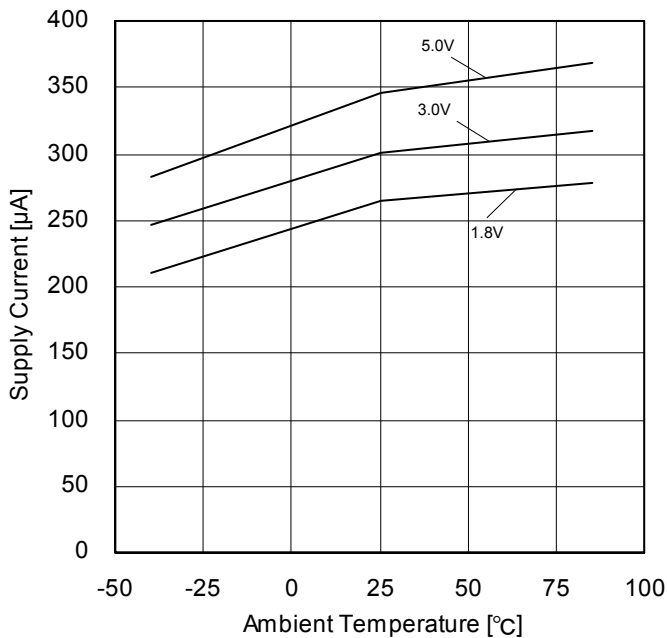

Figure 3.  
Supply Current vs Ambient Temperature

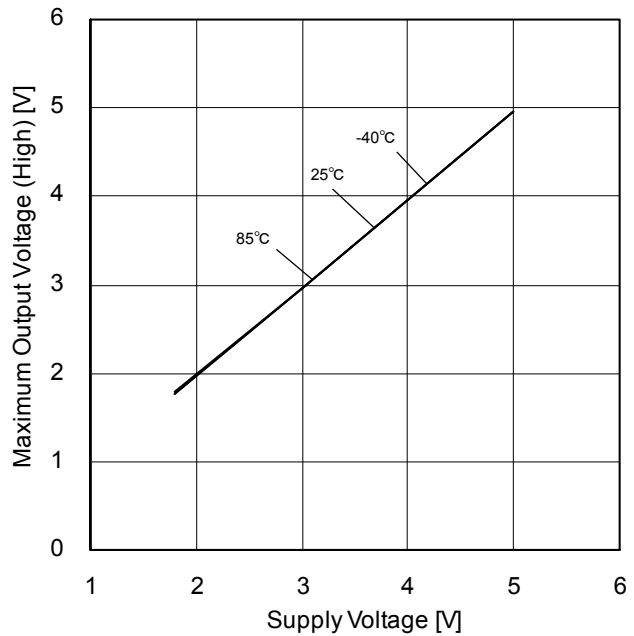

Figure 4.  
Maximum Output Voltage (High) vs Supply Voltage  
( $R_L=20k\Omega$ )

(\*)The data above are measurement values of typical sample, it is not guaranteed.



Typical Performance Curves – Continued

OBD12730G

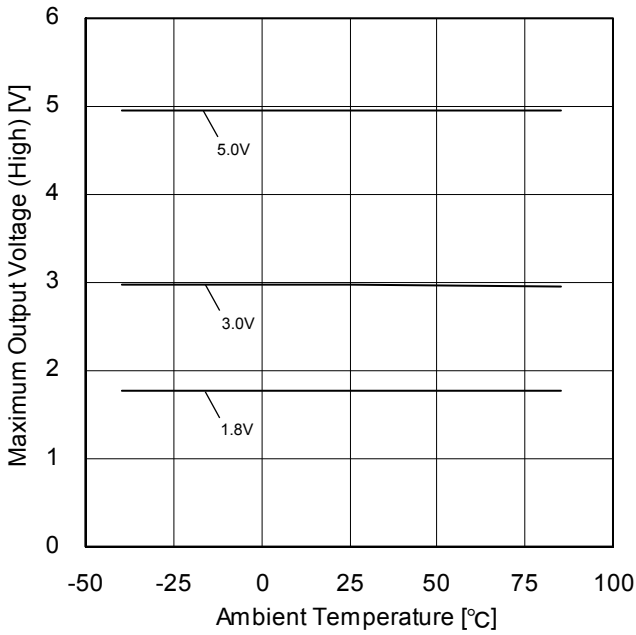

Figure 5.  
Maximum Output Voltage (High) vs Ambient Temperature  
( $R_L=20k\Omega$ )

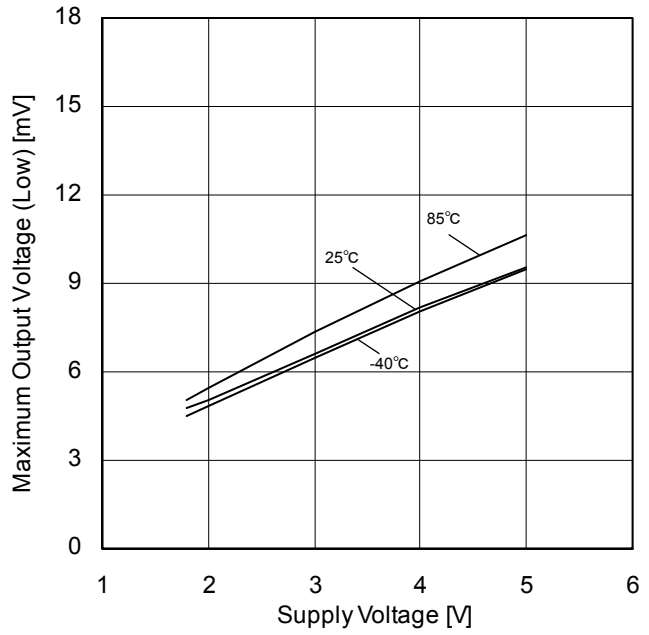

Figure 6.  
Maximum Output Voltage (Low) vs Supply Voltage  
( $R_L=20k\Omega$ )

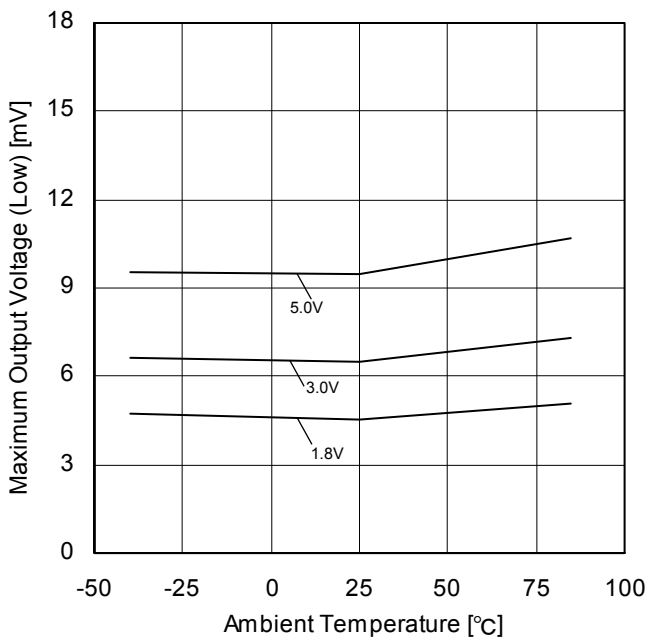

Figure 7.  
Maximum Output Voltage (Low) vs Ambient Temperature  
( $R_L=20k\Omega$ )

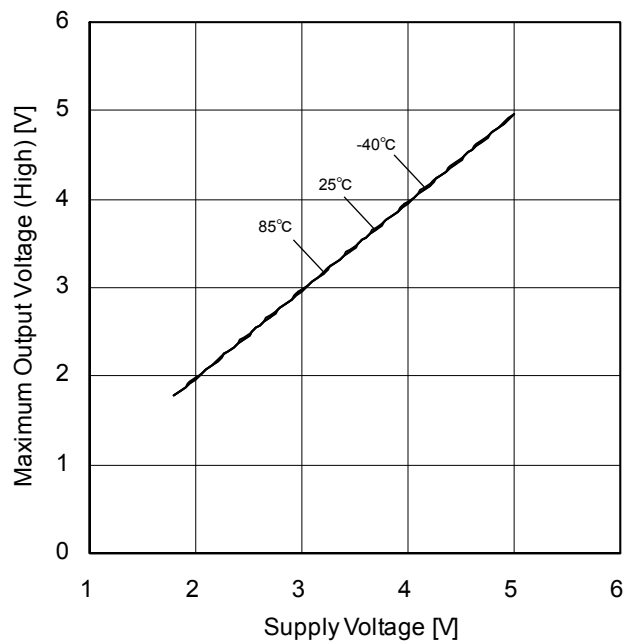

Figure 8.  
Maximum Output Voltage (High) vs Supply Voltage  
( $R_L=2k\Omega$ )

(\*)The data above are measurement values of typical sample, it is not guaranteed.

Typical Performance Curves – Continued

OBD12730G

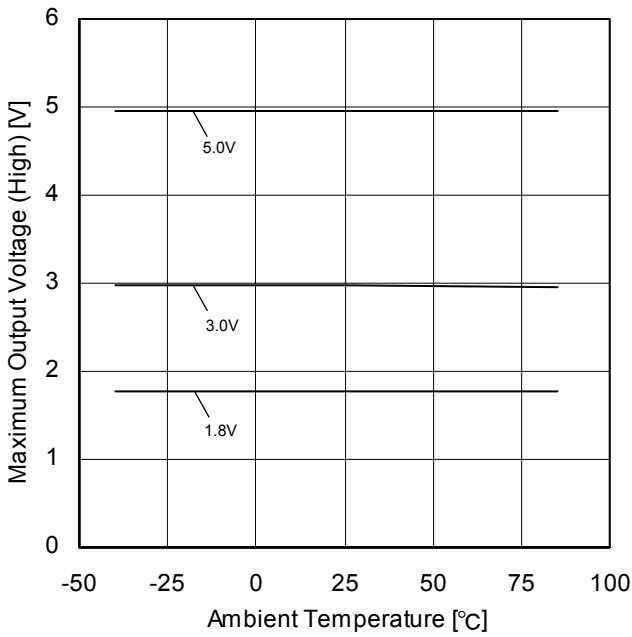

Figure 9.  
Maximum Output Voltage (High) vs Ambient Temperature  
( $R_L=2k\Omega$ )

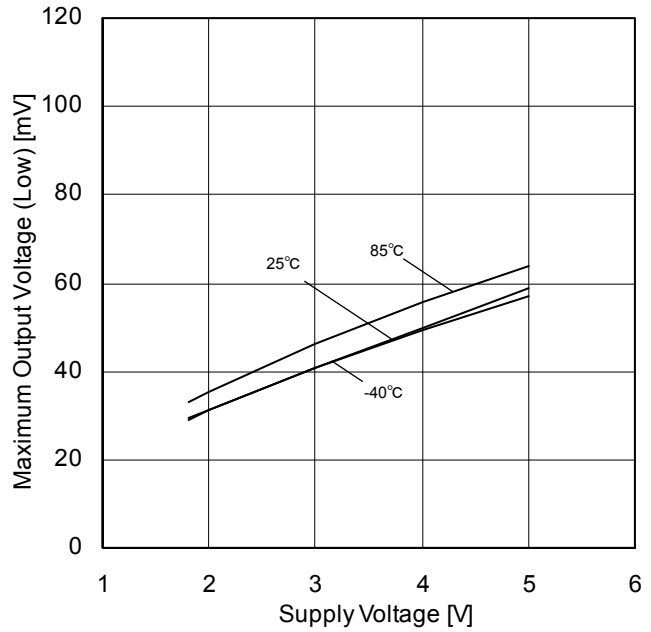

Figure 10.  
Maximum Output Voltage (Low) vs Supply Voltage  
( $R_L=2k\Omega$ )

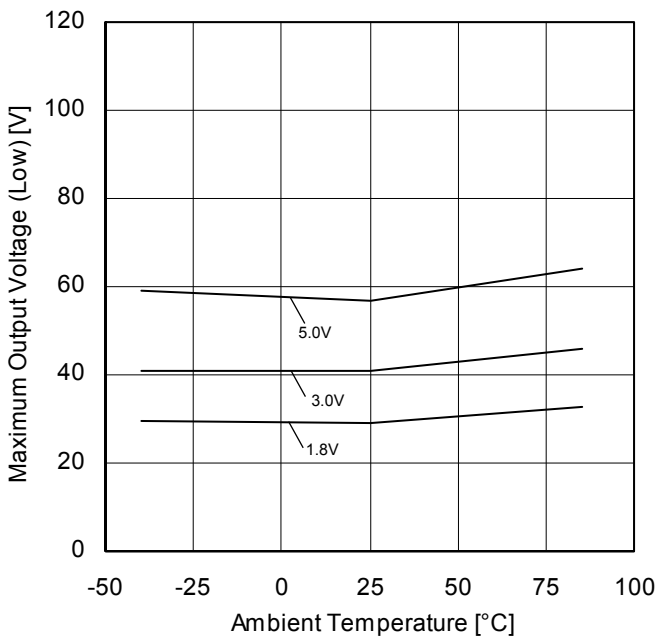

Figure 11.  
Maximum Output Voltage (Low) vs Ambient Temperature  
( $R_L=2k\Omega$ )

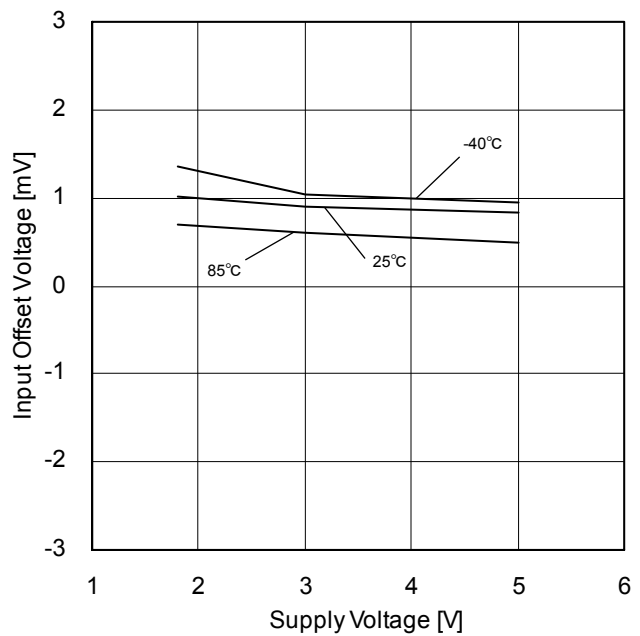

Figure 12.  
Input Offset Voltage vs Supply Voltage

(\*)The data above are measurement values of typical sample, it is not guaranteed.

Typical Performance Curves – Continued  
OBD12730G

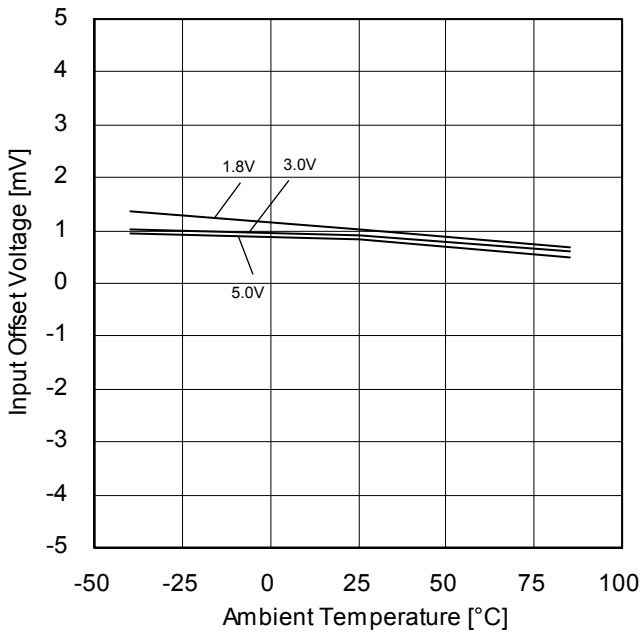

Figure 13.  
Input Offset Voltage vs Ambient Temperature

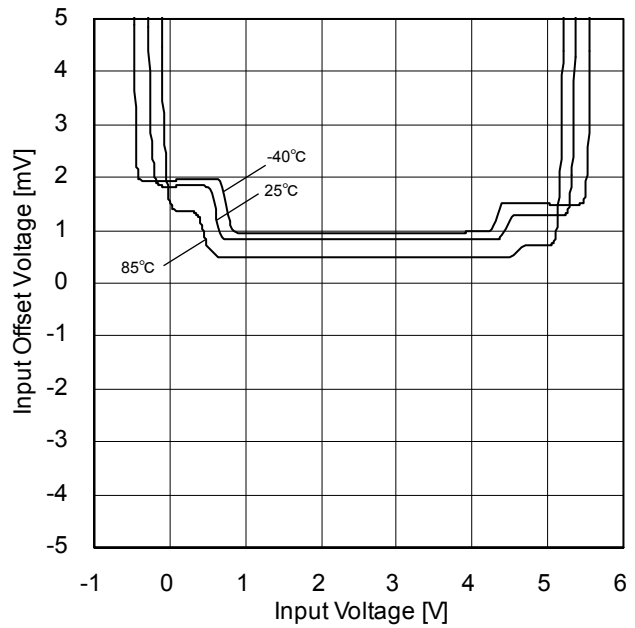

Figure 14.  
Input Common Mode Voltage Range  
(V+=5V)

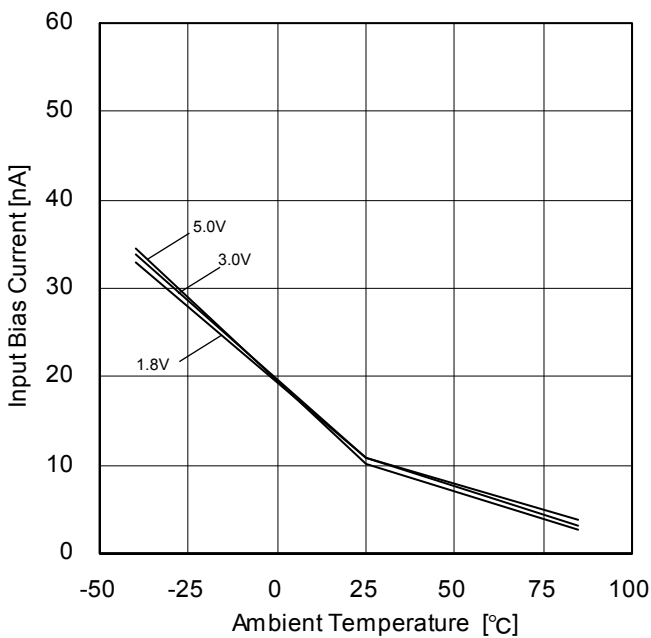

Figure 15.  
Input Bias Current vs Ambient Temperature

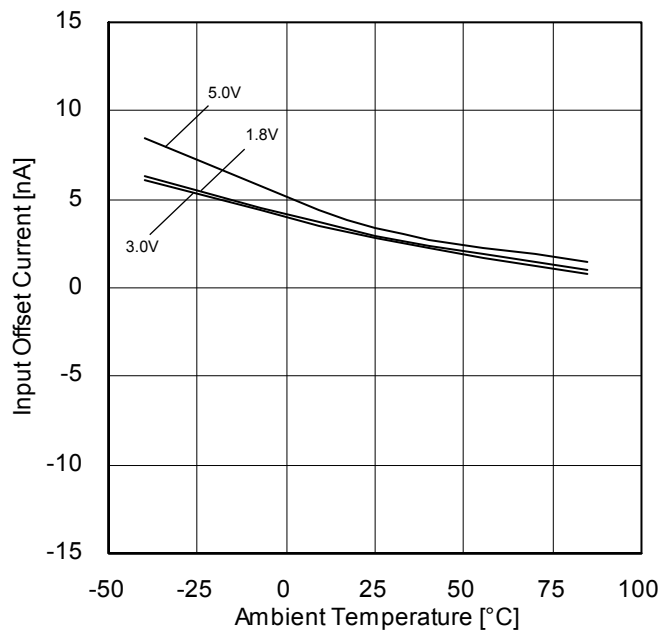

Figure 16.  
Input Offset Current vs Ambient Temperature

(\*)The data above are measurement values of typical sample, it is not guaranteed.

Typical Performance Curves – Continued

OBD12730G

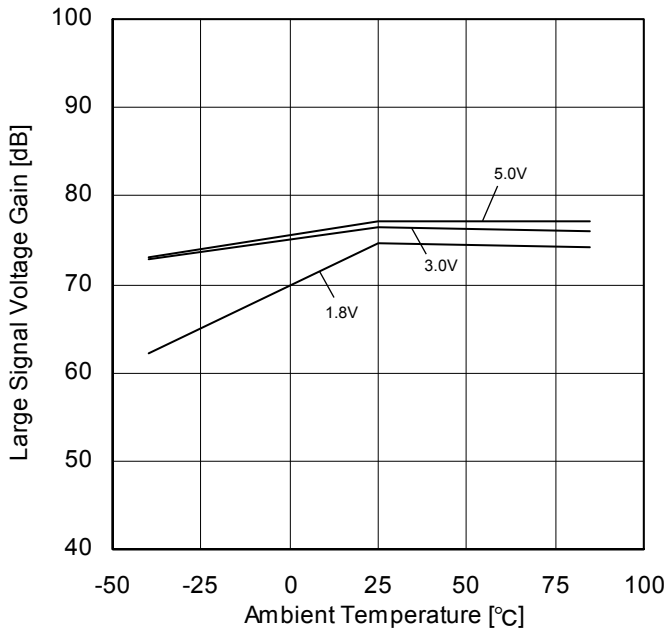

Figure 17.  
Large Signal Voltage Gain vs Ambient Temperature  
( $R_L=2k\Omega$ )

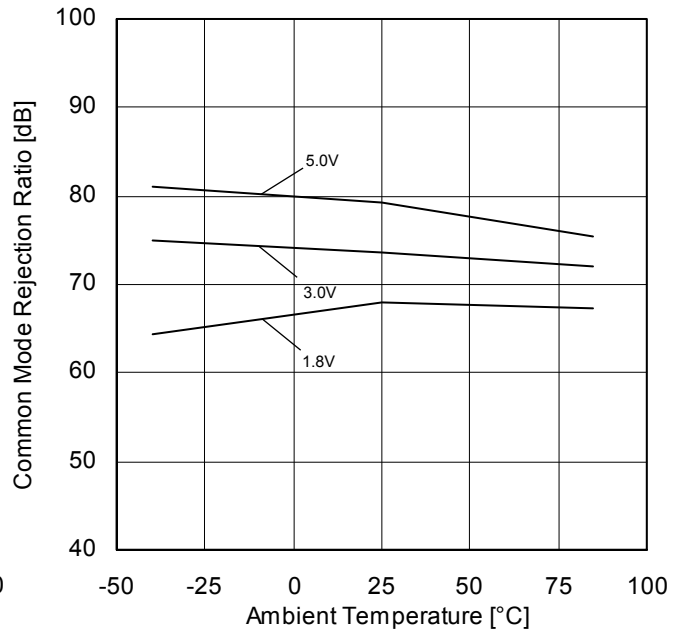

Figure 18.  
Common Mode Rejection Ratio vs Ambient Temperature

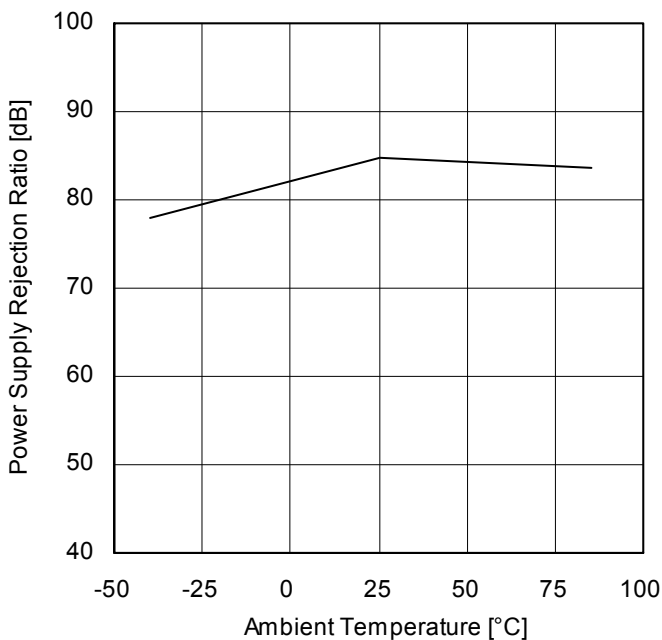

Figure 19.  
Power Supply Rejection Ratio vs Ambient Temperature  
( $V_+=1.8V$  to  $5.0V$ )

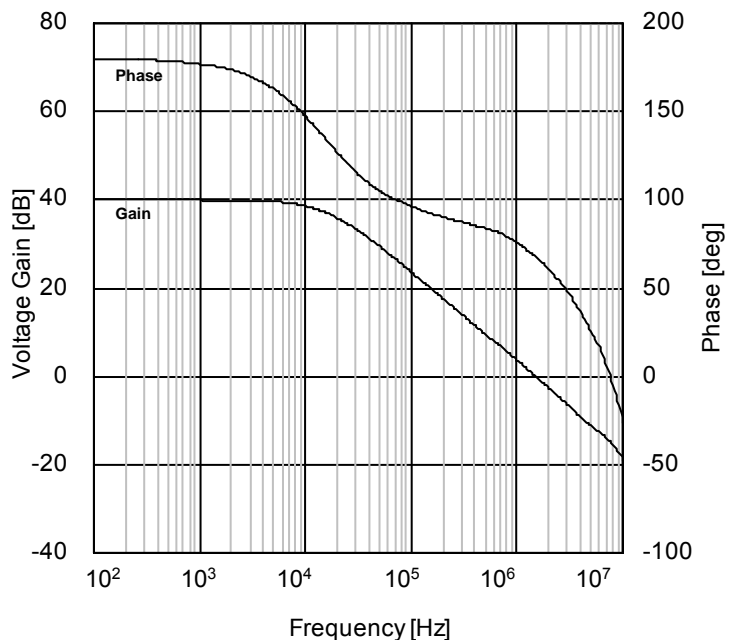

Figure 20.  
Voltage Gain · Phase vs Frequency  
( $V_+=5V$ ,  $R_L=2k\Omega$ ,  $T_A=25^\circ C$ )

(\*)The data above are measurement values of typical sample, it is not guaranteed.

Typical Performance Curves – Continued

OBD12730G

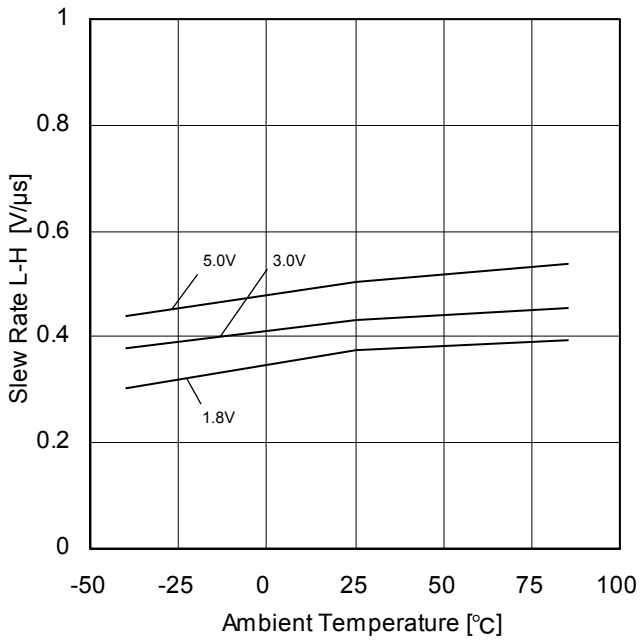

Figure 21.  
Slew Rate L-H vs Ambient Temperature  
( $R_L=2k\Omega$ )

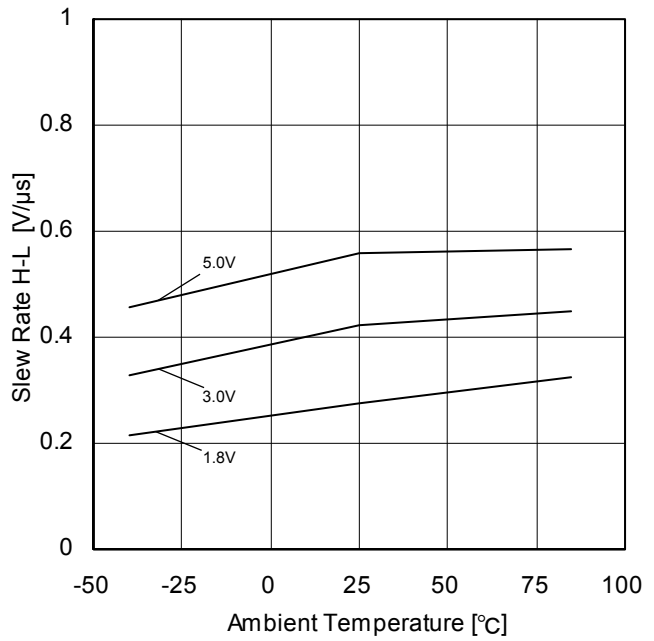

Figure 22.  
Slew Rate H-L vs Ambient Temperature  
( $R_L=2k\Omega$ )

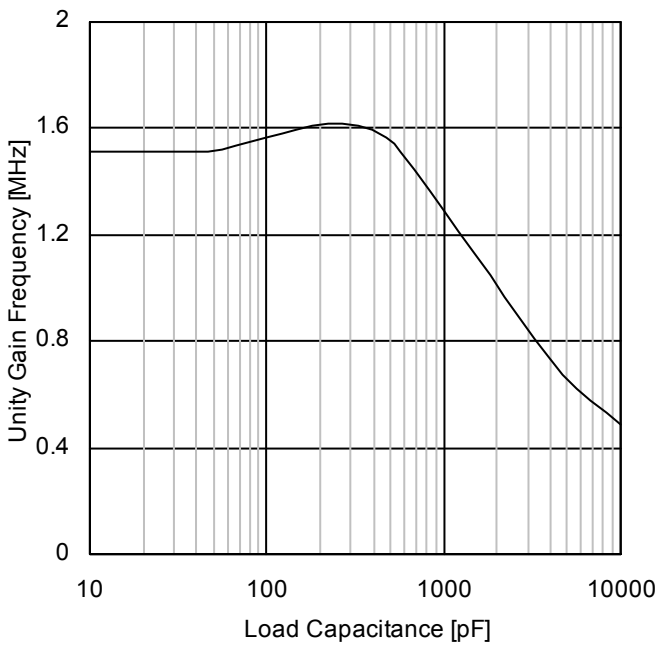

Figure 23.  
Unity Gain Frequency vs Load Capacitance  
( $V_+=5V, T_A=25^\circ C$ )

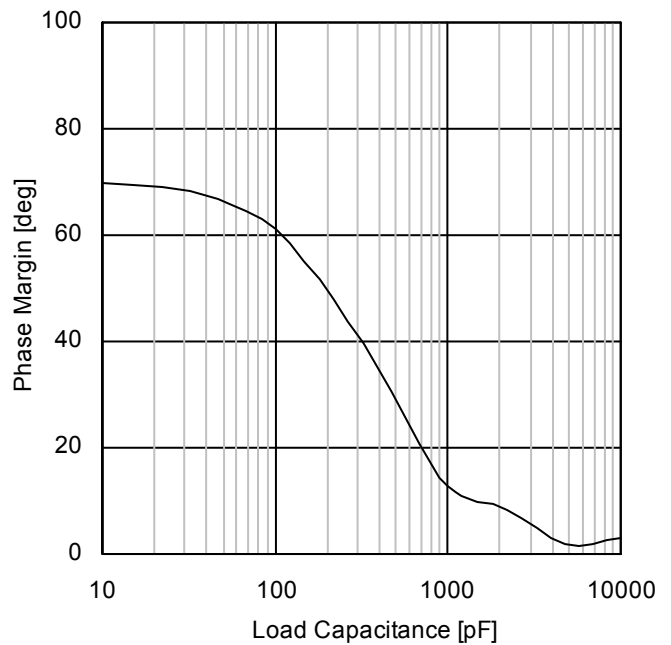

Figure 24.  
Phase Margin vs Load Capacitance  
( $V_+=5V, T_A=25^\circ C$ )

(\*)The data above are measurement values of typical sample, it is not guaranteed.

Typical Performance Curves – Continued

OBD12730G

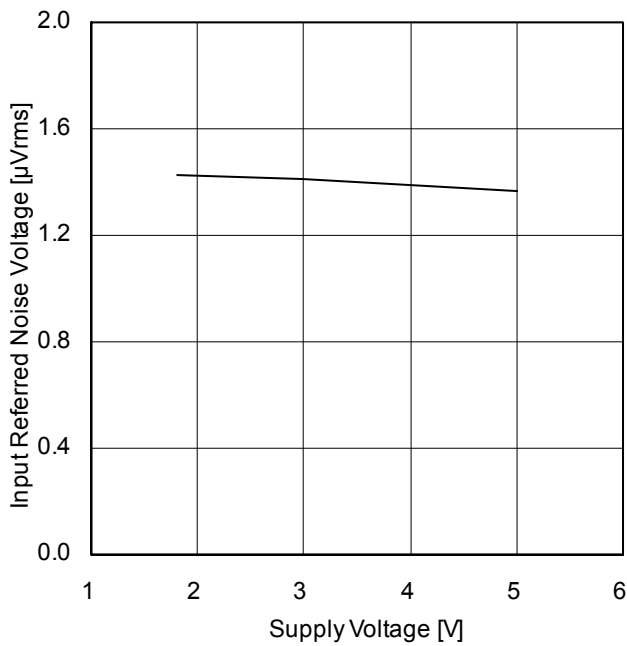

Figure 25.  
Input Referred Noise Voltage vs Supply Voltage  
( $T_A=25^\circ\text{C}$ )

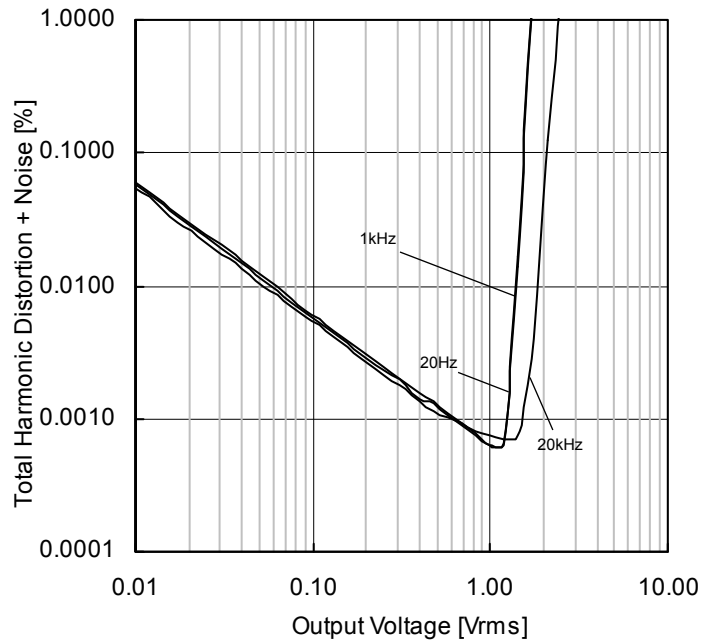

Figure 26.  
Total Harmonic Distortion + Noise vs Output Voltage  
( $V_+=5\text{V}$ ,  $R_L=2\text{k}\Omega$ ,  $T_A=25^\circ\text{C}$ )

(\*)The data above are measurement values of typical sample, it is not guaranteed.

Typical Performance Curves – Continued

OBD12732xxx

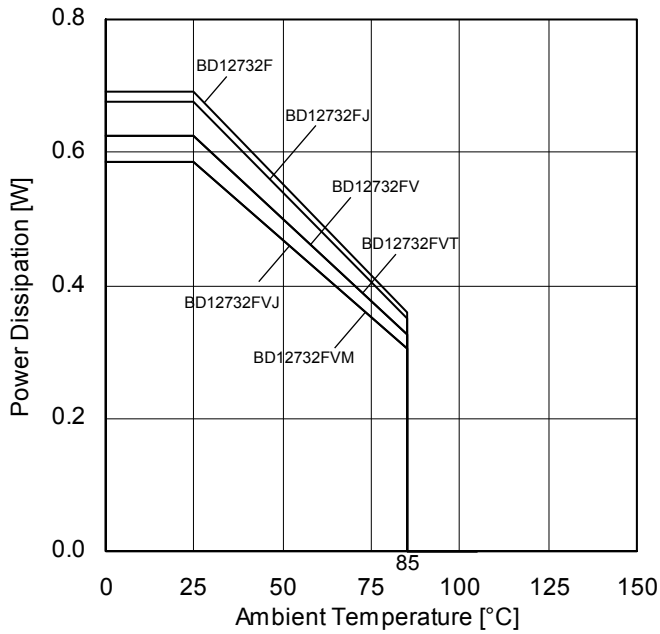

Figure 27.  
Power Dissipation vs Ambient Temperature  
(Derating Curve)

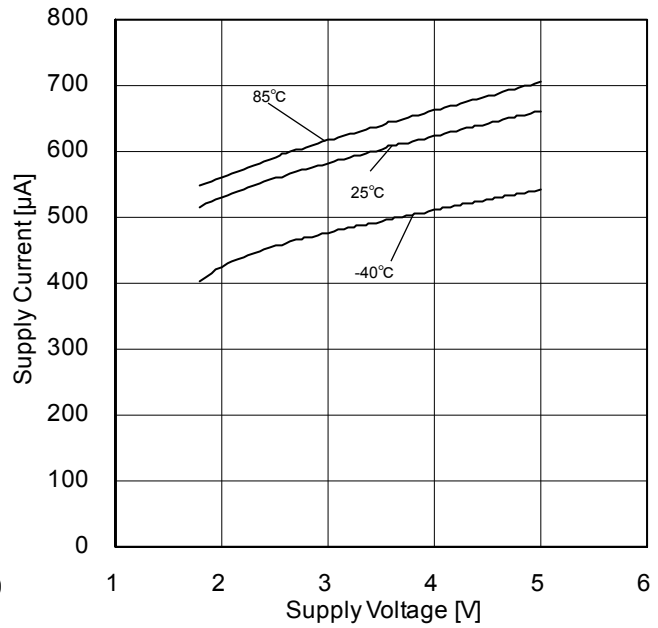

Figure 28.  
Supply Current vs Supply Voltage

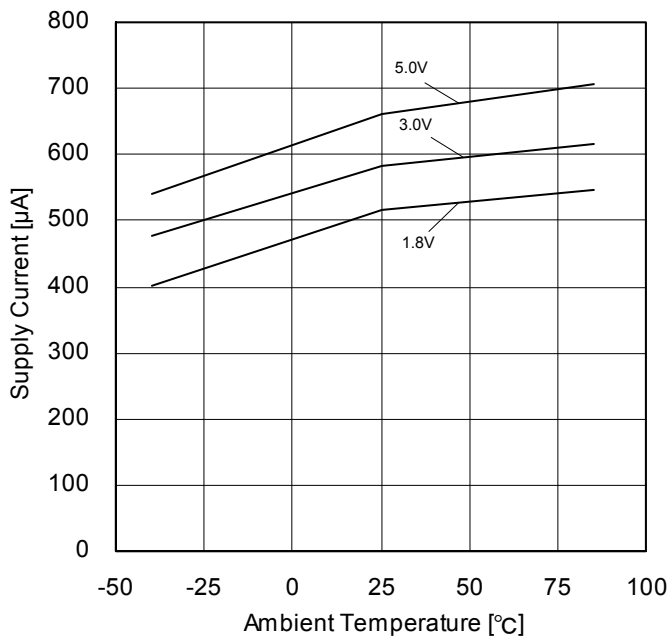

Figure 29.  
Supply Current vs Ambient Temperature

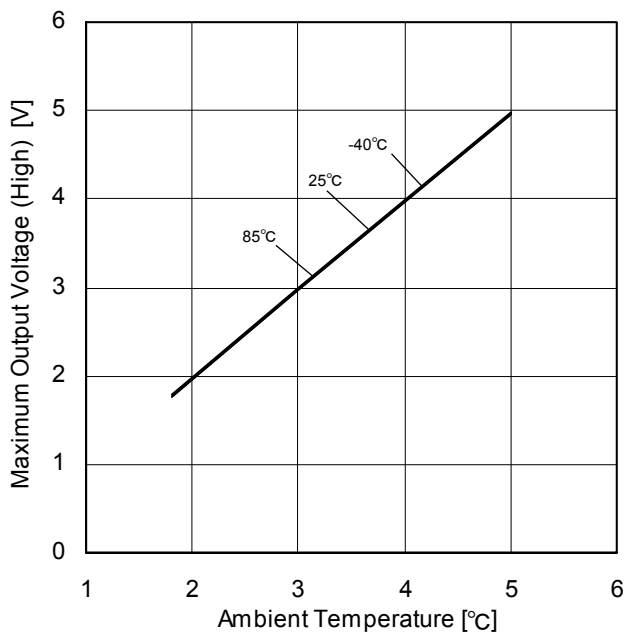

Figure 30.  
Maximum Output Voltage (High) vs Supply Voltage  
( $R_L=20k\Omega$ )

(\*)The data above are measurement values of typical sample, it is not guaranteed.

Typical Performance Curves – Continued

OBD12732xxx

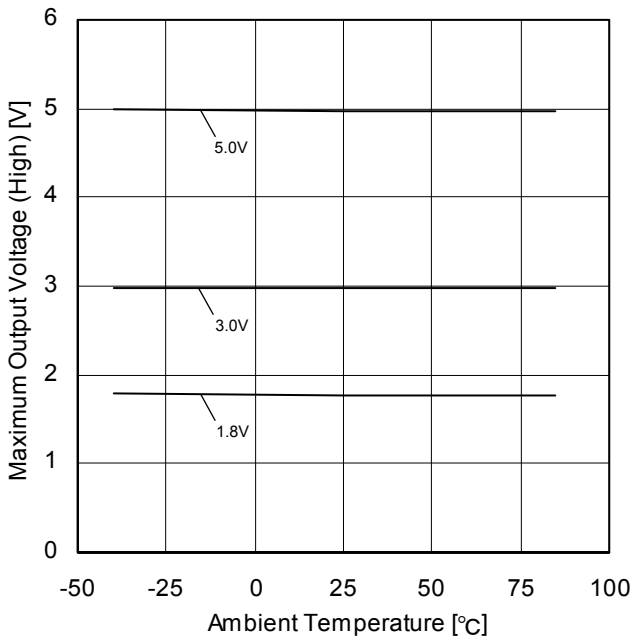

Figure 31.  
Maximum Output Voltage (High) vs Ambient Temperature  
( $R_L=20k\Omega$ )

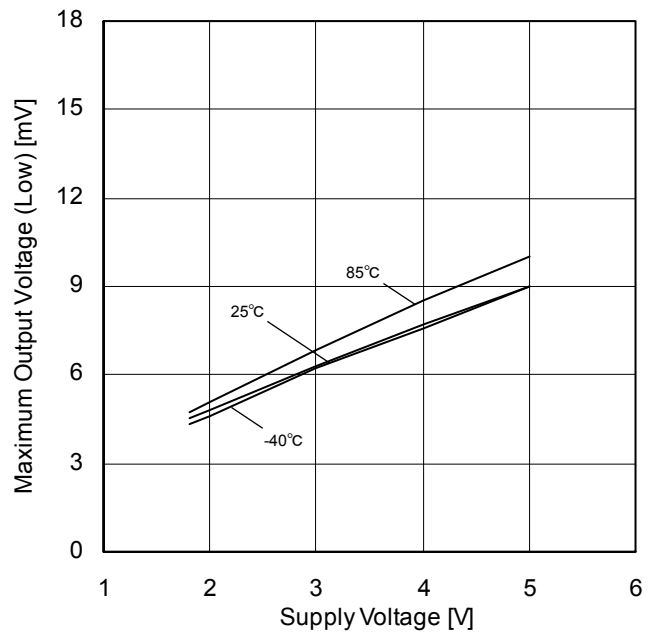

Figure 32.  
Maximum Output Voltage (Low) vs Supply Voltage  
( $R_L=20k\Omega$ )

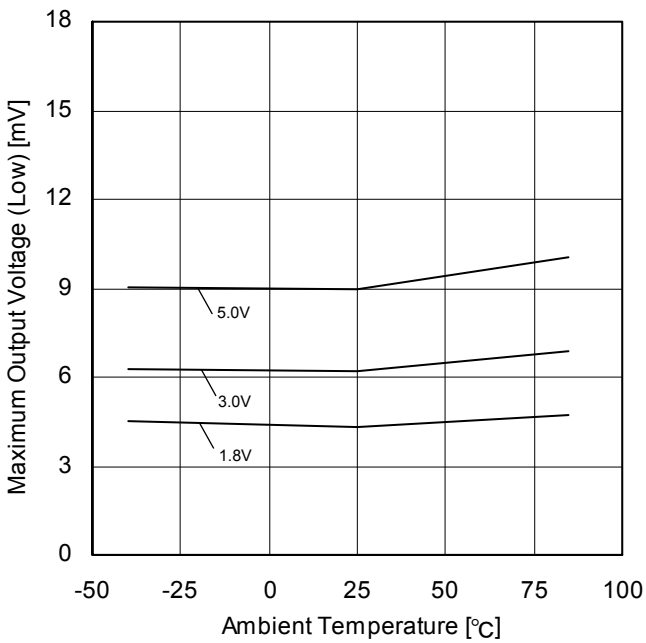

Figure 33.  
Maximum Output Voltage (Low) vs Ambient Temperature  
( $R_L=20k\Omega$ )

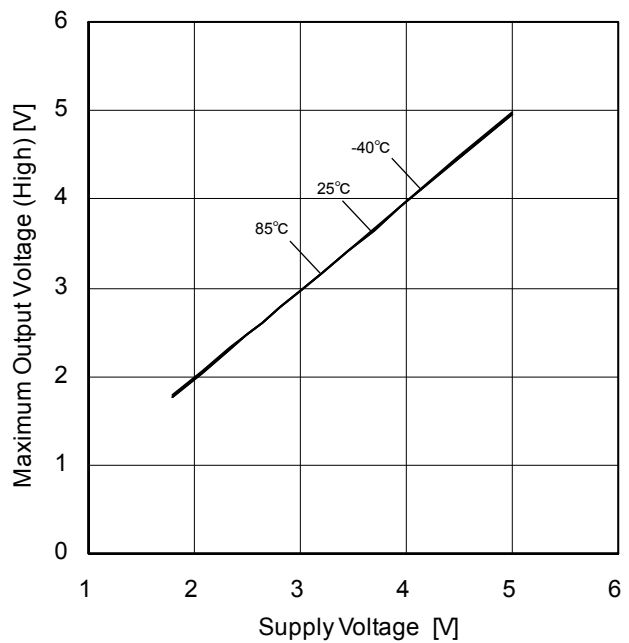

Figure 34.  
Maximum Output Voltage (High) vs Supply Voltage  
( $R_L=2k\Omega$ )

(\*)The data above are measurement values of typical sample, it is not guaranteed.



Typical Performance Curves – Continued

OBD12732xxx

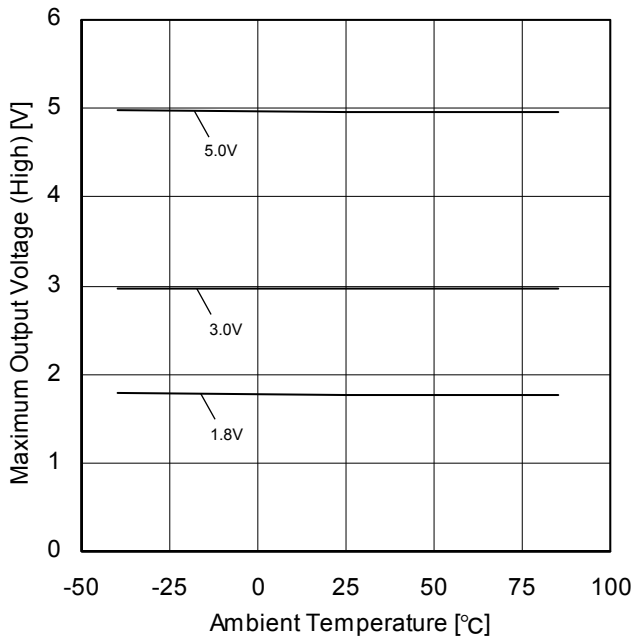

Figure 35.  
Maximum Output Voltage (High) vs Ambient Temperature  
( $R_L=2k\Omega$ )

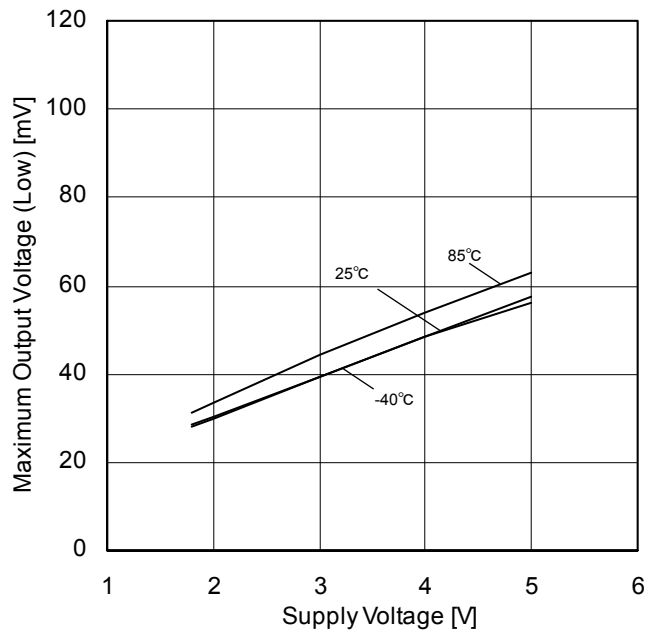

Figure 36.  
Maximum Output Voltage (Low) vs Supply Voltage  
( $R_L=2k\Omega$ )

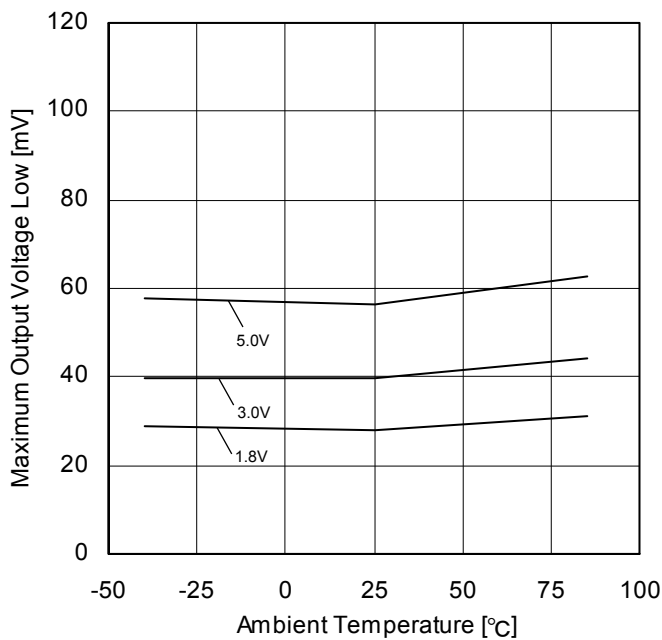

Figure 37.  
Maximum Output Voltage (Low) vs Ambient Temperature  
( $R_L=2k\Omega$ )

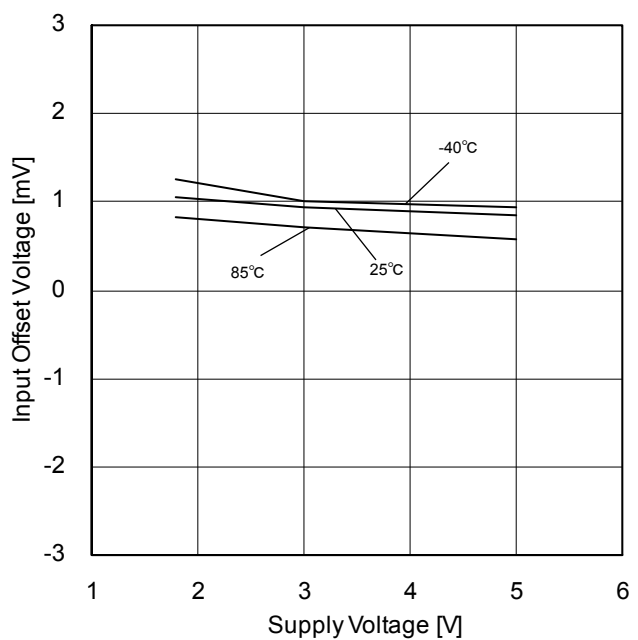

Figure 38.  
Input Offset Voltage vs Supply Voltage

(\*)The data above are measurement values of typical sample, it is not guaranteed.

Typical Performance Curves – Continued

OBD12732xxx

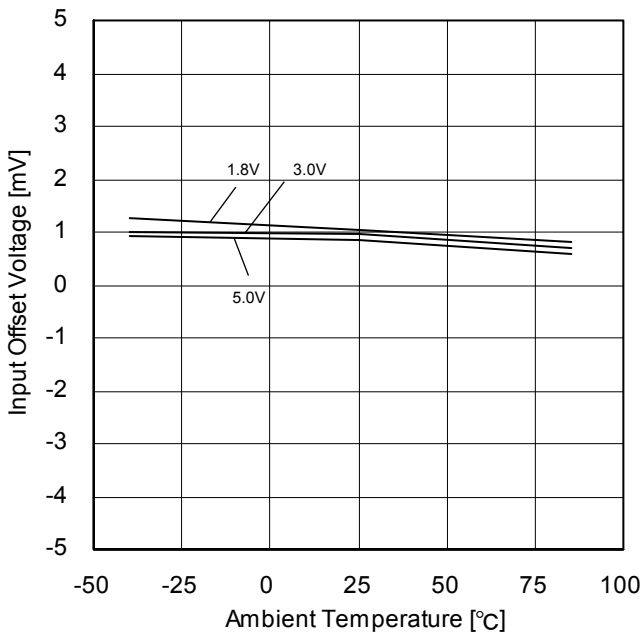

Figure 39.  
Input Offset Voltage vs Ambient Temperature

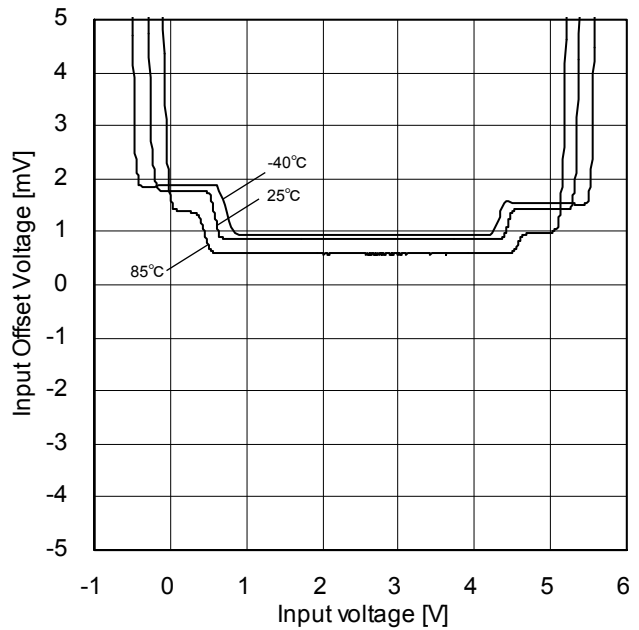

Figure 40.  
Input Common Mode Voltage Range  
(V+=5V)

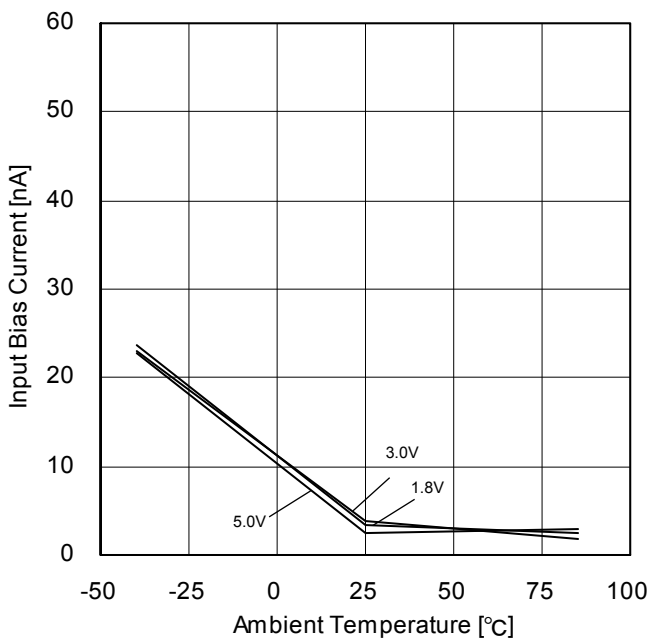

Figure 41.  
Input Bias Current vs Ambient Temperature

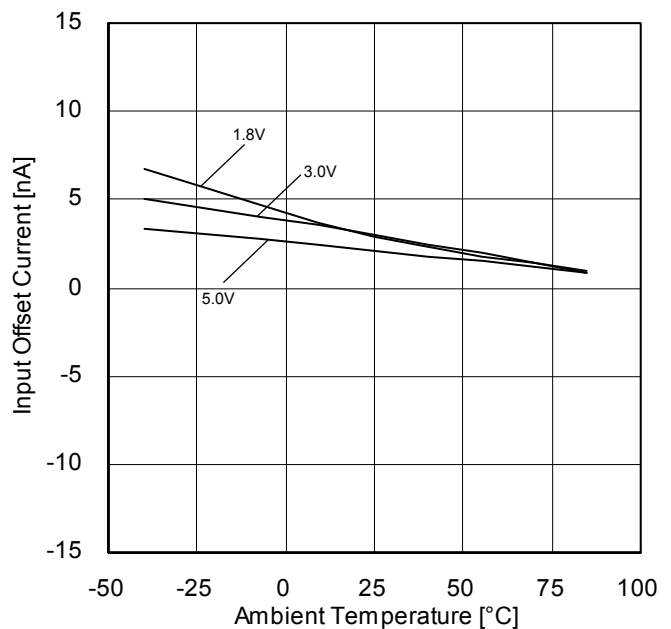

Figure 42.  
Input Offset Current vs Ambient Temperature

(\*)The data above are measurement values of typical sample, it is not guaranteed.

Typical Performance Curves – Continued

OBD12732xxx

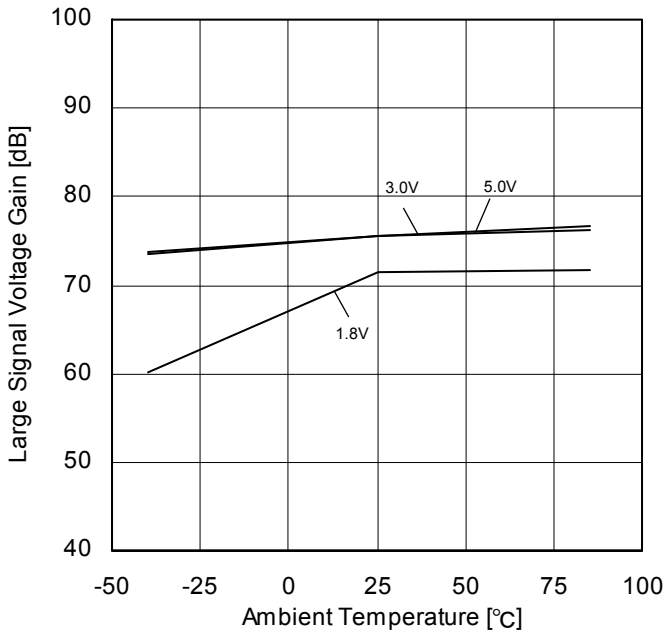

Figure 43.  
Large Signal Voltage Gain vs Ambient Temperature  
( $R_L=2k\Omega$ )

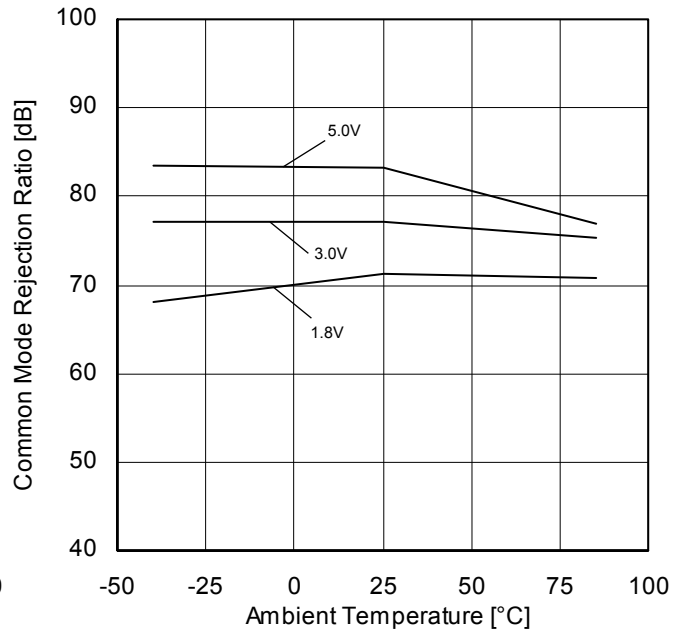

Figure 44.  
Common Mode Rejection Ratio vs Ambient Temperature

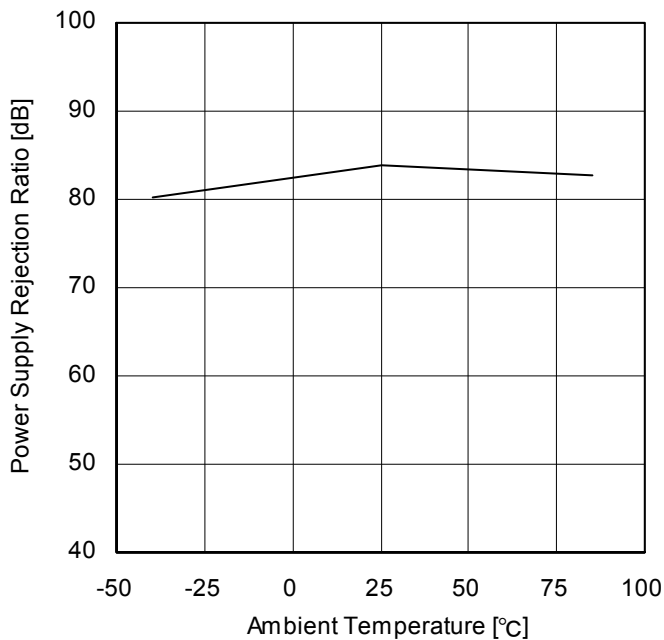

Figure 45.  
Power Supply Rejection Ratio vs Ambient Temperature  
( $V+=1.8V$  to  $5.0V$ )

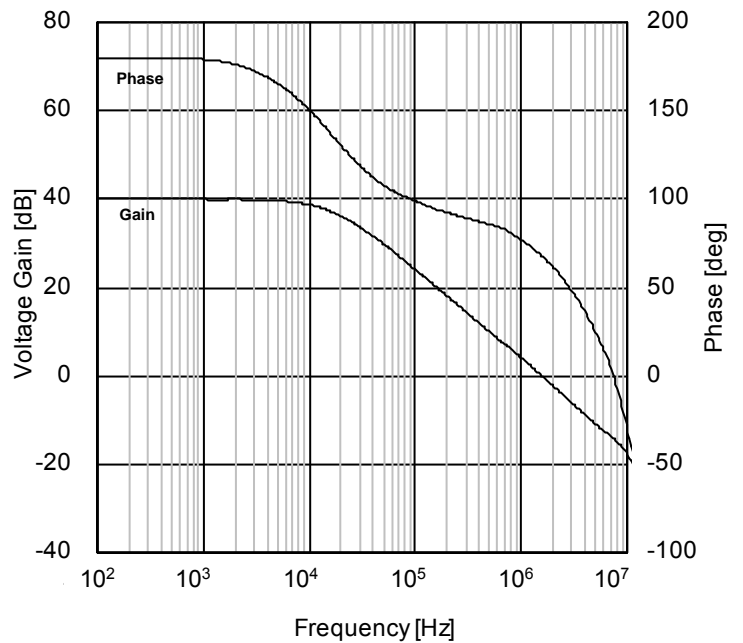

Figure 46.  
Voltage Gain · Phase vs Frequency  
( $V+=5V$ ,  $R_L=2k\Omega$ ,  $T_A=25^\circ C$ )

(\*)The data above are measurement values of typical sample, it is not guaranteed.

Typical Performance Curves – Continued

OBD12732xxx

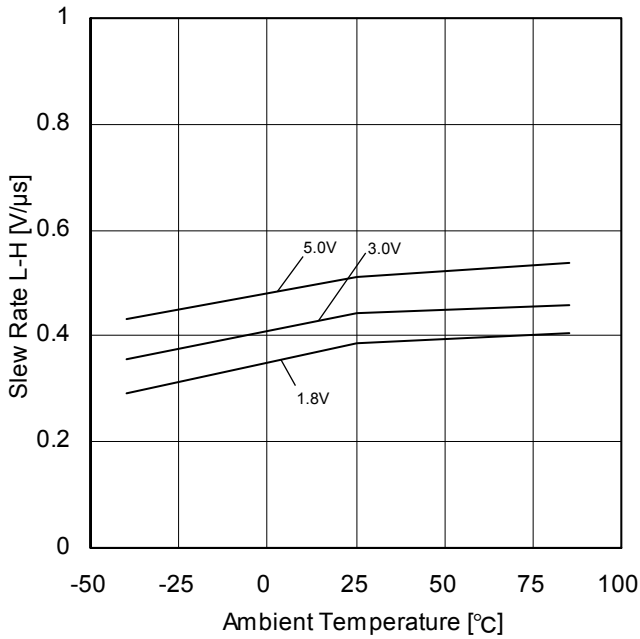

Figure 47.  
Slew Rate L-H vs Ambient Temperature  
( $R_L=2k\Omega$ )

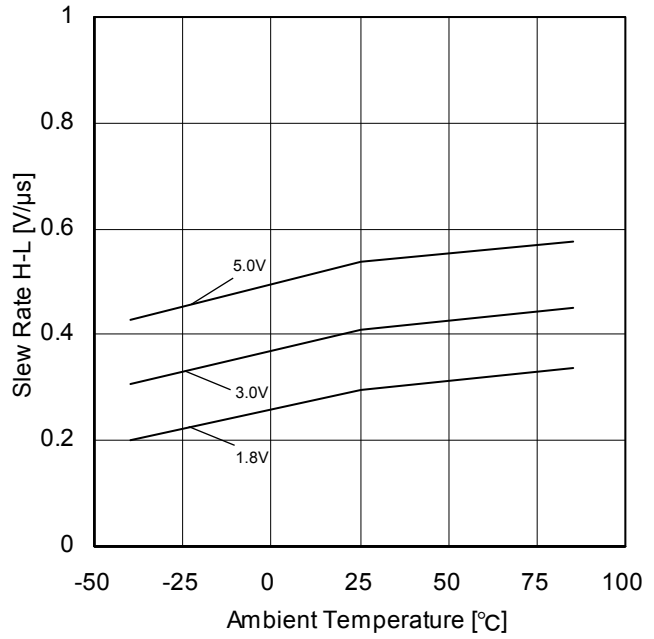

Figure 48.  
Slew Rate H-L vs Ambient Temperature  
( $R_L=2k\Omega$ )

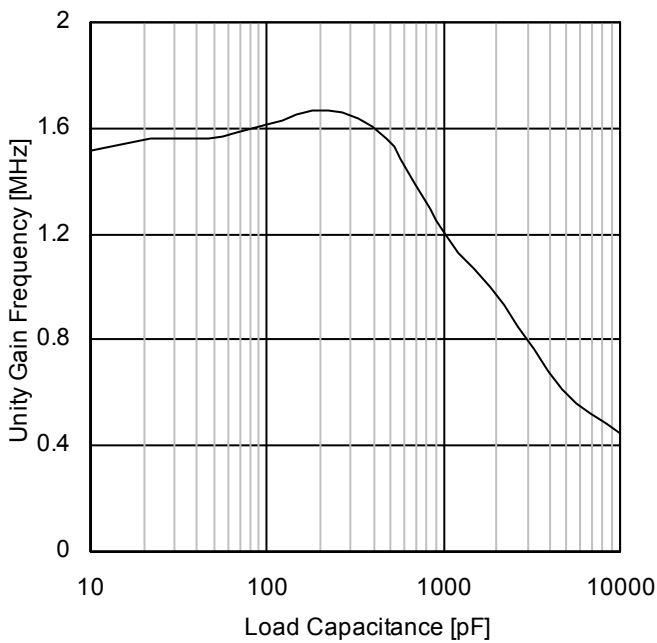

Figure 49.  
Unity Gain Frequency vs Load Capacitance  
( $V_+=5V, T_A=25^\circ C$ )

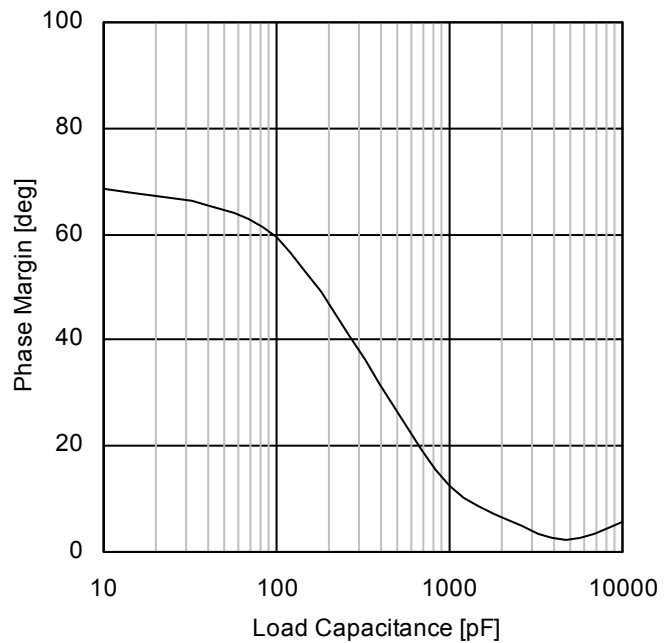

Figure 50.  
Phase Margin vs Load Capacitance  
( $V_+=5V, T_A=25^\circ C$ )

(\*)The data above are measurement values of typical sample, it is not guaranteed.

Typical Performance Curves – Continued

OBD12732xxx

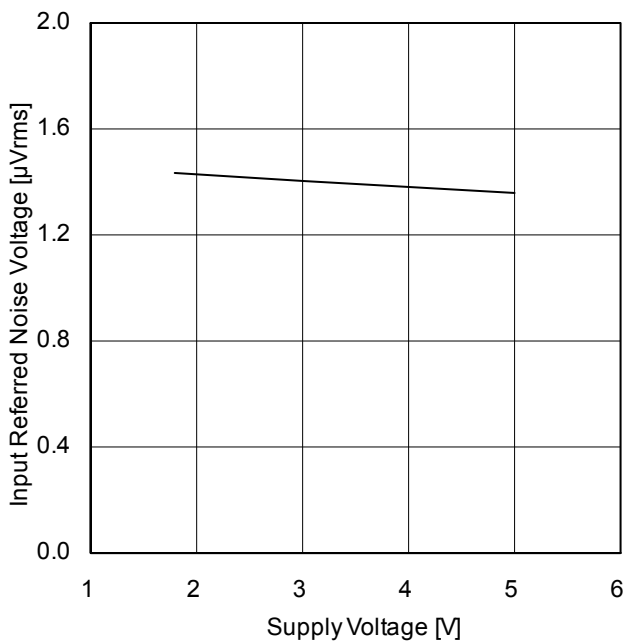

Figure 51.  
Input Referred Noise Voltage vs Supply Voltage  
( $T_A=25^\circ\text{C}$ )

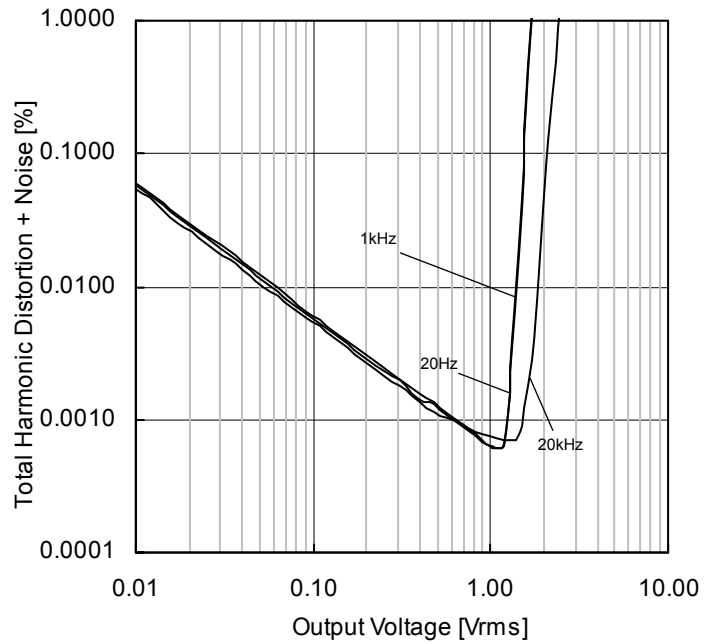

Figure 52.  
Total Harmonic Distortion + Noise vs Output Voltage  
( $V_+=5\text{V}$ ,  $R_L=2\text{k}\Omega$ ,  $T_A=25^\circ\text{C}$ )

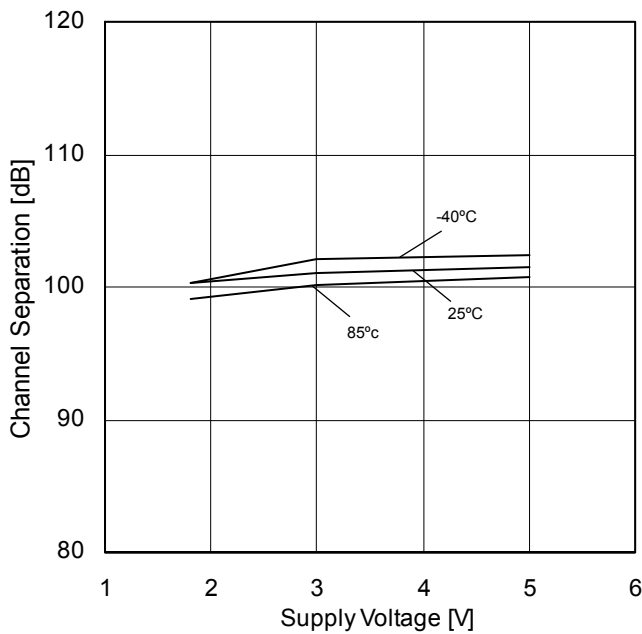

Figure 53.  
Channel Separation vs Supply Voltage

(\*)The data above are measurement values of typical sample, it is not guaranteed.

Typical Performance Curves – Continued

OBD12734xxx

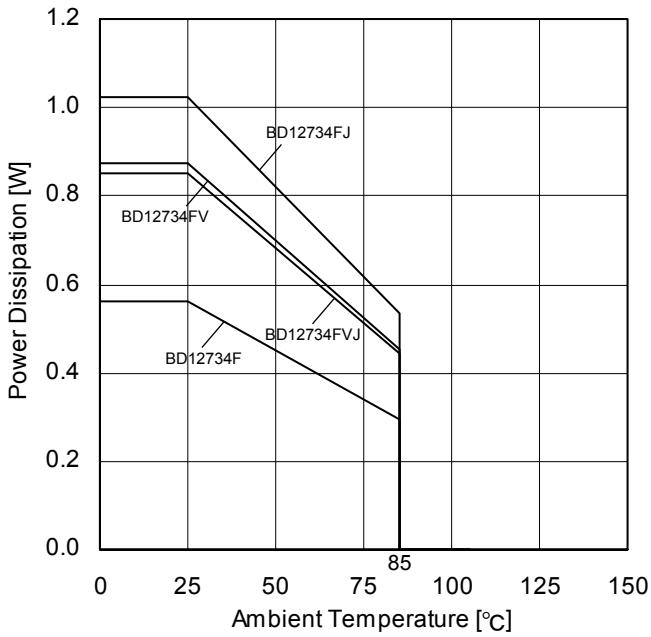

Figure 54.  
Power Dissipation vs Ambient Temperature  
(Derating Curve)

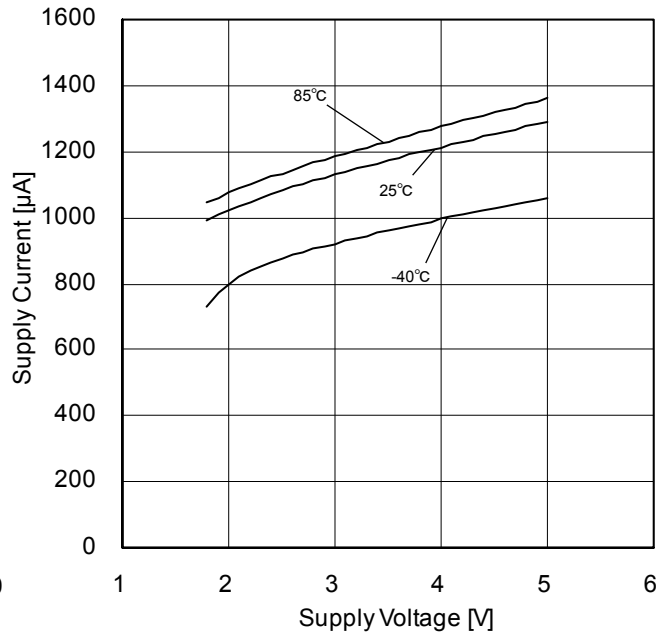

Figure 55.  
Supply Current vs Supply Voltage

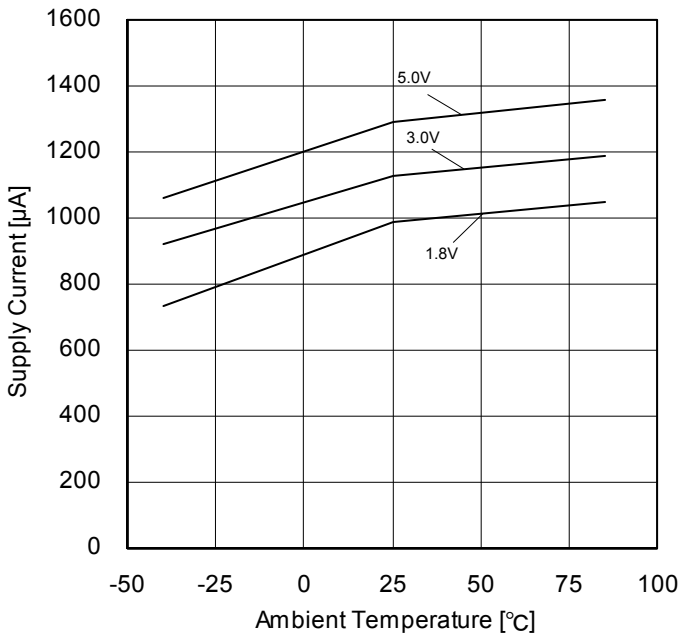

Figure 56.  
Supply Current vs Ambient Temperature

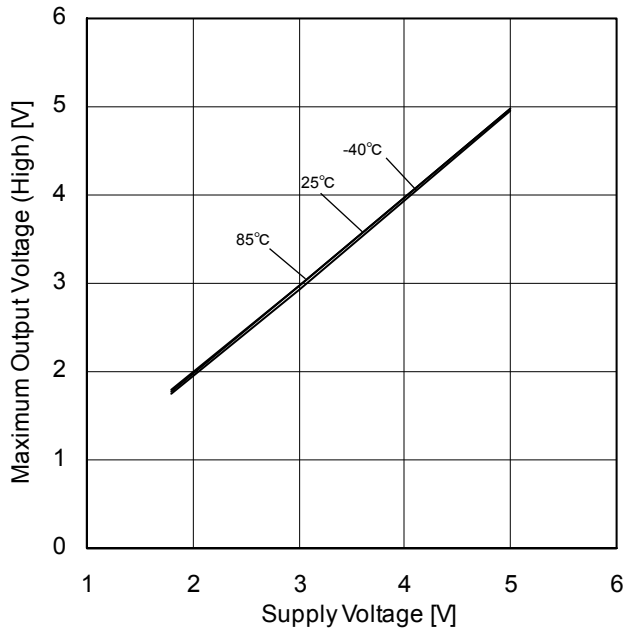

Figure 57.  
Maximum Output Voltage (High) vs Supply Voltage  
( $R_L=20k\Omega$ )

(\*)The data above are measurement values of typical sample, it is not guaranteed.

Typical Performance Curves – Continued

OBD12734xxx

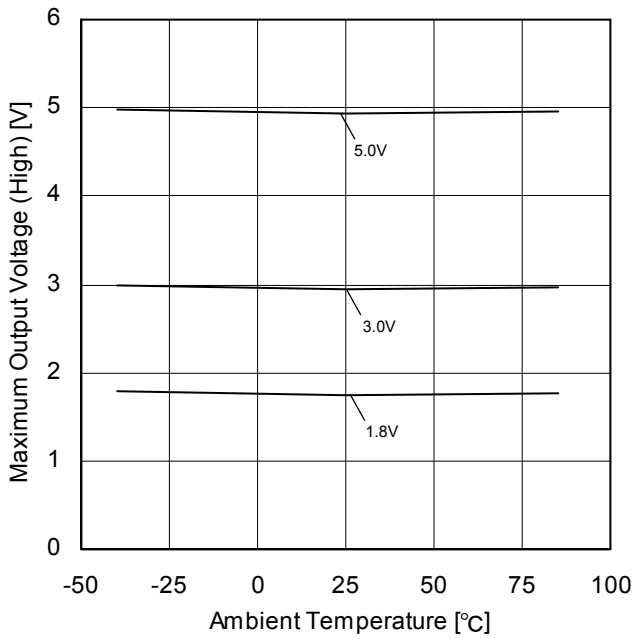

Figure 58.  
Maximum Output Voltage (High) vs Ambient Temperature  
( $R_L=20k\Omega$ )

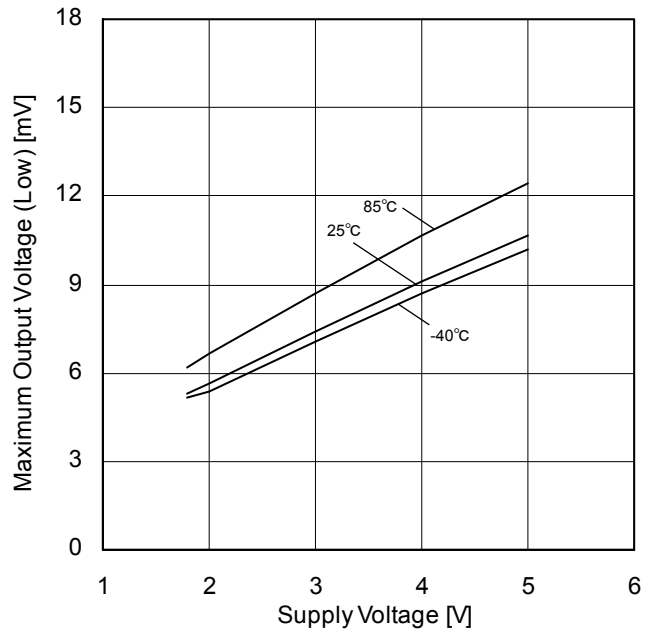

Figure 59.  
Maximum Output Voltage (Low) vs Supply Voltage  
( $R_L=20k\Omega$ )

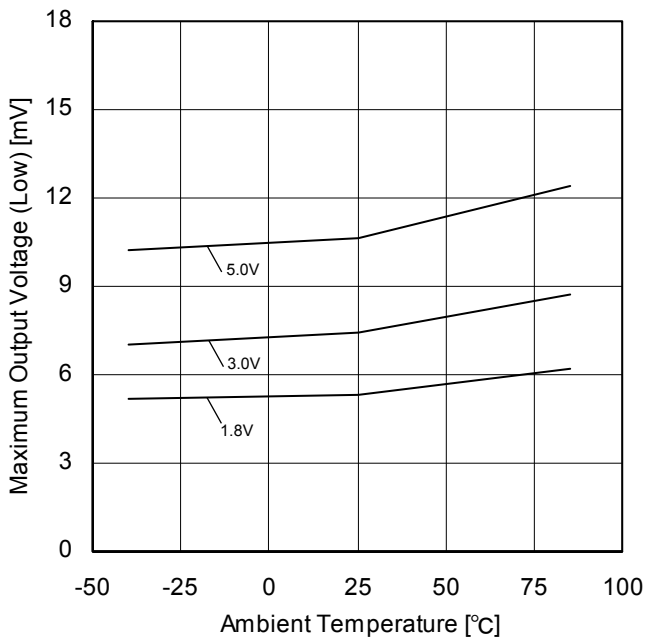

Figure 60.  
Maximum Output Voltage (Low) vs Ambient Temperature  
( $R_L=20k\Omega$ )

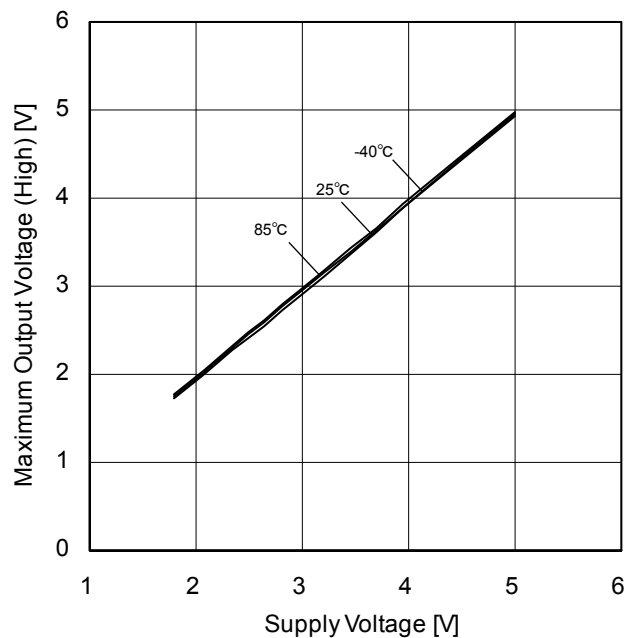

Figure 61.  
Maximum Output Voltage (High) vs Supply Voltage  
( $R_L=2k\Omega$ )

(\*)The data above are measurement values of typical sample, it is not guaranteed.

Typical Performance Curves – Continued

OBD12734xxx

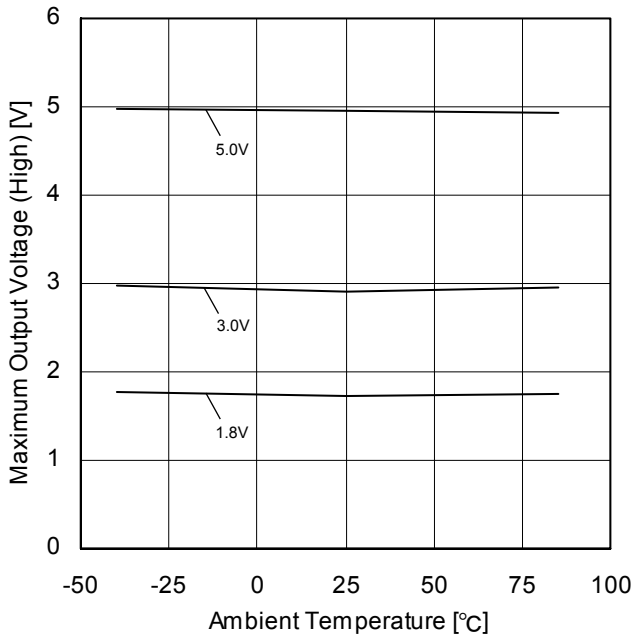

Figure 62.  
Maximum Output Voltage (High) vs Ambient Temperature  
( $R_L=2k\Omega$ )

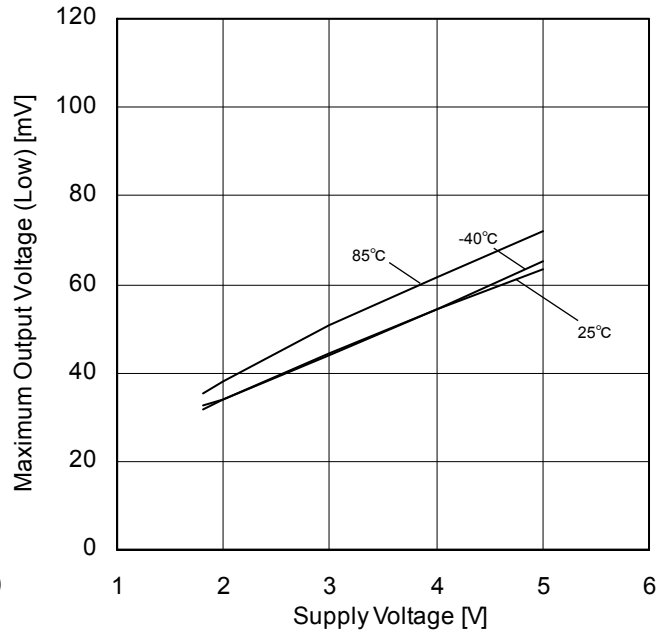

Figure 63.  
Maximum Output Voltage (Low) vs Supply Voltage  
( $R_L=2k\Omega$ )

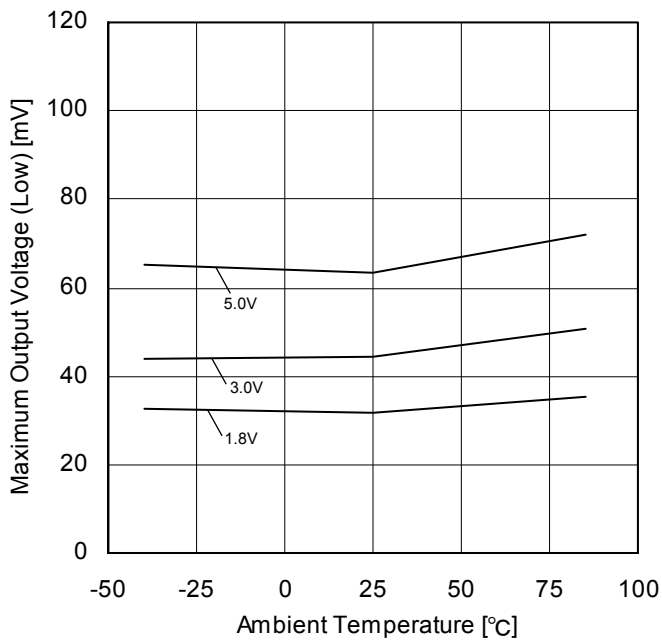

Figure 64.  
Maximum Output Voltage (Low) vs Ambient Temperature  
( $R_L=2k\Omega$ )

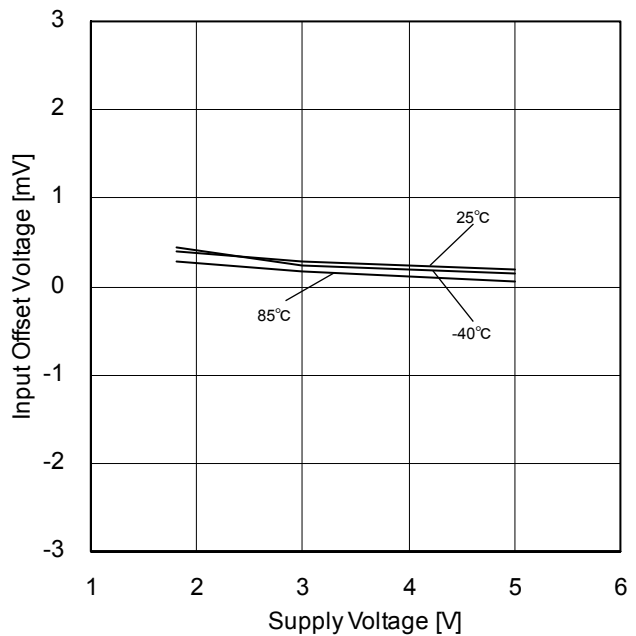

Figure 65.  
Input Offset Voltage vs Supply Voltage

(\*)The data above are measurement values of typical sample, it is not guaranteed.



Typical Performance Curves – Continued

OBD12734xxx

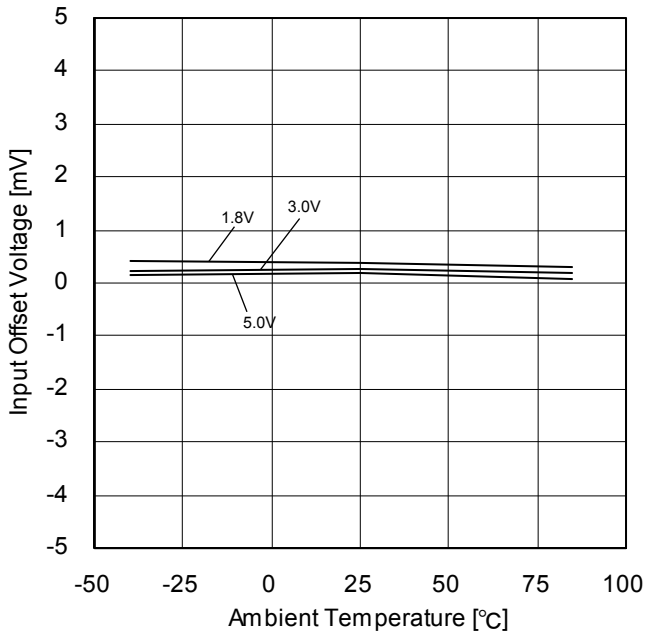

Figure 66.  
Input Offset Voltage vs Ambient Temperature

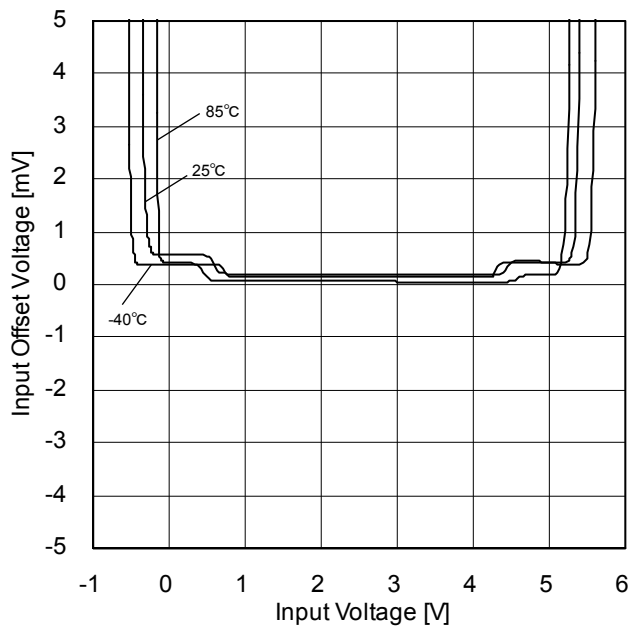

Figure 67.  
Input Common Mode Voltage Range  
(V+=5V)

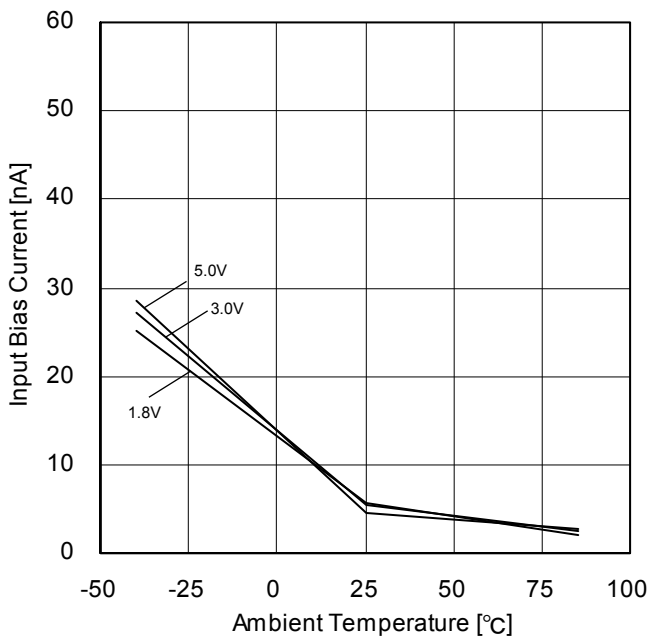

Figure 68.  
Input Bias Current vs Ambient Temperature

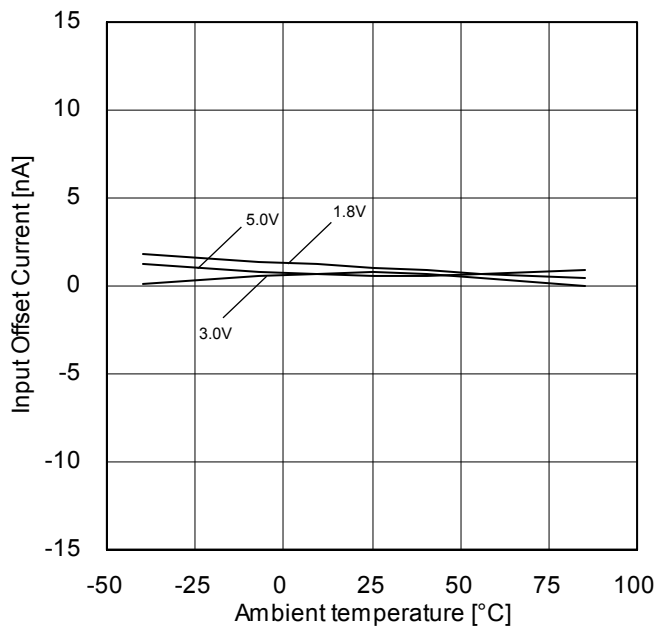

Figure 69.  
Input Offset Current vs Ambient Temperature

(\*)The data above are measurement values of typical sample, it is not guaranteed.

Typical Performance Curves – Continued

OBD12734xxx

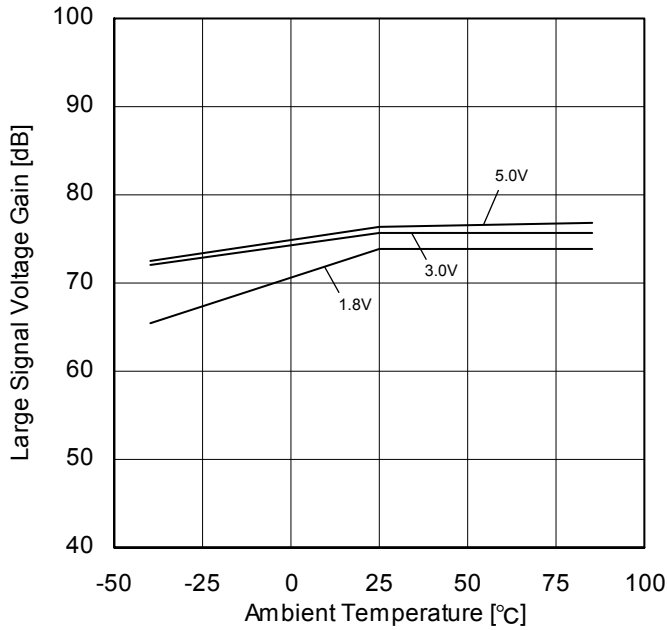

Figure 70.  
Large Signal Voltage Gain vs Ambient Temperature  
( $R_L=2k\Omega$ )

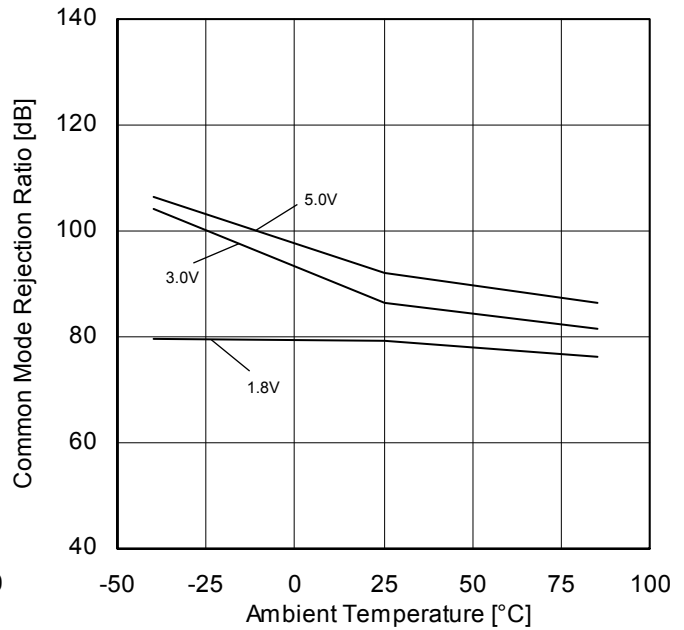

Figure 71.  
Common Mode Rejection Ratio vs Ambient Temperature

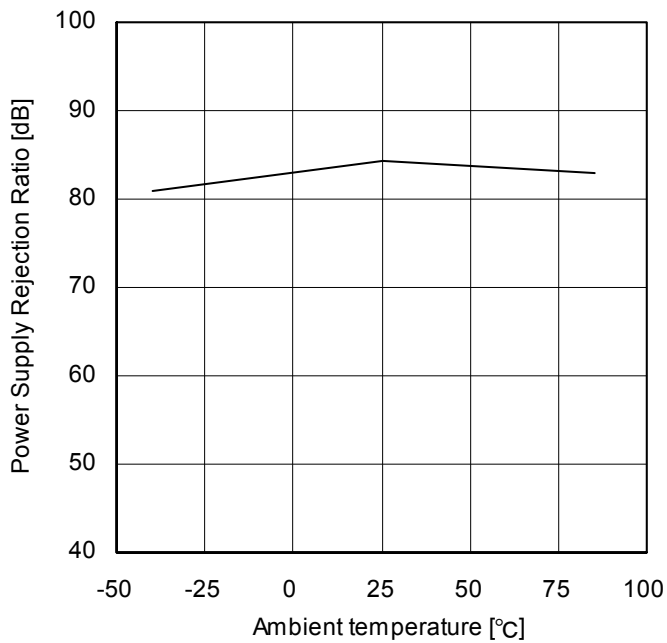

Figure 72.  
Power Supply Rejection Ratio vs Ambient Temperature  
( $V_+=1.8V$  to  $5.0V$ )

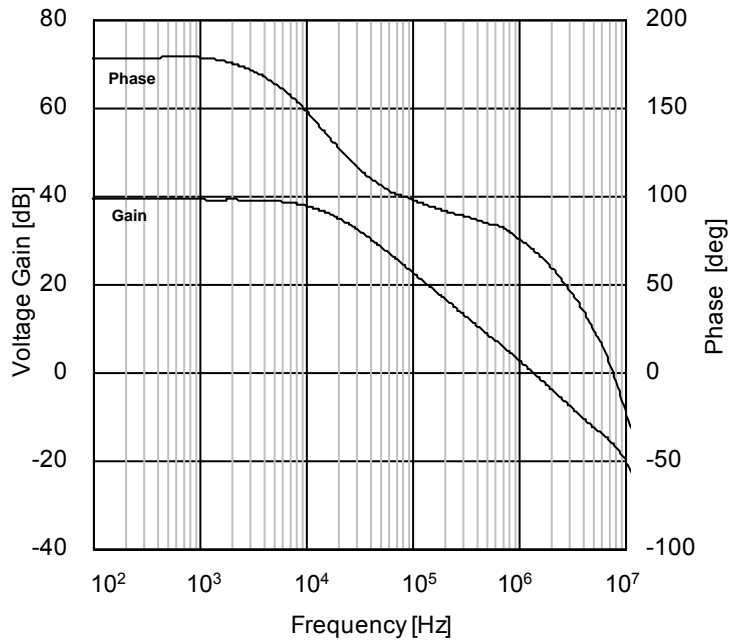

Figure 73.  
Voltage Gain · Phase vs Frequency  
( $V_+=5V$ ,  $R_L=2k\Omega$ ,  $T_A=25^\circ C$ )

(\*)The data above are measurement values of typical sample, it is not guaranteed.

Typical Performance Curves – Continued

OBD12734xxx

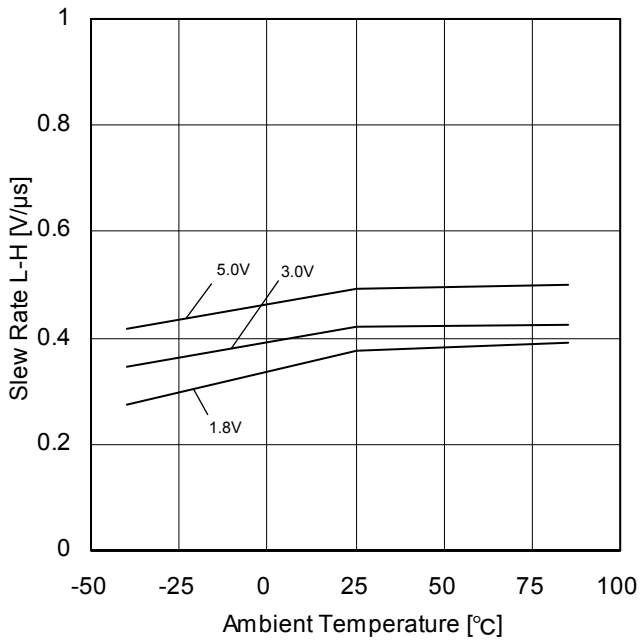

Figure 74.  
Slew Rate L-H vs Ambient Temperature  
( $R_L=2k\Omega$ )

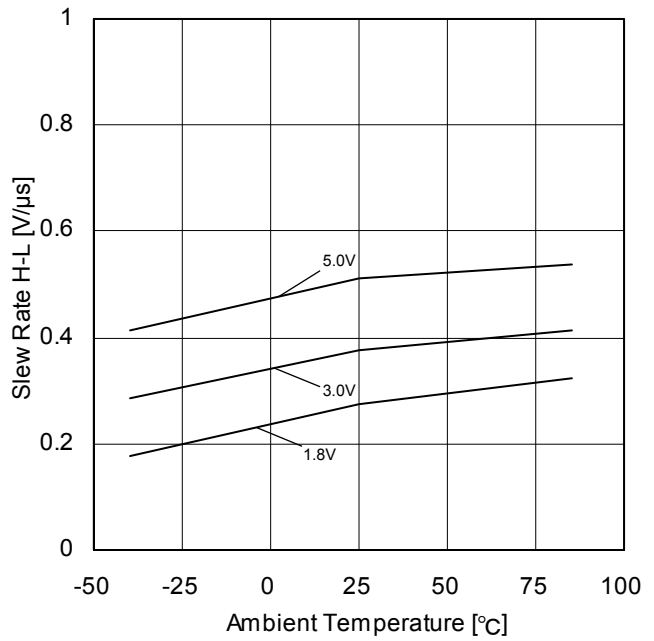

Figure 75.  
Slew Rate H-L vs Ambient Temperature  
( $R_L=2k\Omega$ )

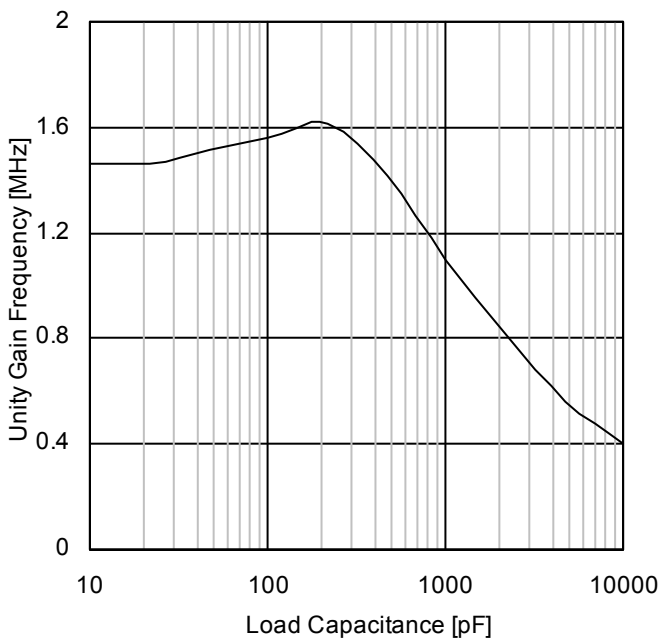

Figure 76.  
Unity Gain Frequency vs Load Capacitance  
( $V_+=5V, T_A=25^\circ C$ )

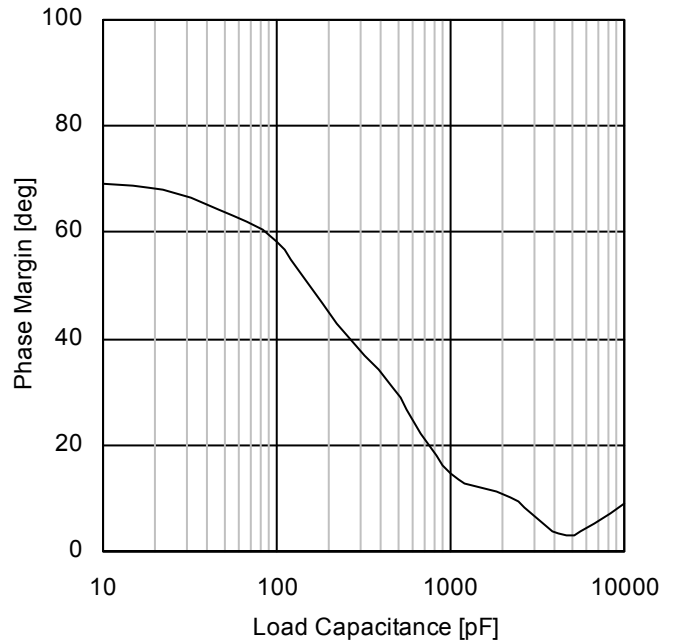

Figure 77.  
Phase Margin vs Load Capacitance  
( $V_+=5V, T_A=25^\circ C$ )

(\*)The data above are measurement values of typical sample, it is not guaranteed.

Typical Performance Curves – Continued

OBD12734xxx

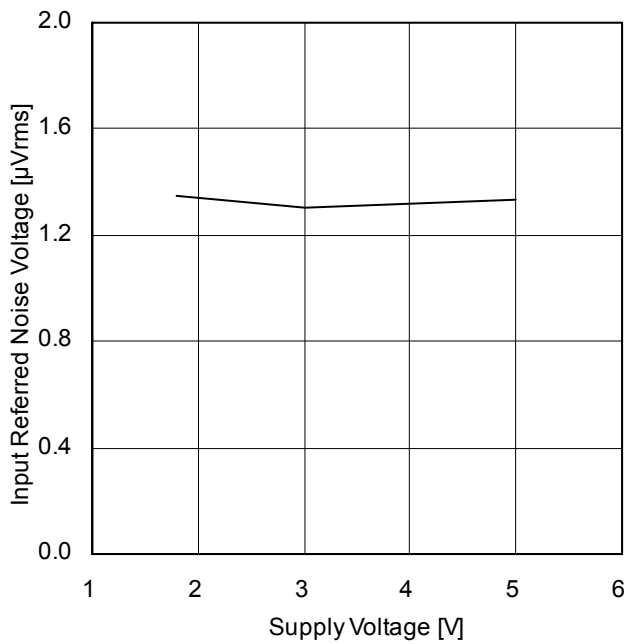

Figure 78.  
Input Referred Noise Voltage vs Supply Voltage  
( $T_A=25^\circ\text{C}$ )

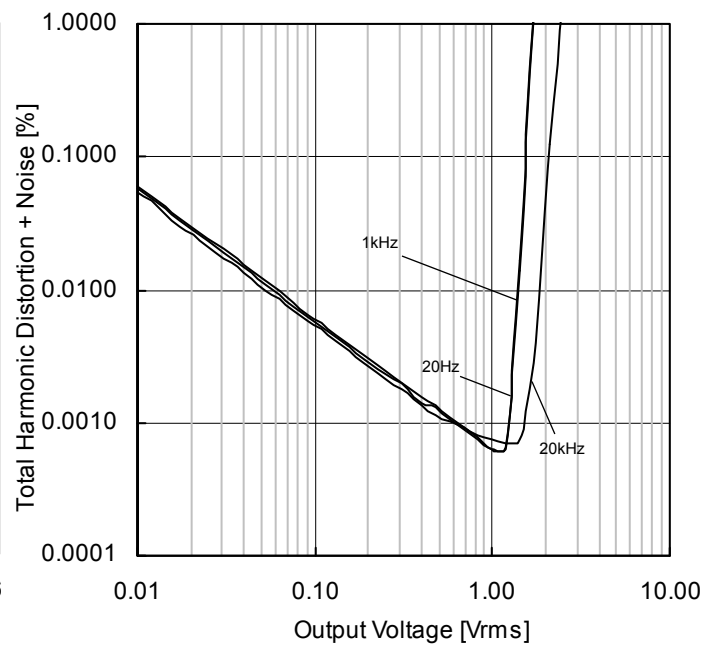

Figure 79.  
Total Harmonic Distortion + Noise vs Output Voltage  
( $V_+=5\text{V}$ ,  $R_L=2\text{k}\Omega$ ,  $T_A=25^\circ\text{C}$ )

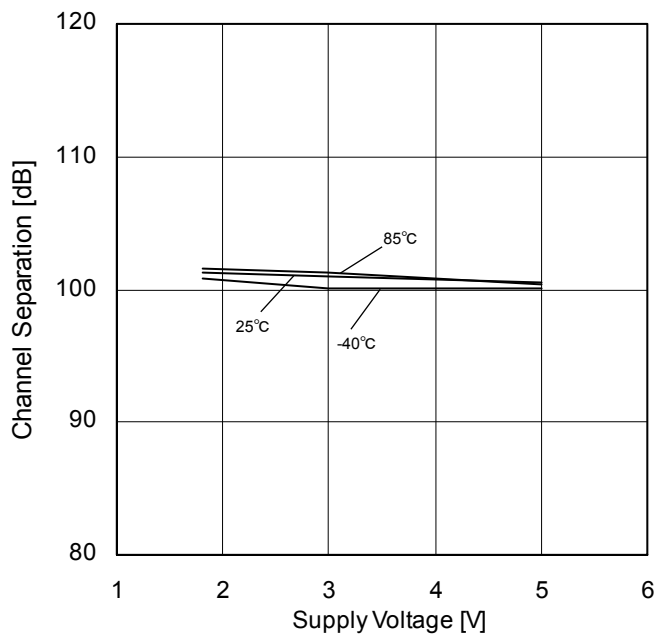

Figure 80.  
Channel Separation vs Supply Voltage

(\*)The data above are measurement values of typical sample, it is not guaranteed.

**Application Information**  
**NULL method condition for Test Circuit 1**

V+, GND, V<sub>RL</sub>, E<sub>K</sub>, V<sub>ICM</sub> Unit: V

Parameter	V <sub>F</sub>	S1	S2	S3	V+	GND	V <sub>RL</sub>	R <sub>L</sub> Ω	E <sub>K</sub>	V <sub>ICM</sub>	Calculation
Input Offset Voltage	V <sub>F1</sub>	ON	ON	OFF	5.0	0	-	open	-2.5	2.5	1
Large Signal Voltage Gain	V <sub>F2</sub>	ON	ON	ON	5.0	0	2.5	2k	-4.5	2.5	2
	V <sub>F3</sub>								-0.5		
Common Mode Rejection Ratio (Input Common-mode Voltage Range)	V <sub>F4</sub>	ON	ON	OFF	5.0	0	-	open	-2.5	0	3
	V <sub>F5</sub>								-2.5	5.0	
Power Supply Rejection Ratio	V <sub>F6</sub>	ON	ON	OFF	5.0	0	-	open	-0.9	0.9	4
	V <sub>F7</sub>				1.8						

— Calculation —

1. Input Offset Voltage (V<sub>IO</sub>) 
$$V_{IO} = \frac{|V_{F1}|}{1+R_F/R_S} \text{ [V]}$$
2. Large Signal Voltage Gain (A<sub>v</sub>) 
$$A_v = 20\text{Log} \frac{\Delta E_K \times (1+R_F/R_S)}{|V_{F2}-V_{F3}|} \text{ [dB]}$$
3. Common-mode Rejection Ratio (CMRR) 
$$\text{CMRR} = 20\text{Log} \frac{\Delta V_{ICM} \times (1+R_F/R_S)}{|V_{F4} - V_{F5}|} \text{ [dB]}$$
4. Power Supply Rejection Ratio (PSRR) 
$$\text{PSRR} = 20\text{Log} \frac{\Delta V+ \times (1+R_F/R_S)}{|V_{F6} - V_{F7}|} \text{ [dB]}$$

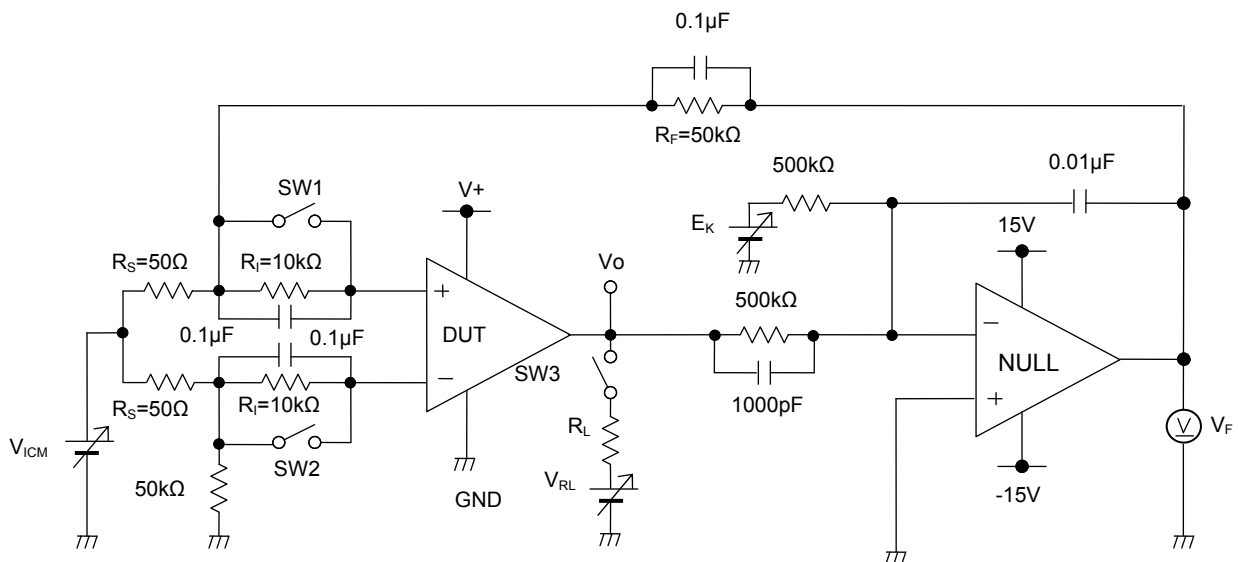

Figure 81. Test Circuit 1

Application Information – continued  
Switch Condition for Test Circuit 2

SW No.	SW1	SW2	SW3	SW4	SW5	SW6	SW7	SW8	SW9	SW10	SW11	SW12
Supply Current	OFF	OFF	ON	OFF	ON	OFF	OFF	OFF	OFF	OFF	OFF	OFF
Maximum Output Voltage $R_L=10k\Omega$	OFF	ON	OFF	OFF	ON	OFF	OFF	ON	OFF	OFF	ON	OFF
Output Current	OFF	ON	OFF	OFF	ON	OFF	OFF	OFF	OFF	ON	OFF	OFF
Slew Rate	OFF	OFF	ON	OFF	OFF	OFF	ON	ON	OFF	OFF	OFF	ON
Unity Gain Frequency	ON	OFF	OFF	ON	ON	OFF	OFF	ON	OFF	OFF	OFF	ON

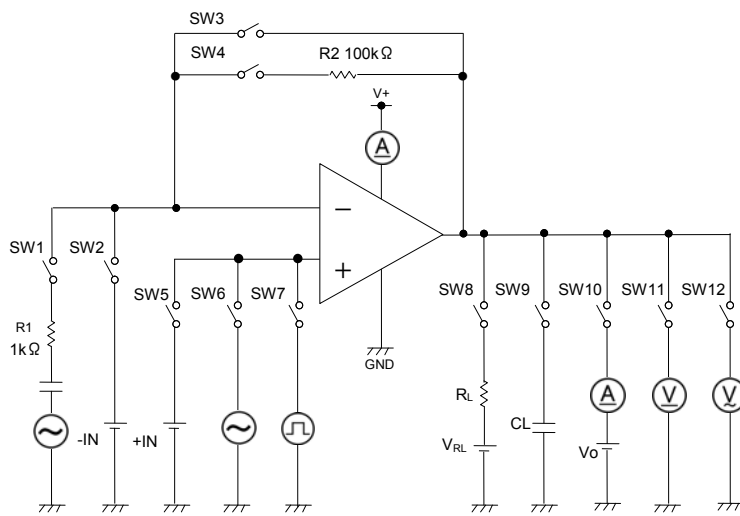

Figure 82. Test Circuit 2

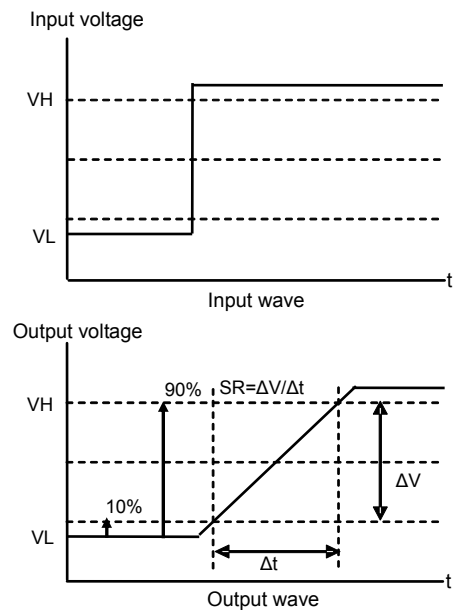

Figure 83. Slew Rate Input Output Wave

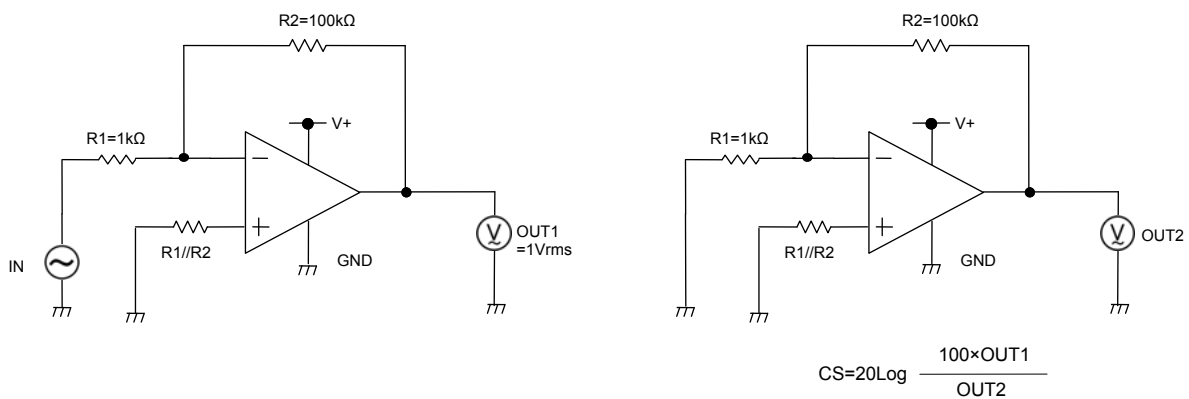

Figure 84. Test Circuit 3 (Channel separation)

**Application Example**

○Voltage follower

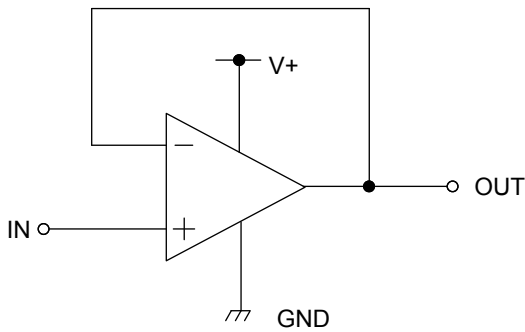

Figure 85. Voltage Follower

Voltage gain is 0dB.

Using this circuit, the output voltage (OUT) is configured to be equal to the input voltage (IN). This circuit also stabilizes the output voltage (OUT) due to high input impedance and low output impedance. Computation for output voltage (OUT) is shown below.

$$OUT=IN$$

○Inverting amplifier

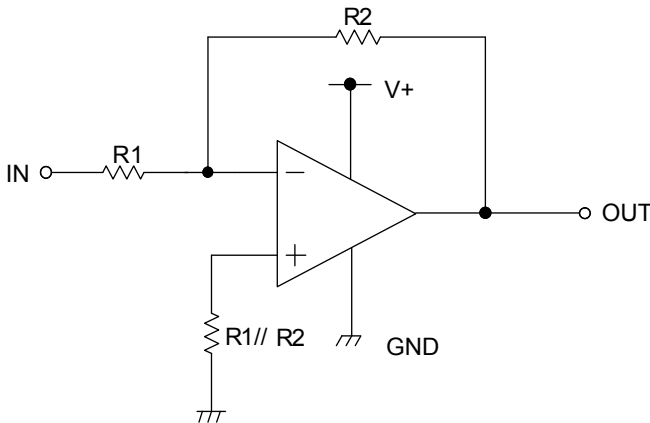

Figure 86. Inverting Amplifier Circuit

For inverting amplifier, input voltage (IN) is amplified by a voltage gain and depends on the ratio of R1 and R2. The out-of-phase output voltage is shown in the next expression

$$OUT=-(R2/R1) \cdot IN$$

This circuit has input impedance equal to R1.

○Non-inverting amplifier

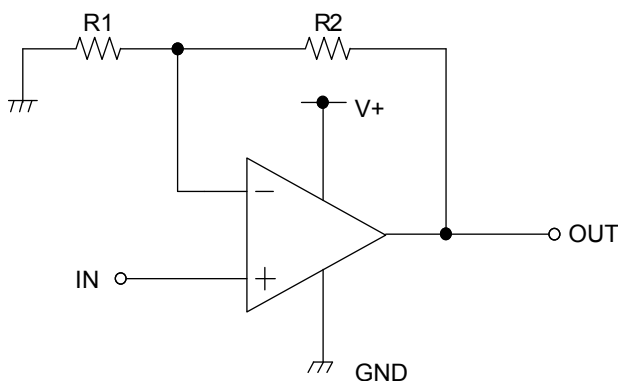

Figure 87. Non-inverting Amplifier Circuit

For non-inverting amplifier, input voltage (IN) is amplified by a voltage gain, which depends on the ratio of R1 and R2. The output voltage (OUT) is -INphase with the input voltage (IN) and is shown in the next expression.

$$OUT=(1 + R2/R1) \cdot IN$$

Effectively, this circuit has high input impedance since its input side is the same as that of the operational amplifier.

**Power Dissipation**

Power dissipation (total loss) indicates the power that the IC can consume at  $T_A=25^\circ\text{C}$  (normal temperature). As the IC consumes power, it heats up, causing its temperature to be higher than the ambient temperature. The allowable temperature that the IC can accept is limited. This depends on the circuit configuration, manufacturing process, and consumable power.

Power dissipation is determined by the allowable temperature within the IC (maximum junction temperature) and the thermal resistance of the package used (heat dissipation capability). Maximum junction temperature is typically equal to the maximum storage temperature. The heat generated through the consumption of power by the IC radiates from the mold resin or lead frame of the package. Thermal resistance, represented by the symbol  $\theta_{JA}^\circ\text{C/W}$ , indicates this heat dissipation capability. Similarly, the temperature of an IC inside its package can be estimated by thermal resistance.

Figure 88(a) shows the model of the thermal resistance of a package. The equation below shows how to compute for the Thermal resistance ( $\theta_{JA}$ ), given the ambient temperature ( $T_A$ ), maximum junction temperature ( $T_{Jmax}$ ), and power dissipation ( $P_D$ ).

$$\theta_{JA} = (T_{Jmax} - T_A) / P_D \quad ^\circ\text{C/W}$$

The Derating curve in Figure 88(b) indicates the power that the IC can consume with reference to ambient temperature. Power consumption of the IC begins to attenuate at certain temperatures. This gradient is determined by Thermal resistance ( $\theta_{JA}$ ), which depends on the chip size, power consumption, package, ambient temperature, package condition, wind velocity, etc. This may also vary even when the same of package is used. Thermal reduction curve indicates a reference value measured at a specified condition. Figure 88(c) to (d) shows an example of the derating curve for BD12730G, BD12732xxx and BD12734xxx.

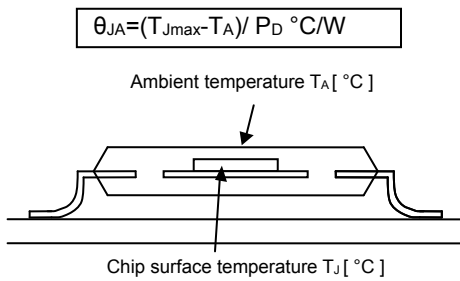

(a) Thermal Resistance

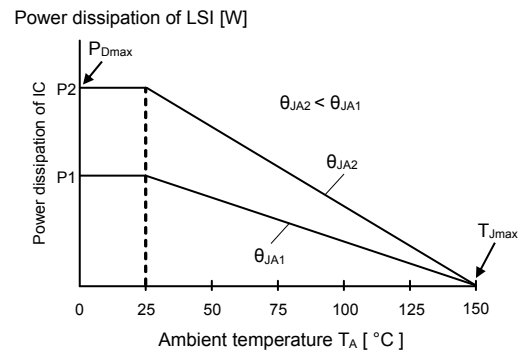

(b) Derating Curve

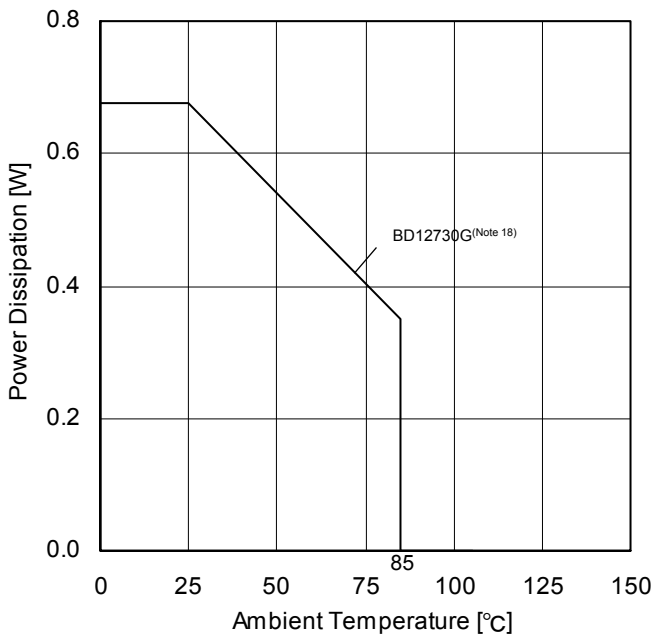

(c) BD12730G

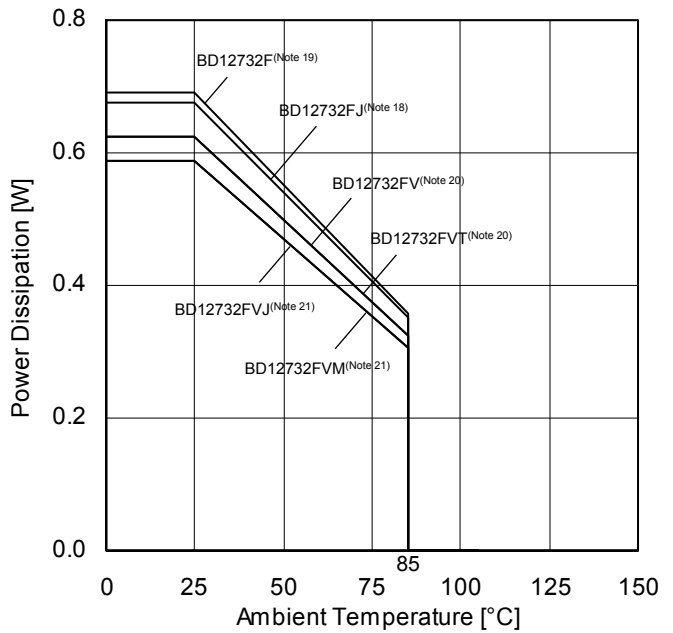

(d) BD12732xxx



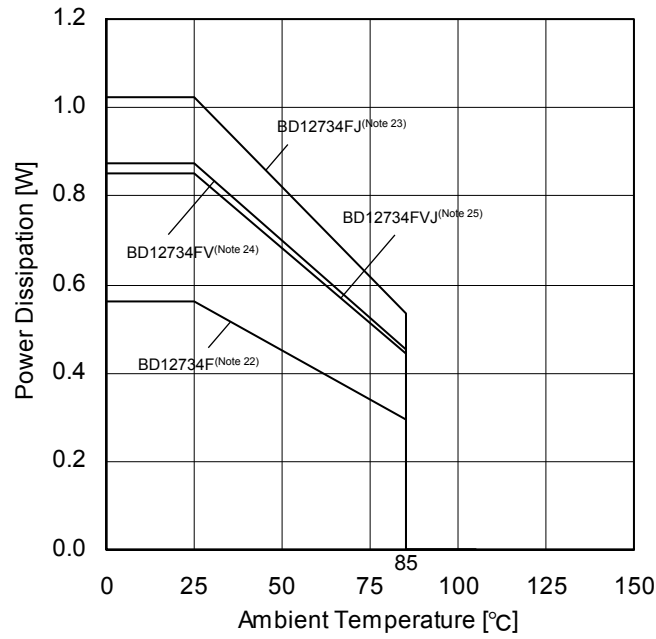

(e) BD12734xxx

(Note 18)	(Note 19)	(Note 20)	(Note 21)	(Note 22)	(Note 23)	(Note 24)	(Note 25)	Unit
5.4	5.5	5.0	4.7	4.5	8.2	7.0	6.8	mW/°C

When using the unit above  $T_A=25^\circ\text{C}$ , subtract the value above per  $^\circ\text{C}$ . Permissible dissipation is the value when FR4 glass epoxy board  $70\text{mm} \times 70\text{mm} \times 1.6\text{mm}$  (copper foil area below 3%) is mounted

Figure 88. Thermal Resistance and Derating Curve

## Operational Notes

### 1. Reverse Connection of Power Supply

Connecting the power supply in reverse polarity can damage the IC. Take precautions against reverse polarity when connecting the power supply, such as mounting an external diode between the power supply and the IC's power supply pins.

### 2. Power Supply Lines

Design the PCB layout pattern to provide low impedance supply lines. Separate the ground and supply lines of the digital and analog blocks to prevent noise in the ground and supply lines of the digital block from affecting the analog block. Furthermore, connect a capacitor to ground at all power supply pins. Consider the effect of temperature and aging on the capacitance value when using electrolytic capacitors.

### 3. Ground Voltage

Ensure that no pins are at a voltage below that of the ground pin at any time, even during transient condition.

### 4. Ground Wiring Pattern

When using both small-signal and large-current ground traces, the two ground traces should be routed separately but connected to a single ground at the reference point of the application board to avoid fluctuations in the small-signal ground caused by large currents. Also ensure that the ground traces of external components do not cause variations on the ground voltage. The ground lines must be as short and thick as possible to reduce line impedance.

### 5. Thermal Consideration

Should by any chance the power dissipation rating be exceeded the rise in temperature of the chip may result in deterioration of the properties of the chip. The absolute maximum rating of the  $P_D$  stated in this specification is when the IC is mounted on a 70mm x 70mm x 1.6mm glass epoxy board. In case of exceeding this absolute maximum rating, increase the board size and copper area to prevent exceeding the  $P_D$  rating.

### 6. Recommended Operating Conditions

These conditions represent a range within which the expected characteristics of the IC can be approximately obtained. The electrical characteristics are guaranteed under the conditions of each parameter.

### 7. Inrush Current

When power is first supplied to the IC, it is possible that the internal logic may be unstable and inrush current may flow instantaneously due to the internal powering sequence and delays, especially if the IC has more than one power supply. Therefore, give special consideration to power coupling capacitance, power wiring, width of ground wiring, and routing of connections.

### 8. Operation Under Strong Electromagnetic Field

Operating the IC in the presence of a strong electromagnetic field may cause the IC to malfunction.

### 9. Testing on Application Boards

When testing the IC on an application board, connecting a capacitor directly to a low-impedance output pin may subject the IC to stress. Always discharge capacitors completely after each process or step. The IC's power supply should always be turned off completely before connecting or removing it from the test setup during the inspection process. To prevent damage from static discharge, ground the IC during assembly and use similar precautions during transport and storage.

### 10. Inter-pin Short and Mounting Errors

Ensure that the direction and position are correct when mounting the IC on the PCB. Incorrect mounting may result in damaging the IC. Avoid nearby pins being shorted to each other especially to ground, power supply and output pin. Inter-pin shorts could be due to many reasons such as metal particles, water droplets (in very humid environment) and unintentional solder bridge deposited in between pins during assembly to name a few.

### 11. Unused Input Pins

Input pins of an IC are often connected to the gate of a MOS transistor. The gate has extremely high impedance and extremely low capacitance. If left unconnected, the electric field from the outside can easily charge it. The small charge acquired in this way is enough to produce a significant effect on the conduction through the transistor and cause unexpected operation of the IC. So, unless otherwise specified, unused input pins should be connected to the power supply or ground line.

## Operational Notes – continued

**12. Regarding the Input Pin of the IC**

This monolithic IC contains P+ isolation and P substrate layers between adjacent elements in order to keep them isolated. P-N junctions are formed at the intersection of the P layers with the N layers of other elements, creating a parasitic diode or transistor. For example (refer to figure below):

When  $GND > Pin A$  and  $GND > Pin B$ , the P-N junction operates as a parasitic diode.

When  $GND > Pin B$ , the P-N junction operates as a parasitic transistor.

Parasitic diodes inevitably occur in the structure of the IC. The operation of parasitic diodes can result in mutual interference among circuits, operational faults, or physical damage. Therefore, conditions that cause these diodes to operate, such as applying a voltage lower than the GND voltage to an input pin (and thus to the P substrate) should be avoided.

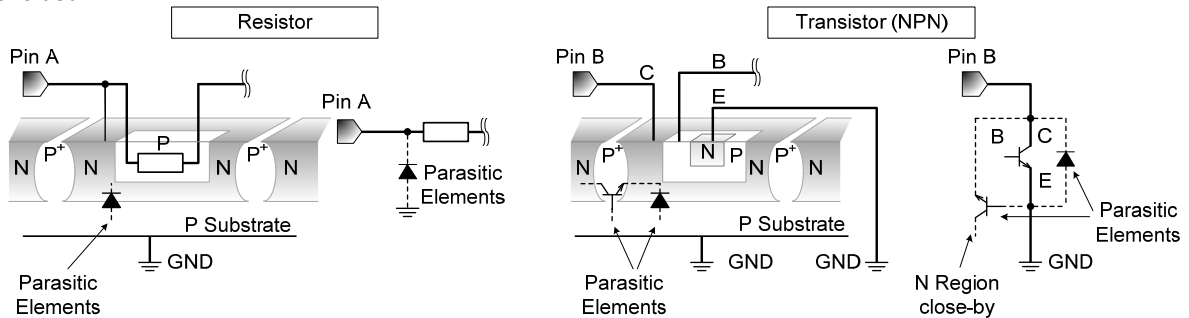

Figure 89. Example of monolithic IC structure

**13. Applied voltage to the input terminal**

For normal circuit operation of voltage comparator, please input voltage for its input terminal within input common mode voltage  $V+ + 0.3V$ . Then, regardless of power supply voltage,  $GND-0.3V$  can be applied to input terminals without deterioration or destruction of its characteristics.

**14. Power supply (single / dual)**

The operational amplifiers operate when the voltage supplied is between  $V+$  and  $GND$ . Therefore, the single supply operational amplifiers can be used as dual supply operational amplifiers as well.

**15. Power dissipation ( $P_d$ )**

Using the unit in excess of the rated power dissipation may cause deterioration in electrical characteristics due to a rise in chip temperature, including reduced current capability. Therefore, please take into consideration the power dissipation ( $P_d$ ) under actual operating conditions and apply a sufficient margin in thermal design. Refer to the thermal derating curves for more information.

**16. IC handling**

Applying mechanical stress to the IC by deflecting or bending the board may cause fluctuations in the electrical characteristics due to piezo resistance effects.

**17. The IC destruction caused by capacitive load**

The transistors in circuits may be damaged when  $V+$  terminal and  $GND$  terminal is shorted with the charged output terminal capacitor. When IC is used as an operational amplifier or as an application circuit, where oscillation is not activated by an output capacitor, the output capacitor must be kept below  $0.1\mu F$  in order to prevent the damage mentioned above.

**18. Latch up**

Be careful in the application of input voltage that exceeds the  $V+$  and  $GND$ . For CMOS device, sometimes latch up operation occurs. Also protect the IC from abnormal noise.

**19. Decoupling capacitor**

Insert a decoupling capacitor between  $V+$  and  $GND$  for a stable operation of the operational amplifier.

## Operational Notes – continued

**20. Unused circuits**

When there are unused Op-amps, it is recommended that they are connected as in Figure 90, setting the non-inverting input terminal to a potential within the Input Common-mode Voltage Range ( $V_{ICM}$ ).

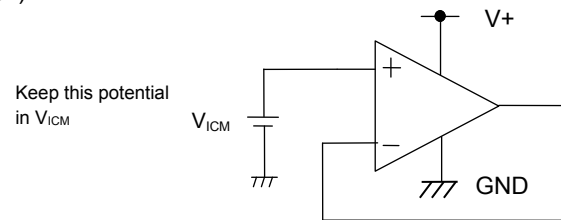
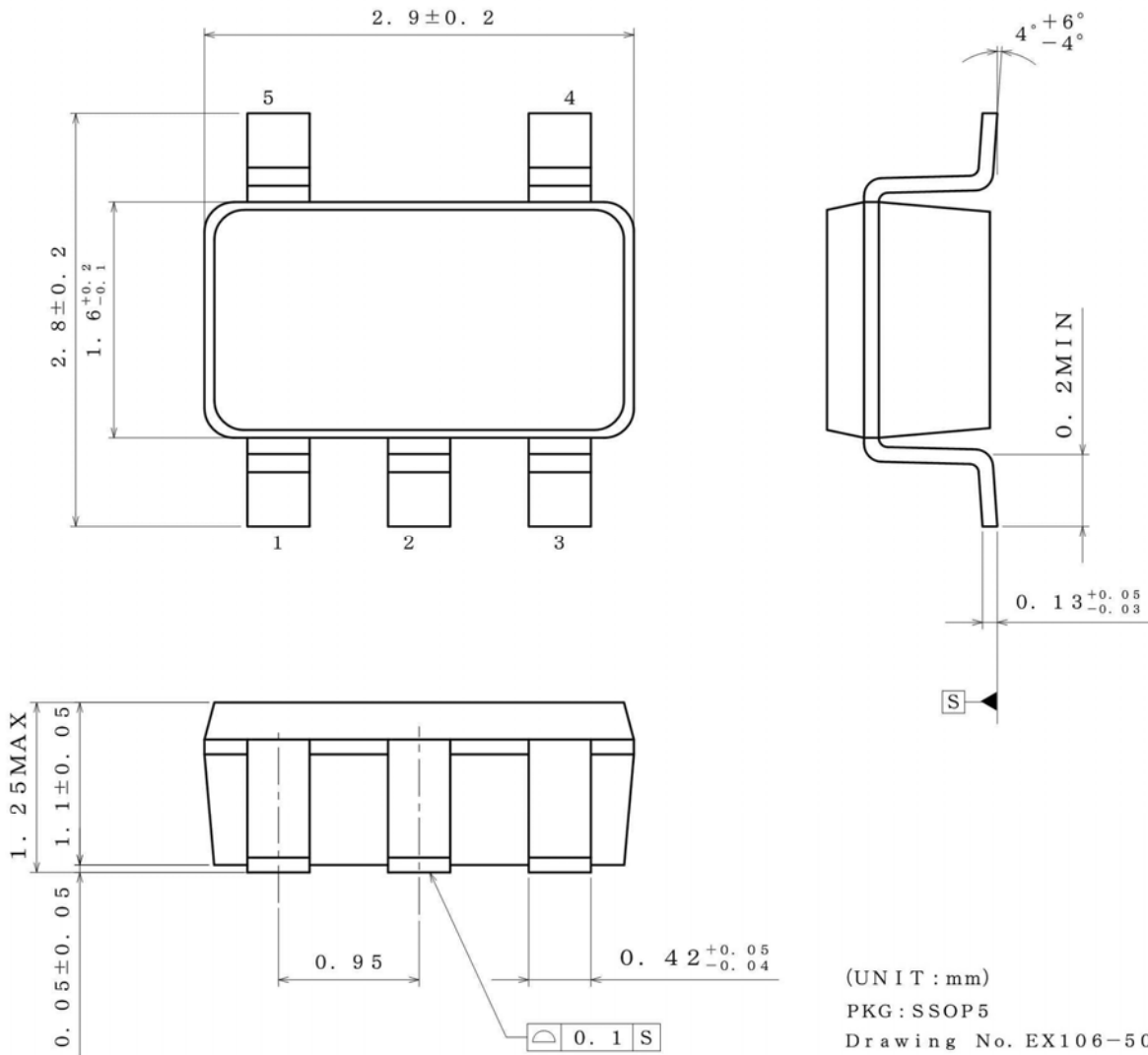

Figure 90. Example of Application Circuit for Unused Op-Amp

Physical Dimension, Tape and Reel Information

Package Name	SSOP5
--------------	-------



< Tape and Reel Information >

Tape	Embossed carrier tape
Quantity	3000pcs
Direction of feed	TL [ The direction is the 1pin of product is at the lower left when you hold reel on the left hand and you pull out the tape on the right hand ]

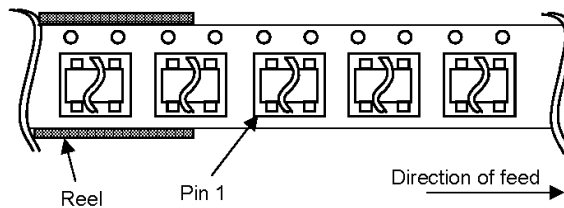

Physical Dimension, Tape and Reel Information - continued

Package Name	SOP8
--------------	------

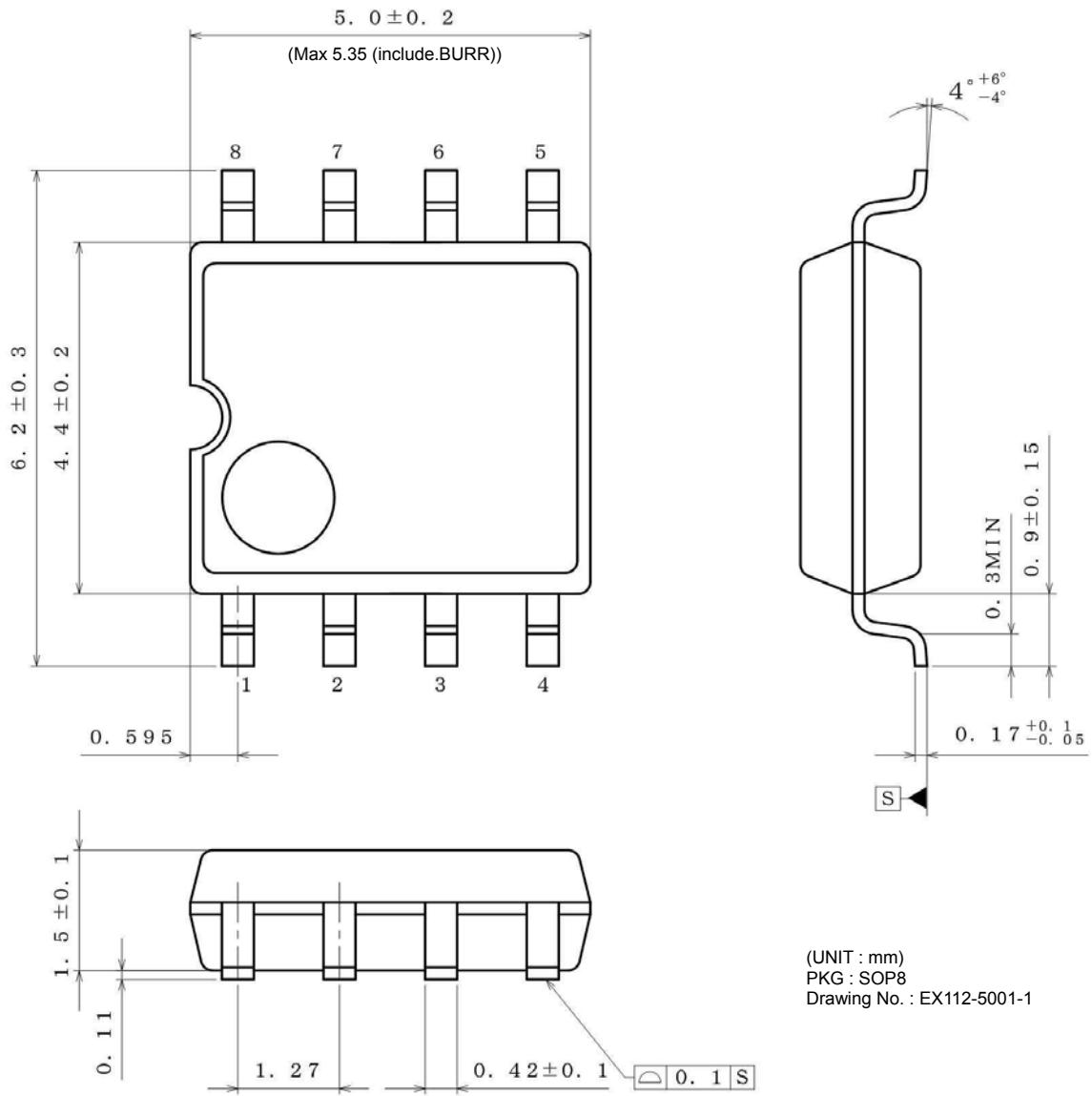

(UNIT : mm)  
 PKG : SOP8  
 Drawing No. : EX112-5001-1

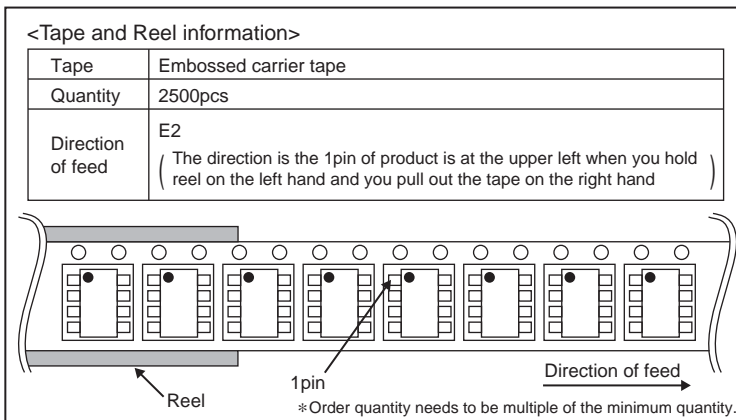

Physical Dimension, Tape and Reel Information - continued

Package Name	SOP-J8
--------------	--------

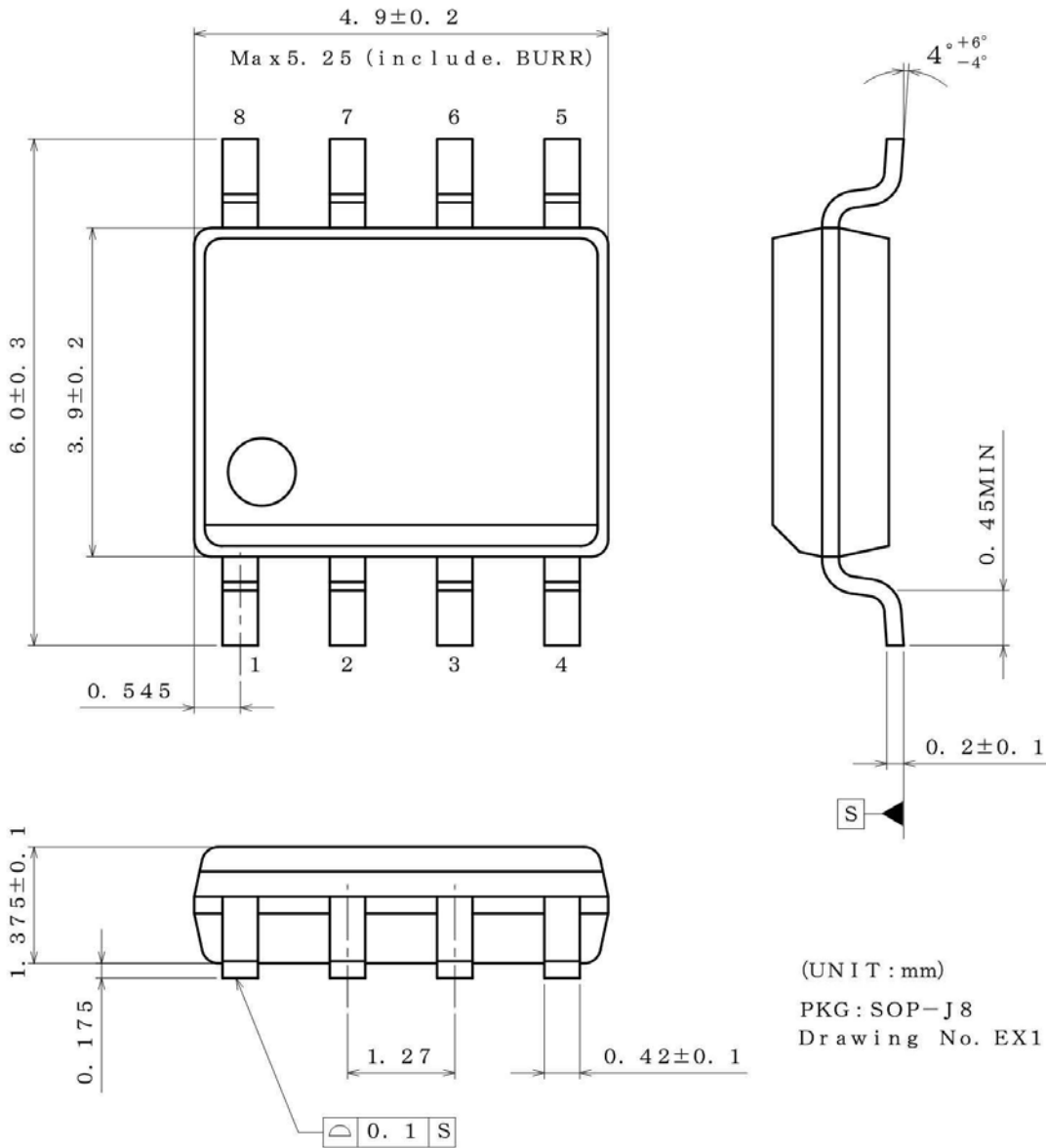

<Tape and Reel information>

Tape	Embossed carrier tape
Quantity	2500pcs
Direction of feed	E2 (The direction is the 1pin of product is at the upper left when you hold reel on the left hand and you pull out the tape on the right hand)

Reel

1pin

Direction of feed

\*Order quantity needs to be multiple of the minimum quantity.

Physical Dimension, Tape and Reel Information - continued

Package Name	SSOP-B8
--------------	---------

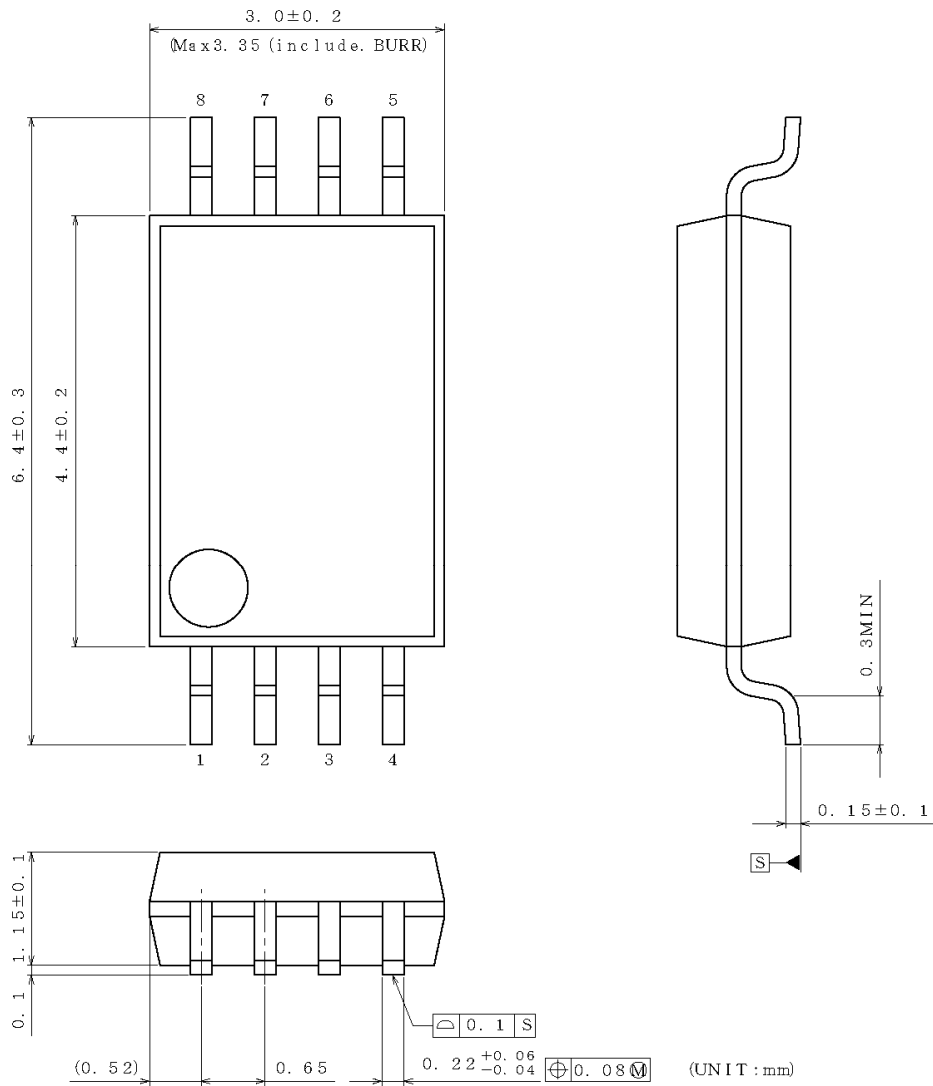

PKG : SSOP-B8  
 Drawing No. EX151-5002

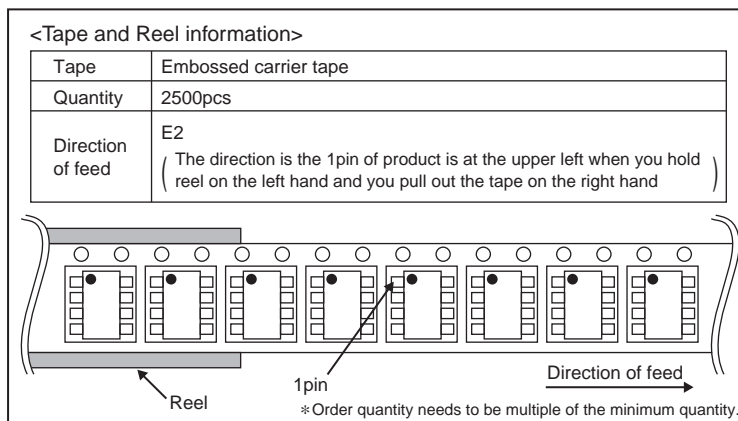



Physical Dimension, Tape and Reel Information - continued

Package Name	TSSOP-B8
--------------	----------

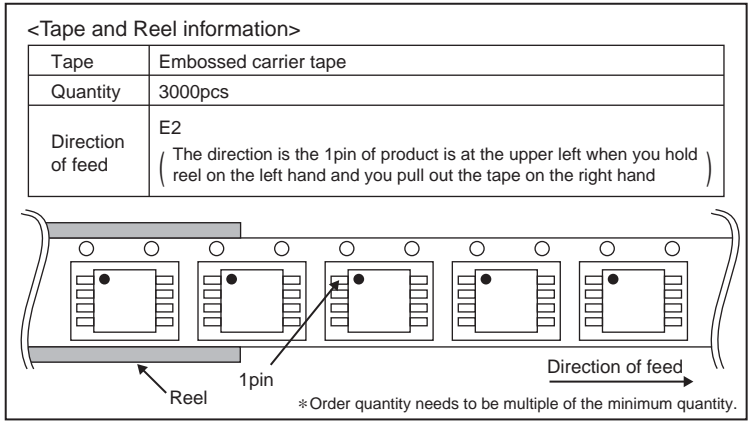
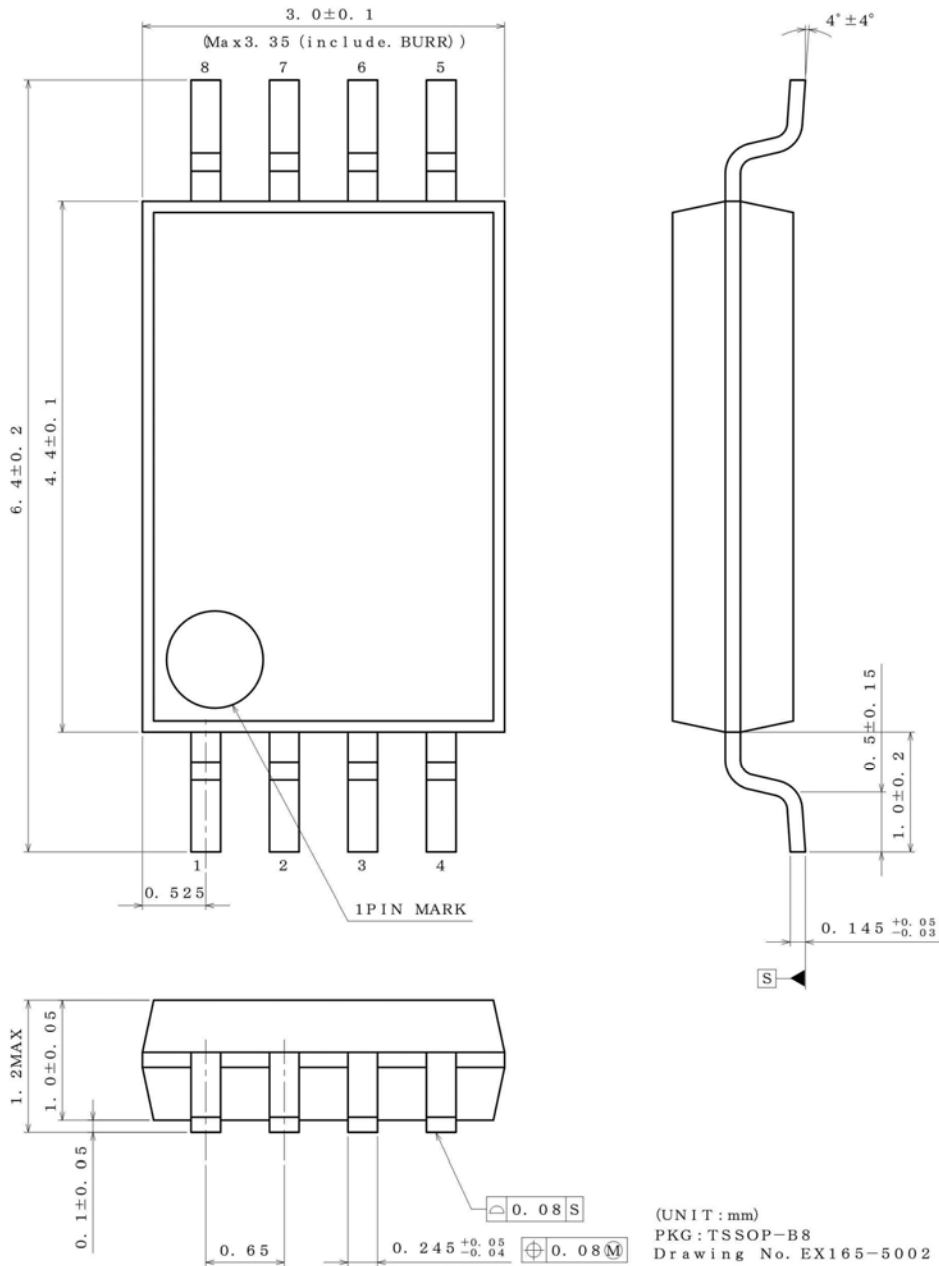

Physical Dimension, Tape and Reel Information - continued

Package Name	MSOP8
--------------	-------

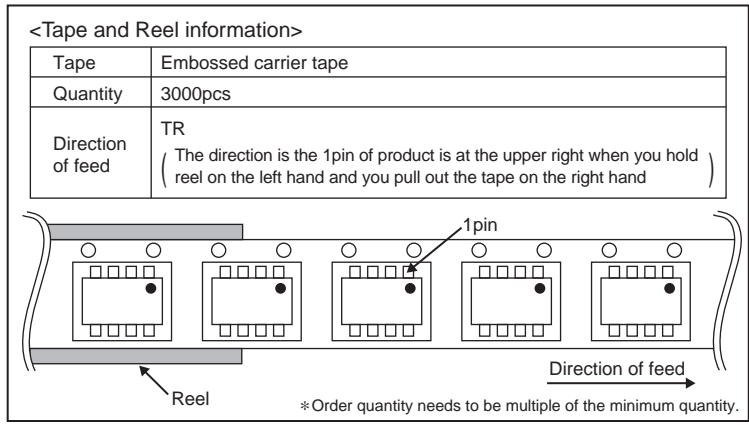
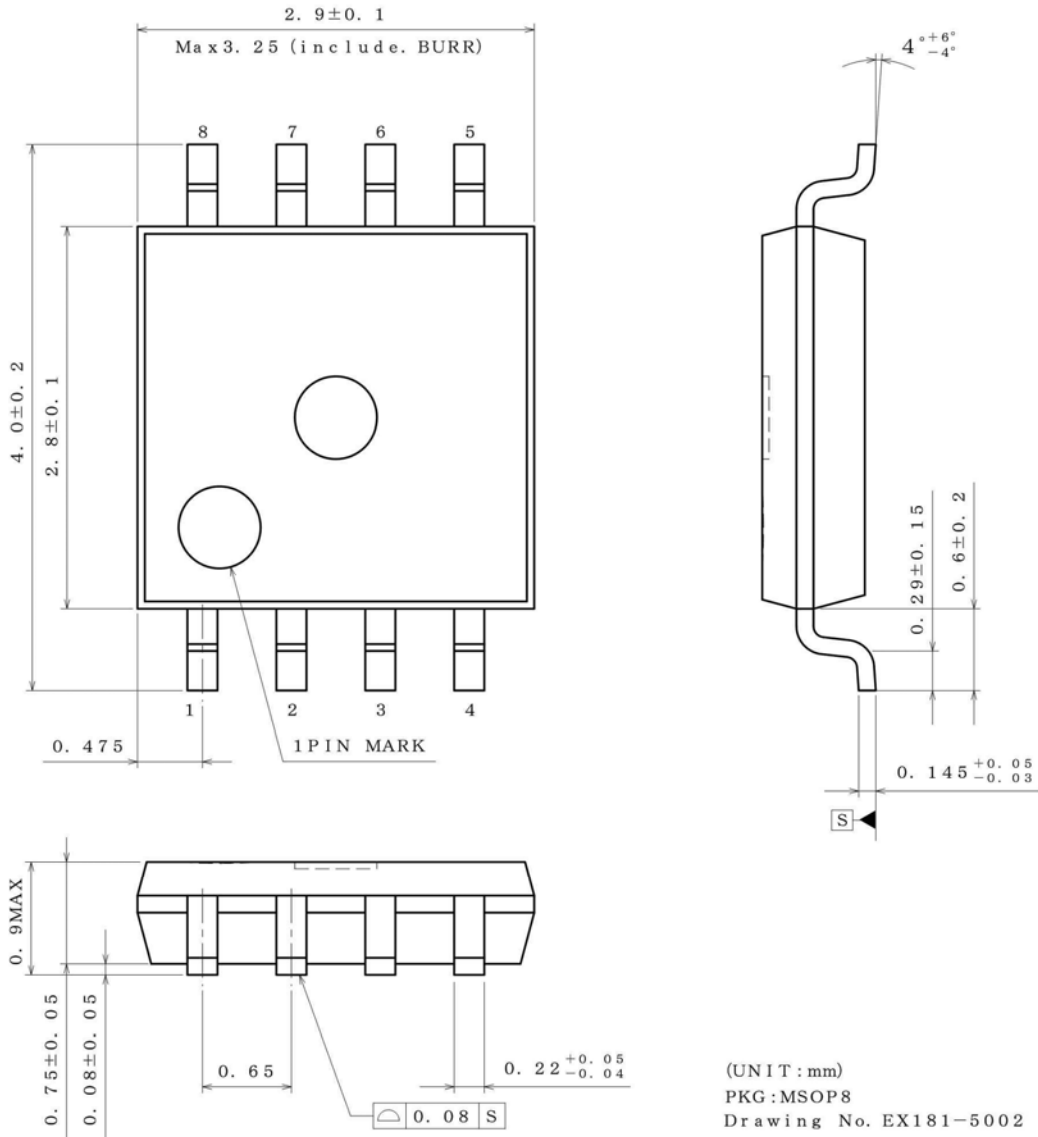

Physical Dimension, Tape and Reel Information - continued

Package Name	TSSOP-B8J
--------------	-----------

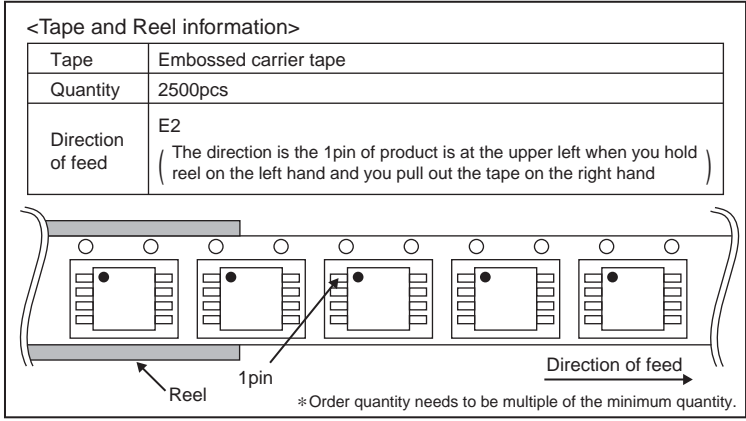
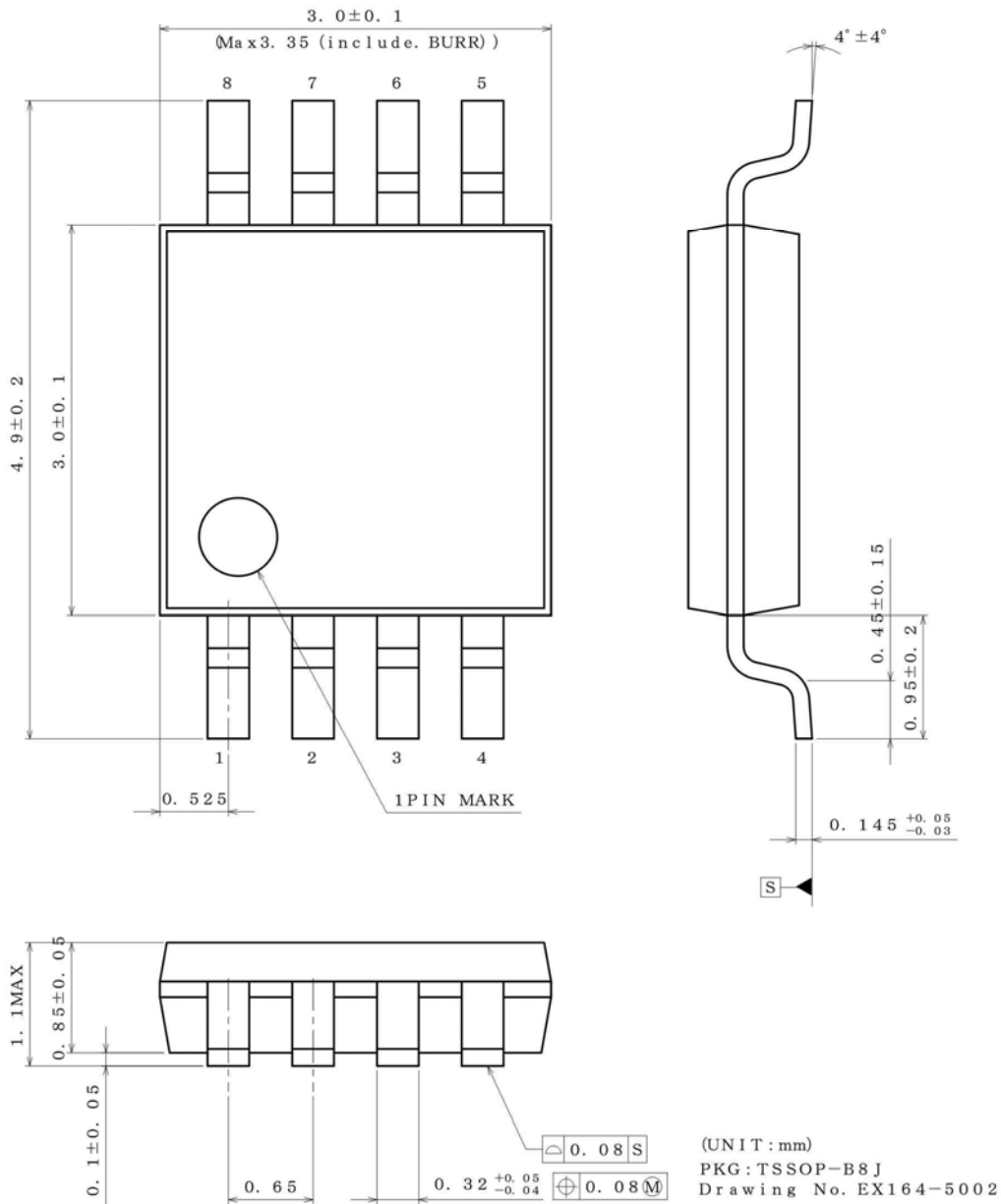

Physical Dimension, Tape and Reel Information - continued

Package Name	SOP14
--------------	-------

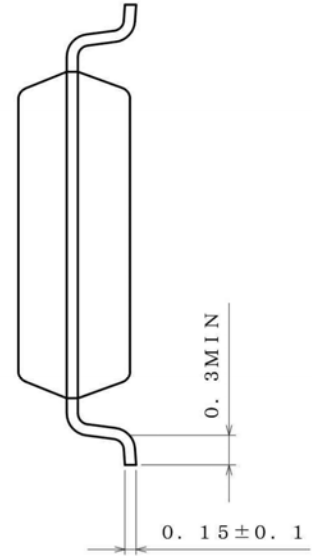
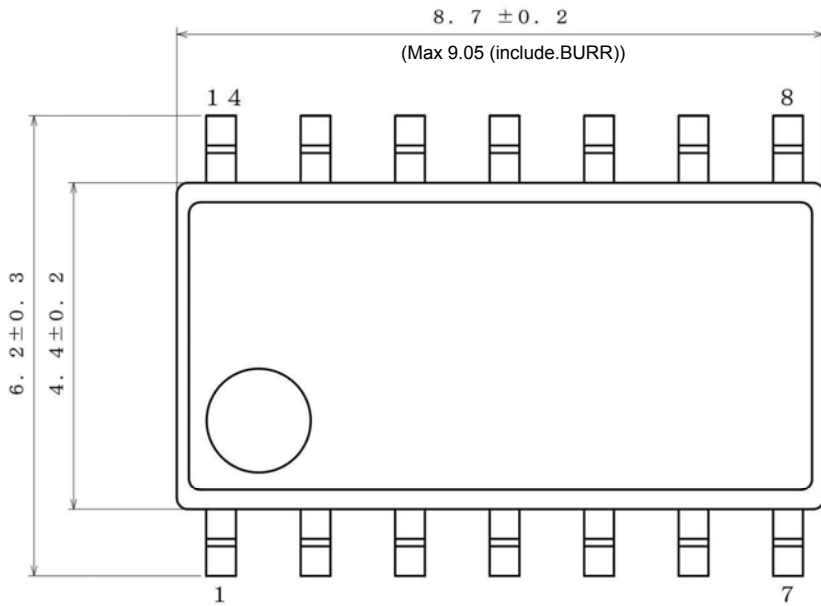

(UNIT : mm)  
 PKG : SOP14  
 Drawing No. : EX113-5001

<Tape and Reel information>

Tape	Embossed carrier tape
Quantity	2500pcs
Direction of feed	E2 ( The direction is the 1pin of product is at the upper left when you hold reel on the left hand and you pull out the tape on the right hand )

Reel

1pin

Direction of feed

\*Order quantity needs to be multiple of the minimum quantity.

Physical Dimension, Tape and Reel Information - continued

Package Name	SOP-J14
--------------	---------

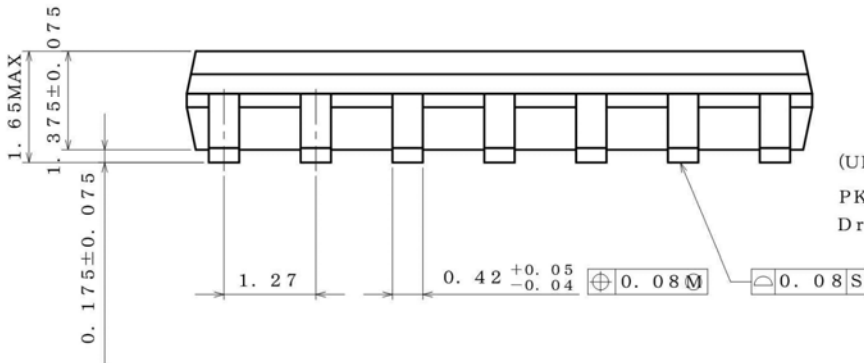
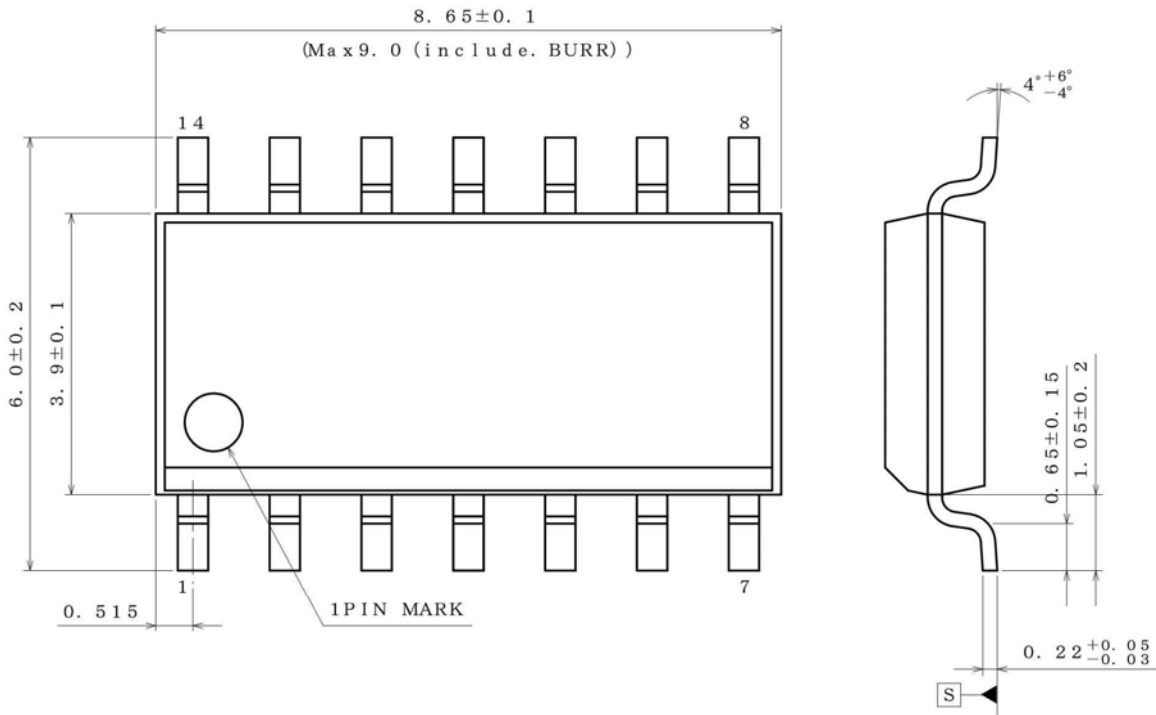

(UNIT : mm)  
 PKG : SOP-J14  
 Drawing No. EX126-5002-1

<Tape and Reel information>

Tape	Embossed carrier tape
Quantity	2500pcs
Direction of feed	E2 ( The direction is the 1pin of product is at the upper left when you hold reel on the left hand and you pull out the tape on the right hand )

1pin  
 \*Order quantity needs to be multiple of the minimum quantity.

Physical Dimension, Tape and Reel Information - continued

Package Name	SSOP-B14
--------------	----------

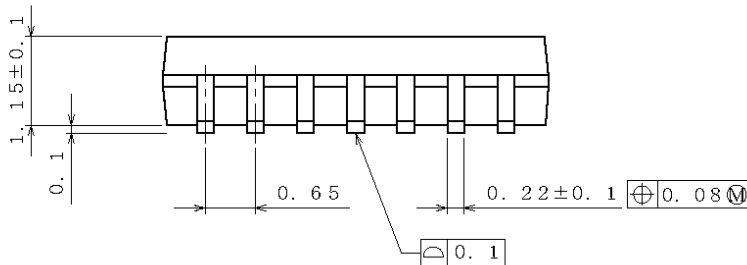
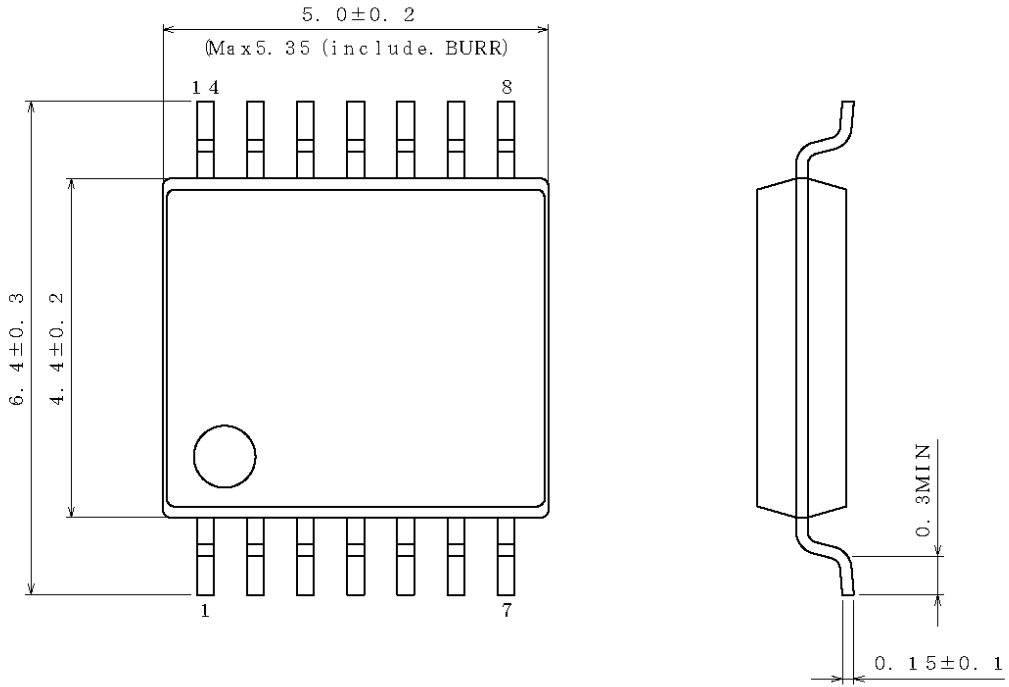

(UNIT : mm)  
 PKG : SSOP-B14  
 Drawing No. EX152-5002

<Tape and Reel information>

Tape	Embossed carrier tape
Quantity	2500pcs
Direction of feed	E2 ( The direction is the 1pin of product is at the upper left when you hold reel on the left hand and you pull out the tape on the right hand )

Reel      1pin      Direction of feed

\*Order quantity needs to be multiple of the minimum quantity.

Physical Dimension, Tape and Reel Information - continued

Package Name	TSSOP-B14J
--------------	------------

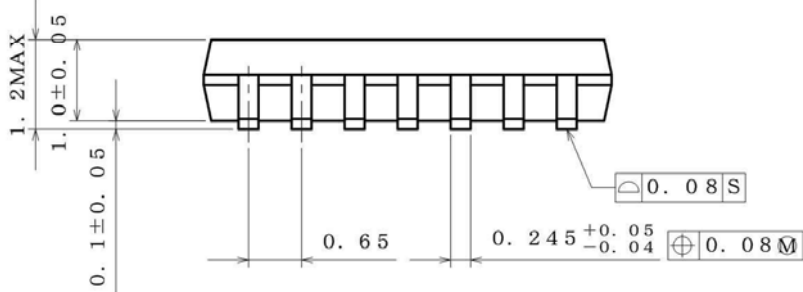
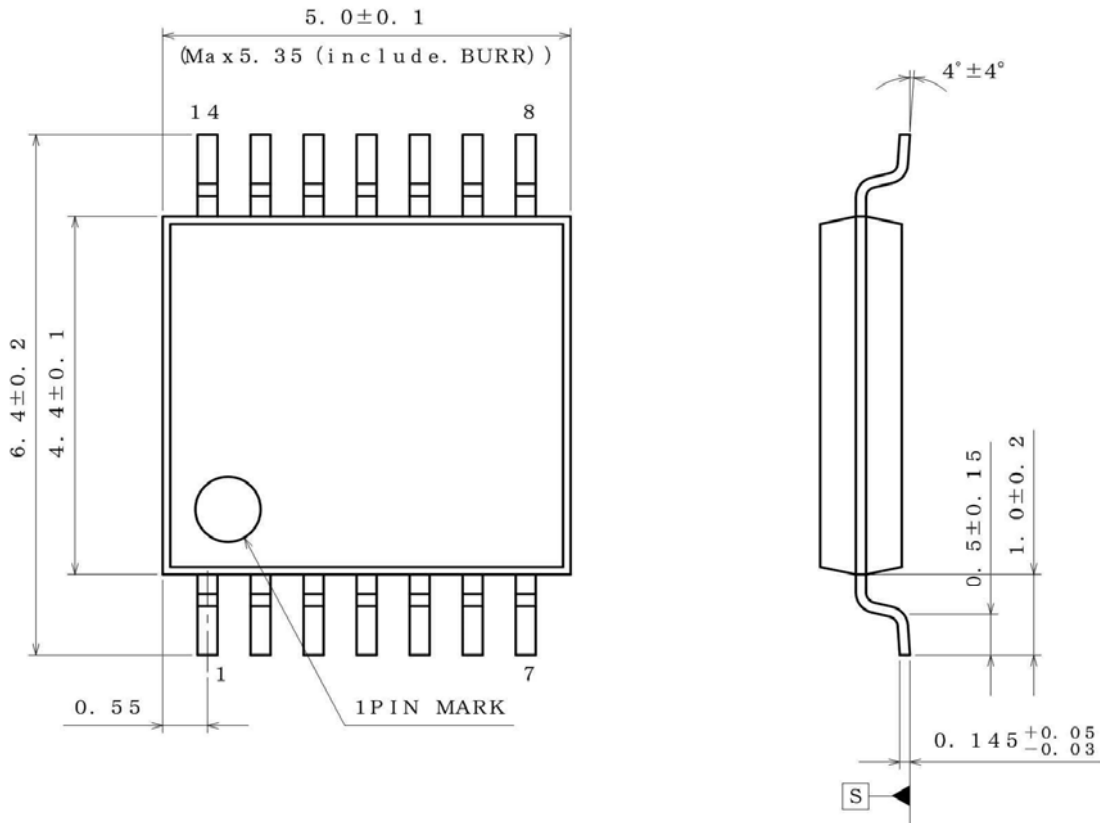

(UNIT : mm)  
 PKG : TSSOP-B14J  
 Drawing No. EX166-5002-1

<Tape and Reel information>

Tape	Embossed carrier tape
Quantity	2500pcs
Direction of feed	E2 ( The direction is the 1pin of product is at the upper left when you hold reel on the left hand and you pull out the tape on the right hand )

Reel 1pin Direction of feed

\*Order quantity needs to be multiple of the minimum quantity.

Marking Diagram

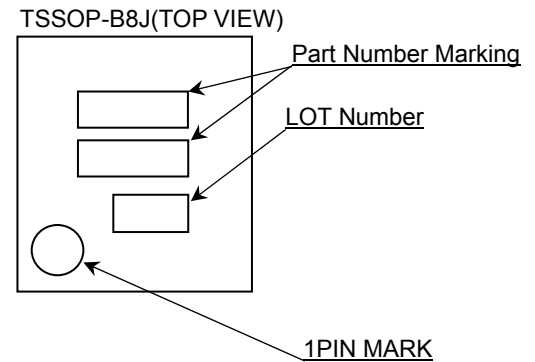
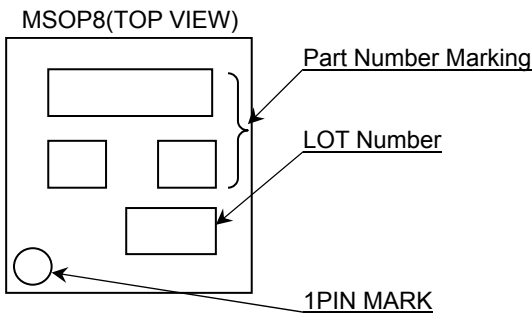
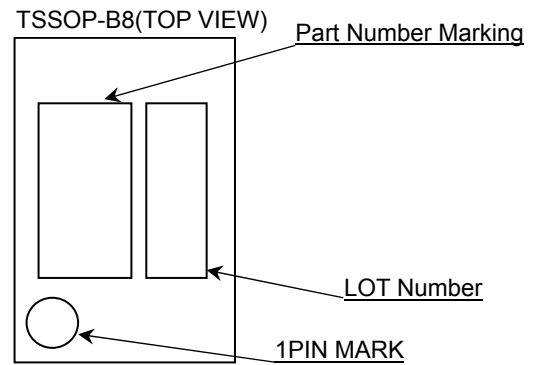
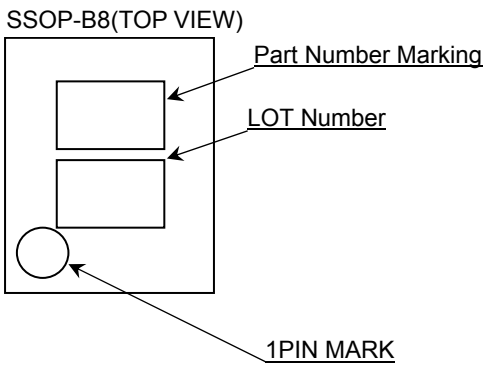
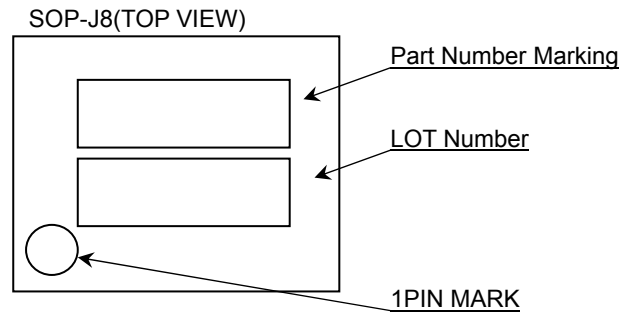
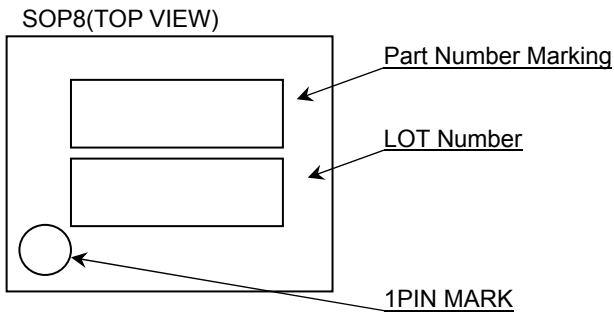
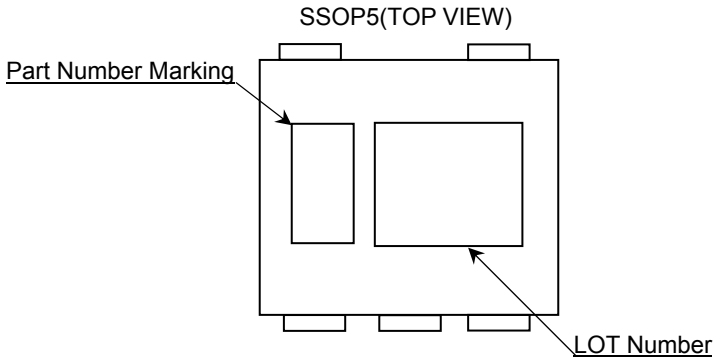



Marking Diagram - continued

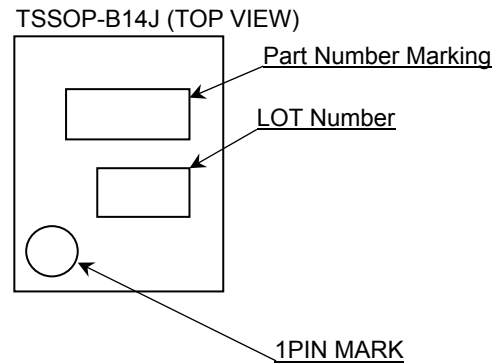
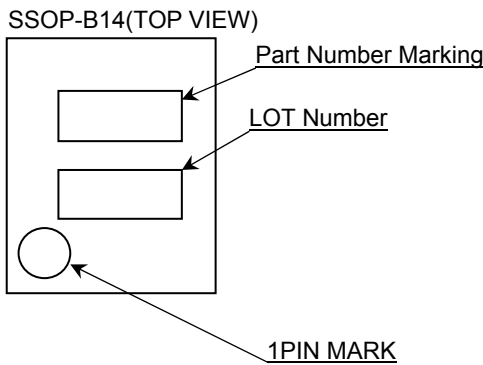
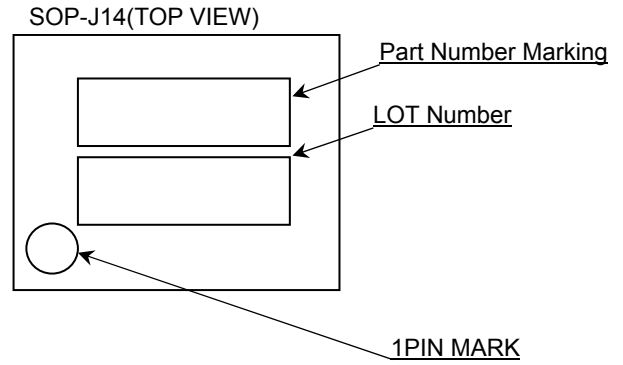
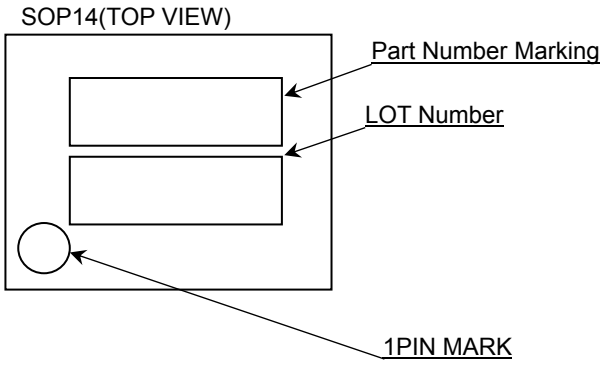

Product Name		Package Type	Marking
BD12730	G	SSOP5	K7
BD12732	F	SOP8	D2732
	FJ	SOP-J8	D2732
	FV	SSOP-B8	2732
	FVT	TSSOP-B8	D2732
	FVM	MSOP8	D2732
	FVJ	TSSOP-B8J	D2732
BD12734	F	SOP14	BD12734F
	FJ	SOP-J14	D2734
	FV	SSOP-B14	D2734
	FVM	TSSOP-B14J	D2734

**Revision History**

Date	Revision	Changes
30.Nov.2013	001	New Release
11.Feb.2013	002	Added BD12732F and BD12734F
1.Apr.2014	003	BD12732FJ/FV/FVT/FVM/FVJ and BD12734FJ/FV/FVJ package variation added
4.July.2016	004	Change Operating Voltage Range Before:1.8V to 5V After:1.8V to 5.5V, Correction of erroneous description(P.28)
14.July.2016	005	Key Specifications : Temperature Range → Operating Temperature Range(P.1) Line-up : T <sub>opr</sub> → Operating Temperature(P.3) Delete Land Pattern Data(P.50) Correction of erroneous description (P.49 Diagr-m → Diagram)

# Notice

## Precaution on using ROHM Products

- Our Products are designed and manufactured for application in ordinary electronic equipments (such as AV equipment, OA equipment, telecommunication equipment, home electronic appliances, amusement equipment, etc.). If you intend to use our Products in devices requiring extremely high reliability (such as medical equipment <sup>(Note 1)</sup>, transport equipment, traffic equipment, aircraft/spacecraft, nuclear power controllers, fuel controllers, car equipment including car accessories, safety devices, etc.) and whose malfunction or failure may cause loss of human life, bodily injury or serious damage to property ("Specific Applications"), please consult with the ROHM sales representative in advance. Unless otherwise agreed in writing by ROHM in advance, ROHM shall not be in any way responsible or liable for any damages, expenses or losses incurred by you or third parties arising from the use of any ROHM's Products for Specific Applications.

(Note1) Medical Equipment Classification of the Specific Applications

JAPAN	USA	EU	CHINA
CLASS III	CLASS III	CLASS II b	CLASS III
CLASS IV		CLASS III	

- ROHM designs and manufactures its Products subject to strict quality control system. However, semiconductor products can fail or malfunction at a certain rate. Please be sure to implement, at your own responsibilities, adequate safety measures including but not limited to fail-safe design against the physical injury, damage to any property, which a failure or malfunction of our Products may cause. The following are examples of safety measures:
  - Installation of protection circuits or other protective devices to improve system safety
  - Installation of redundant circuits to reduce the impact of single or multiple circuit failure
- Our Products are designed and manufactured for use under standard conditions and not under any special or extraordinary environments or conditions, as exemplified below. Accordingly, ROHM shall not be in any way responsible or liable for any damages, expenses or losses arising from the use of any ROHM's Products under any special or extraordinary environments or conditions. If you intend to use our Products under any special or extraordinary environments or conditions (as exemplified below), your independent verification and confirmation of product performance, reliability, etc. prior to use, must be necessary:
  - Use of our Products in any types of liquid, including water, oils, chemicals, and organic solvents
  - Use of our Products outdoors or in places where the Products are exposed to direct sunlight or dust
  - Use of our Products in places where the Products are exposed to sea wind or corrosive gases, including Cl<sub>2</sub>, H<sub>2</sub>S, NH<sub>3</sub>, SO<sub>2</sub>, and NO<sub>2</sub>
  - Use of our Products in places where the Products are exposed to static electricity or electromagnetic waves
  - Use of our Products in proximity to heat-producing components, plastic cords, or other flammable items
  - Sealing or coating our Products with resin or other coating materials
  - Use of our Products without cleaning residue of flux (even if you use no-clean type fluxes, cleaning residue of flux is recommended); or Washing our Products by using water or water-soluble cleaning agents for cleaning residue after soldering
  - Use of the Products in places subject to dew condensation
- The Products are not subject to radiation-proof design.
- Please verify and confirm characteristics of the final or mounted products in using the Products.
- In particular, if a transient load (a large amount of load applied in a short period of time, such as pulse. is applied, confirmation of performance characteristics after on-board mounting is strongly recommended. Avoid applying power exceeding normal rated power; exceeding the power rating under steady-state loading condition may negatively affect product performance and reliability.
- De-rate Power Dissipation depending on ambient temperature. When used in sealed area, confirm that it is the use in the range that does not exceed the maximum junction temperature.
- Confirm that operation temperature is within the specified range described in the product specification.
- ROHM shall not be in any way responsible or liable for failure induced under deviant condition from what is defined in this document.

## Precaution for Mounting / Circuit board design

- When a highly active halogenous (chlorine, bromine, etc.) flux is used, the residue of flux may negatively affect product performance and reliability.
- In principle, the reflow soldering method must be used on a surface-mount products, the flow soldering method must be used on a through hole mount products. If the flow soldering method is preferred on a surface-mount products, please consult with the ROHM representative in advance.

For details, please refer to ROHM Mounting specification

### Precautions Regarding Application Examples and External Circuits

1. If change is made to the constant of an external circuit, please allow a sufficient margin considering variations of the characteristics of the Products and external components, including transient characteristics, as well as static characteristics.
2. You agree that application notes, reference designs, and associated data and information contained in this document are presented only as guidance for Products use. Therefore, in case you use such information, you are solely responsible for it and you must exercise your own independent verification and judgment in the use of such information contained in this document. ROHM shall not be in any way responsible or liable for any damages, expenses or losses incurred by you or third parties arising from the use of such information.

### Precaution for Electrostatic

This Product is electrostatic sensitive product, which may be damaged due to electrostatic discharge. Please take proper caution in your manufacturing process and storage so that voltage exceeding the Products maximum rating will not be applied to Products. Please take special care under dry condition (e.g. Grounding of human body / equipment / solder iron, isolation from charged objects, setting of ionizer, friction prevention and temperature / humidity control).

### Precaution for Storage / Transportation

1. Product performance and soldered connections may deteriorate if the Products are stored in the places where:
  - [a] the Products are exposed to sea winds or corrosive gases, including Cl<sub>2</sub>, H<sub>2</sub>S, NH<sub>3</sub>, SO<sub>2</sub>, and NO<sub>2</sub>
  - [b] the temperature or humidity exceeds those recommended by ROHM
  - [c] the Products are exposed to direct sunshine or condensation
  - [d] the Products are exposed to high Electrostatic
2. Even under ROHM recommended storage condition, solderability of products out of recommended storage time period may be degraded. It is strongly recommended to confirm solderability before using Products of which storage time is exceeding the recommended storage time period.
3. Store / transport cartons in the correct direction, which is indicated on a carton with a symbol. Otherwise bent leads may occur due to excessive stress applied when dropping of a carton.
4. Use Products within the specified time after opening a humidity barrier bag. Baking is required before using Products of which storage time is exceeding the recommended storage time period.

### Precaution for Product Label

A two-dimensional barcode printed on ROHM Products label is for ROHM's internal use only.

### Precaution for Disposition

When disposing Products please dispose them properly using an authorized industry waste company.

### Precaution for Foreign Exchange and Foreign Trade act

Since concerned goods might be fallen under listed items of export control prescribed by Foreign exchange and Foreign trade act, please consult with ROHM in case of export.

### Precaution Regarding Intellectual Property Rights

1. All information and data including but not limited to application example contained in this document is for reference only. ROHM does not warrant that foregoing information or data will not infringe any intellectual property rights or any other rights of any third party regarding such information or data.
2. ROHM shall not have any obligations where the claims, actions or demands arising from the combination of the Products with other articles such as components, circuits, systems or external equipment (including software).
3. No license, expressly or implied, is granted hereby under any intellectual property rights or other rights of ROHM or any third parties with respect to the Products or the information contained in this document. Provided, however, that ROHM will not assert its intellectual property rights or other rights against you or your customers to the extent necessary to manufacture or sell products containing the Products, subject to the terms and conditions herein.

### Other Precaution

1. This document may not be reprinted or reproduced, in whole or in part, without prior written consent of ROHM.
2. The Products may not be disassembled, converted, modified, reproduced or otherwise changed without prior written consent of ROHM.
3. In no event shall you use in any way whatsoever the Products and the related technical information contained in the Products or this document for any military purposes, including but not limited to, the development of mass-destruction weapons.
4. The proper names of companies or products described in this document are trademarks or registered trademarks of ROHM, its affiliated companies or third parties.

**General Precaution**

1. Before you use our Products, you are requested to carefully read this document and fully understand its contents. ROHM shall not be in any way responsible or liable for failure, malfunction or accident arising from the use of any ROHM's Products against warning, caution or note contained in this document.
2. All information contained in this document is current as of the issuing date and subject to change without any prior notice. Before purchasing or using ROHM's Products, please confirm the latest information with a ROHM sales representative.
3. The information contained in this document is provided on an "as is" basis and ROHM does not warrant that all information contained in this document is accurate and/or error-free. ROHM shall not be in any way responsible or liable for any damages, expenses or losses incurred by you or third parties resulting from inaccuracy or errors of or concerning such information.