

FM140-MH1 THRU FM1200-MH1

List

List..... 1

Package outline..... 2

Features..... 2

Mechanical data..... 2

Maximum ratings 2

Rating and characteristic curves..... 3

Pinning information..... 4

Marking..... 4

Suggested solder pad layout..... 4

Packing information..... 5

Reel packing..... 6

Suggested thermal profiles for soldering processes..... 6

High reliability test capabilities..... 7

FM140-MH1 THRU FM1200-MH1

1.0A Surface Mount Schottky Barrier Rectifiers - 40V-200V

Features

- Batch process design, excellent power dissipation offers better reverse leakage current and thermal resistance.
- Low profile surface mounted application in order to optimize board space.
- Low power loss, high efficiency.
- High current capability, low forward voltage drop.
- High surge capability.
- Guardring for overvoltage protection.
- Ultra high-speed switching.
- Silicon epitaxial planar chip, metal silicon junction.
- Lead-free parts meet environmental standards of MIL-STD-19500 /228
- Suffix "-H" indicates Halogen free parts, ex. FM140-MH1-H.

Mechanical data

- Epoxy : UL94-V0 rated flame retardant
- Case : Molded plastic, SOD-123H1
- Terminals :Plated terminals, solderable per MIL-STD-750, Method 2026
- Polarity : Indicated by cathode band
- Mounting Position : Any
- Weight : Approximated 0.0103 gram

Package outline

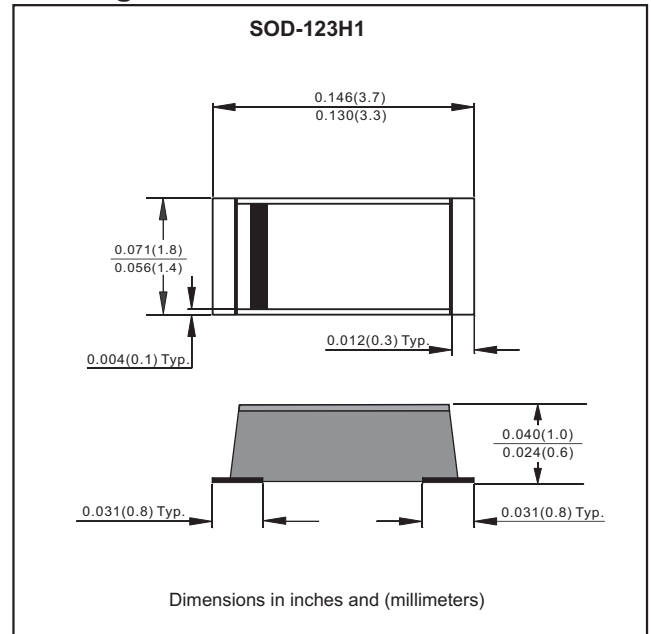

Maximum ratings and Electrical Characteristics (AT $T_A=25^\circ\text{C}$ unless otherwise noted)

PARAMETER	SYMBOLS	FM140-MH1	FM160-MH1	FM1100-MH1	FM1150-MH1	FM1200-MH1	UNITS
Maximum repetitive peak reverse voltage	V_{RRM}	40	60	100	150	200	Volts
Maximum RMS voltage	V_{RMS}	28	42	70	105	140	Volts
Maximum DC blocking voltage	V_{DC}	40	60	100	150	200	Volts
Maximum average forward rectified current	I_o	1.0					Amps
Peak forward surge current 8.3ms single half sine-wave (JEDEC Method)	I_{FSM}	30					Amps
Maximum instantaneous forward voltage at $I_F=1.0A$	V_F	0.50	0.70	0.85	0.90	0.92	Volts
Maximum DC reverse current at rated DC blocking voltage	I_R	0.5 10					$^\circ\text{C} / \text{W}$ $^\circ\text{C} / \text{W}$
Typical junction capacitance (Note 1)	C_J	120					pF
Typical thermal resistance junction to ambient	$R_{\theta JA}$	80					$^\circ\text{C} / \text{W}$
Typical thermal resistance junction to case	$R_{\theta JC}$	40					$^\circ\text{C} / \text{W}$
Operating junction temperature range	T_J	-55 to +125	-55 to +150				$^\circ\text{C}$
Storage temperature range	T_{STG}	-55 to +150					$^\circ\text{C}$

Notes 1: Measured at 1.0 MHz and applied reverse voltage of 4.0 Volts

Rating and characteristic curves (FM140-MH1 THRU FM1200-MH1)

FIG.1-TYPICAL FORWARD CURRENT DERATING CURVE

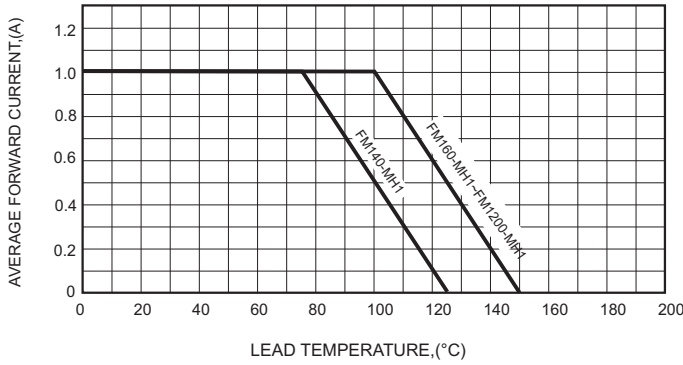

FIG.2-TYPICAL FORWARD CHARACTERISTICS

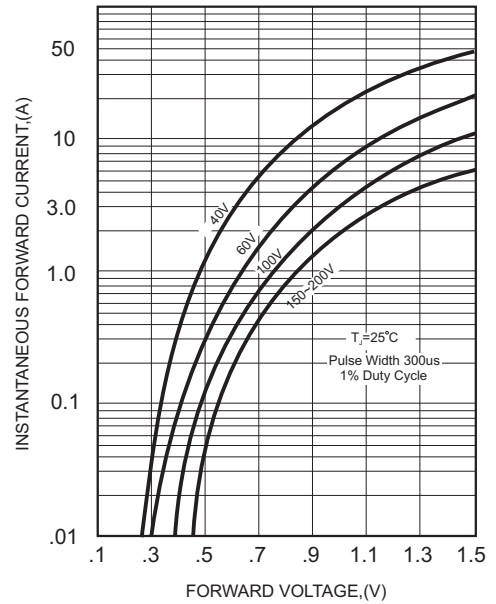

FIG.3-MAXIMUM NON-REPETITIVE FORWARD SURGE CURRENT

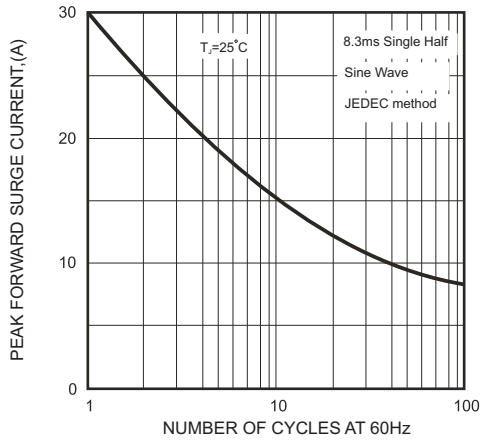

FIG.4-TYPICAL JUNCTION CAPACITANCE

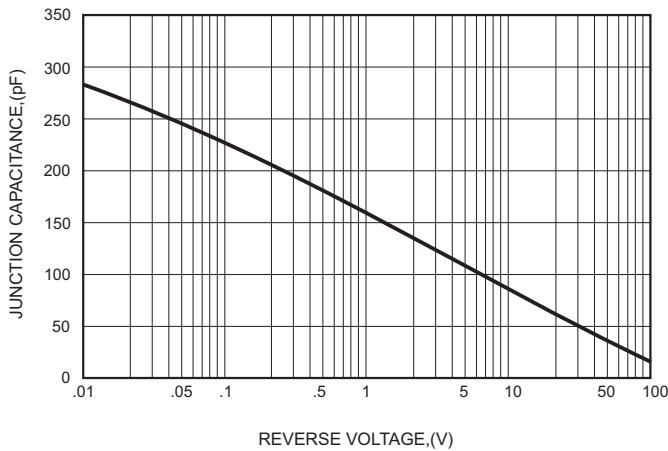
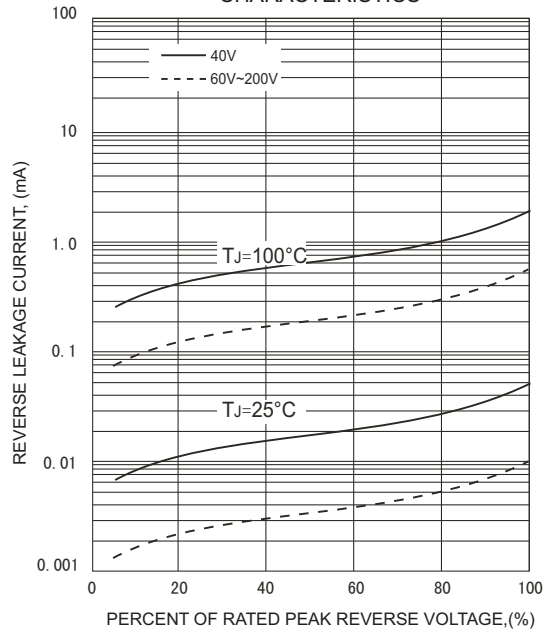



FIG.5 - TYPICAL REVERSE CHARACTERISTICS



FM140-MH1 THRU FM1200-MH1

Pinning information

Pin	Simplified outline	Symbol
Pin1 cathode Pin2 anode		

Marking

Type number	Marking code
FM140-MH1	14
FM160-MH1	16
FM1100-MH1	10
FM1150-MH1	115
FM1200-MH1	120

Suggested solder pad layout



Dimensions in inches and (millimeters)

PACKAGE	A	B	C
SOD-123H1	0.071 (1.80)	0.051 (1.30)	0.067 (1.70)

FM140-MH1 THRU FM1200-MH1

Packing information

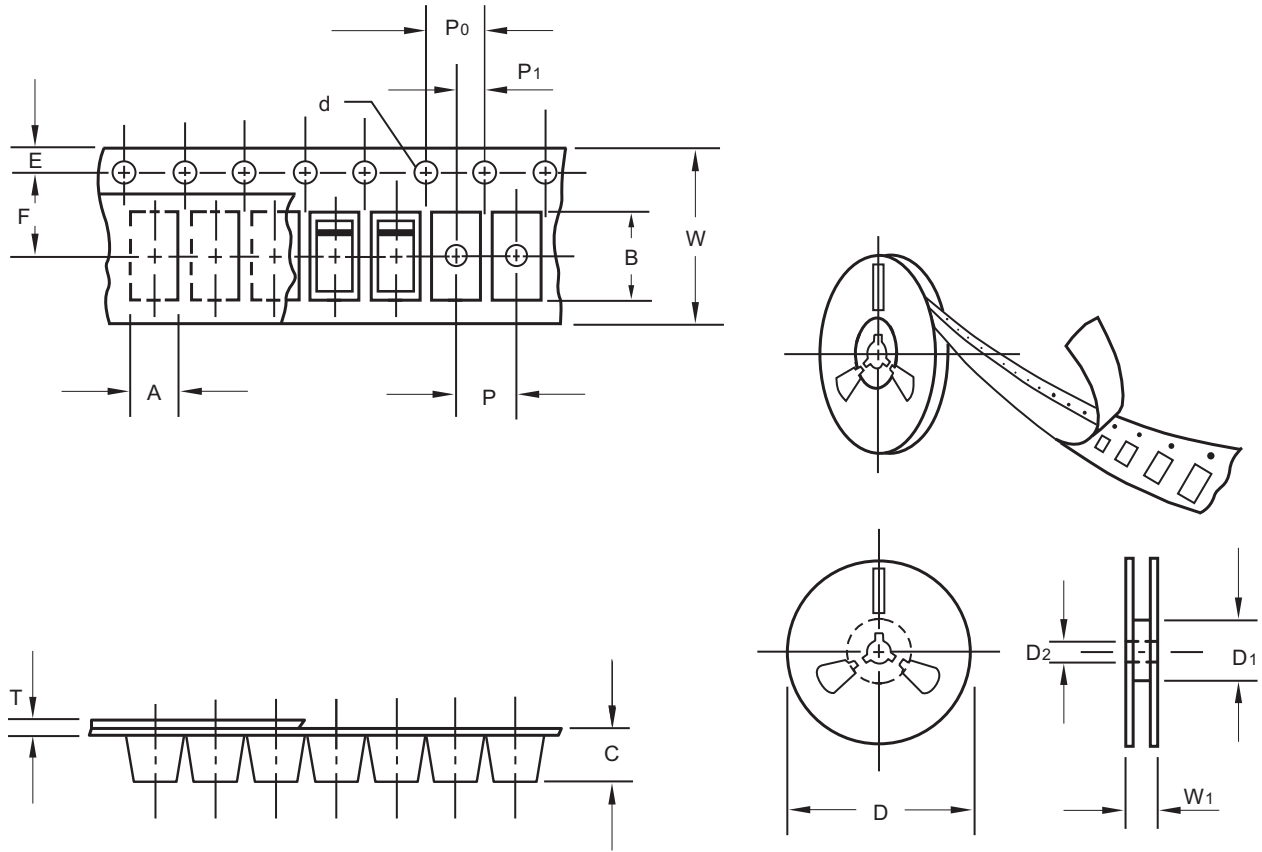

unit:mm

Item	Symbol	Tolerance	SOD-123H1
Carrier width	A	0.1	2.00
Carrier length	B	0.1	3.85
Carrier depth	C	0.1	1.10
Sprocket hole	d	0.1	1.50
13" Reel outside diameter	D	2.0	-
13" Reel inner diameter	D1	min	-
7" Reel outside diameter	D	2.0	178.00
7" Reel inner diameter	D1	min	62.00
Feed hole diameter	D2	0.5	13.00
Sprocket hole position	E	0.1	1.75
Punch hole position	F	0.1	3.50
Punch hole pitch	P	0.1	4.00
Sprocket hole pitch	P0	0.1	4.00
Embossment center	P1	0.1	2.00
Overall tape thickness	T	0.1	0.23
Tape width	W	0.3	8.00
Reel width	W1	1.0	11.40

Note: Devices are packed in accordance with EIA standard RS-481-A and specifications listed above.

FM140-MH1 THRU FM1200-MH1

Reel packing

PACKAGE	REEL SIZE	REEL (pcs)	COMPONENT SPACING (m/m)	BOX (pcs)	INNER BOX (m/m)	REEL DIA, (m/m)	CARTON SIZE (m/m)	CARTON (pcs)	APPROX. GROSS WEIGHT (kg)
SOD-123H1	7"	3,000	4.0	30,000	183*183*123	178	382*262*387	240,000	8.5

Suggested thermal profiles for soldering processes

- 1.Storage environment: Temperature=5°C~40°C Humidity=55%±25%
- 2.Reflow soldering of surface-mount devices

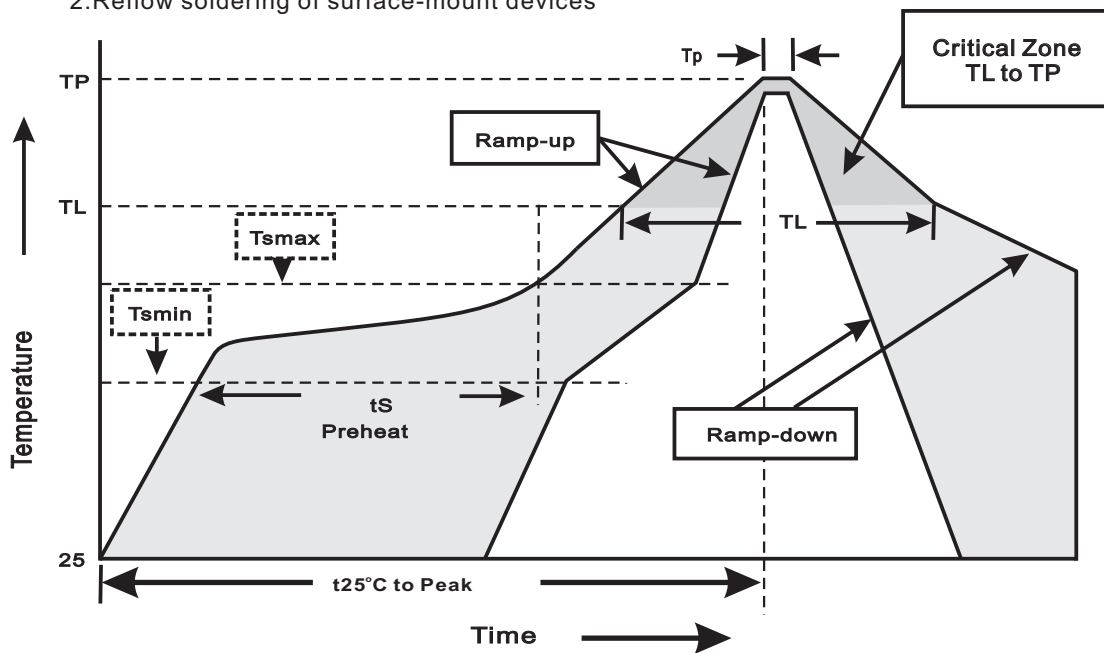

3.Reflow soldering

Profile Feature	Soldering Condition
Average ramp-up rate(T _L to T _P)	<3°C/sec
Preheat -Temperature Min(T _{smmin}) -Temperature Max(T _{smmax}) -Time(min to max)(t _s)	150°C 200°C 60~120sec
T _{smmax} to T _L -Ramp-upRate	<3°C/sec
Time maintained above: -Temperature(T _L) -Time(t _L)	217°C 60~260sec
Peak Temperature(T _P)	255°C-0/+5°C
Time within 5°C of actual Peak Temperature(t _P)	10~30sec
Ramp-down Rate	<6°C/sec
Time 25°C to Peak Temperature	<6minutes

FM140-MH1 THRU FM1200-MH1

High reliability test capabilities

Item Test	Conditions	Reference
1. Solder Resistance	at 260±5°C for 10±2sec. immerse body into solder 1/16"±1/32"	MIL-STD-750D METHOD-2031
2. Solderability	at 245±5°C for 5 sec.	MIL-STD-202F METHOD-208
3. High Temperature Reverse Bias	V _R =80% rate at T _J =125°C for 168 hrs.	MIL-STD-750D METHOD-1038
4. Forward Operation Life	Rated average rectifier current at T _A =25°C for 500hrs.	MIL-STD-750D METHOD-1027
5. Intermittent Operation Life	T _A = 25°C, I _F = I _O On state: power on for 5 min. off state: power off for 5 min. on and off for 500 cycles.	MIL-STD-750D METHOD-1036
6. Pressure Cooker	15P _{SIG} at T _A =121°C for 4 hrs.	JESD22-A102
7. Temperature Cycling	-55°C to +125°C dwelled for 30 min. and transferred for 5min. total 10 cycles.	MIL-STD-750D METHOD-1051
8. Forward Surge	8.3ms single half sine-wave , one surge.	MIL-STD-750D METHOD-4066-2
9. Humidity	at T _A =85°C, RH=85% for 1000hrs.	MIL-STD-750D METHOD-1021
10. High Temperature Storage Life	at 175°C for 1000 hrs.	MIL-STD-750D METHOD-1031