

# Thick Film Chip Resistors

## MCR Series

### ●Features

- 1) Full line up from ultra small size (01005) to 2512 with jumper type.
- 2) High reliability metal glazed thick film.
- 3) ROHM resistors have obtained ISO9001/ISO/TS16949 certification.
- 4) "Automotive" product is AEC-Q200 compliant.

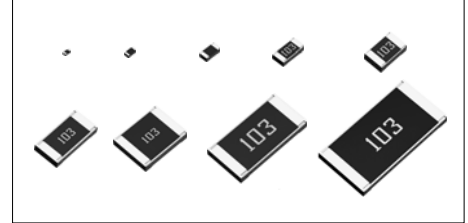

Part No.	Size		Type Code		Packing Specification	Quantity / Reel
	(mm)	(inch)	GENERAL PURPOSE	AUTOMOTIVE *Corresponds to AEC-Q200		
<b>MCR004</b>	0402	01005	YZP	–	Paper tape (2mm pitch)	15,000
			RZP	–	Embossed tape (1mm pitch)	40,000
<b>MCR006</b>	0603	0201	YRT	YZP	Paper tape (2mm pitch)	15,000
<b>MCR01</b>	1005	0402	MRT	MZP		10,000
PZPI (*For further information on datasheet, please refer to AUTOMOTIVE datasheet.)				Bulk case	50,000	
<b>MCR03</b>	1608	0603	ERT	EZP	Paper tape (4mm pitch)	5,000
			MZP / PZPI (*For further information on datasheet, please refer to AUTOMOTIVE datasheet.)		MZP : Paper tape (2mm pitch) PZPI : Bulk case	MZP : 10,000 PZPI : 25,000
<b>MCR10</b>	2012	0805	ERT	EZP	Paper tape (4mm pitch)	5,000
<b>MCR18</b>	3216	1206	ERT	EZP		
<b>MCR25</b>	3225	1210	JZH		Embossed tape (4mm pitch)	4,000
<b>MCR50</b>	5025	2010	JZH			
<b>MCR100</b>	6432	2512	JZH			

\*Please contact us for status of AEC-Q200 on "General purpose" products.

### ●Part Number Description

<b>M</b> <b>C</b> <b>R</b>	<b>0</b> <b>0</b> <b>6</b>	<b>Y</b> <b>R</b> <b>T</b>	<b>J</b>	<b>1</b> <b>0</b> <b>0</b>						
<b>Part No.</b> MCR (Micro chip resistors)	<b>Size (mm [inch])</b> 004 (0402 [01005]) 006 (0603 [0201]) 01 (1005 [0402]) 03 (1608 [0603]) 10 (2012 [0805]) 18 (3216 [1206]) 25 (3225 [1210]) 50 (5025 [2010]) 100 (6432 [2512])	<b>Type Code</b>	<b>Resistance Tolerance</b> D ( ±0.5% ) F ( ±1% ) FX ( ±1% ) *Only MCR03EZP/MZP/PZPI J ( ±5% ) (Including jumper type)	<b>Nominal Resistance</b> Resistance code, 3 or 4 digits. 000 denotes jumper type. <table border="1" style="width: 100%; border-collapse: collapse;"> <tr> <th>Resistance tolerance</th> <th>Resistance code</th> </tr> <tr> <td>D,F</td> <td>: 4 digits</td> </tr> <tr> <td>J</td> <td>: 3 digits</td> </tr> </table> Ex.) 1Ω = 1R0 ( ±5% ) 9.1Ω = 9R1 ( ±5% ) 10Ω = 10R0 ( ±0.5%,±1% ) 100 ( ±5% ) 2.2M Ω = 2204 ( ±1% ) 225 ( ±5% )	Resistance tolerance	Resistance code	D,F	: 4 digits	J	: 3 digits
Resistance tolerance	Resistance code									
D,F	: 4 digits									
J	: 3 digits									

## ●Products List

Part No.	Type Code	Rated Power (70°C) (W)	Limiting Element Voltage (V)	Maximum Overload Voltage (V)	Temperature Coefficient (ppm / °C)	Resistance Tolerance (%)	Resistance Range	Series	Operating Temperature Range (°C)	
MCR004	YZP, RZP	0.031	15	-	±600 / -200	J(±5%)	1.0Ω to 9.1Ω	E24	-55 to +125	
					±300		10Ω to 91Ω			
					±250		100Ω to 3MΩ			
Jumper type : Rmax = 50m Ω / Imax. = 0.5A										
MCR006	YRT	0.05	25	-	±600 / -200	J(±5%)	1.0Ω to 9.1Ω	E24		
					±250		10Ω to 10MΩ			
					±250	F(±1%)	10Ω to 10MΩ			
					±200	D(±0.5%)	10Ω to 1MΩ			
Jumper type : Rmax = 50m Ω / Imax. = 0.5A										
MCR01	MRT	0.063	50	-	+500 / -250	J(±5%)	1.0Ω to 9.1Ω	E24		
					±200		10Ω to 10MΩ			
					±100	F(±1%)	10Ω to 976kΩ	E24,E96		
					±200		1MΩ to 2.2MΩ			
					±100	D(±0.5%)	10Ω to 1MΩ	E24		
Jumper type : Rmax = 50m Ω / Imax. = 1A										
MCR03	ERT	0.1	50	100	±400	J(±5%)	1.0Ω to 9.1Ω	E24		
					±200		10Ω to 10MΩ			
					±100	F(±1%)	10Ω to 976kΩ	E24,E96		
					±200		1MΩ to 10MΩ			
					±100	D(±0.5%)	10Ω to 1MΩ			
Jumper type : Rmax = 50m Ω / Imax. = 1A										
MCR10	ERT	0.125	150	200	±400	J(±5%)	1.0Ω to 9.1Ω	E24		
					±200		10Ω to 10MΩ			
					±100	F(±1%)	10Ω to 976kΩ	E24,E96		
					±200		1MΩ to 2.2MΩ			
Jumper type : Rmax = 50m Ω / Imax. = 2A										
MCR18	ERT	0.25	200	400	±400	J(±5%)	1.0Ω to 9.1Ω	E24		
					±200		10Ω to 10MΩ			
					±100	F(±1%)	10Ω to 976kΩ	E24,E96		
					±200		1MΩ to 2.2MΩ			
Jumper type : Rmax = 50m Ω / Imax. = 2A										
MCR25	JZH	0.25	200	400	500±350	J(±5%)	1.0Ω to 2.0Ω	E24		
					±500		2.2Ω to 5.1Ω			
					±200		5.6Ω to 3.3MΩ			
					±100	F(±1%)	10Ω to 1MΩ	E24,E96		
Jumper type : Rmax = 50m Ω / Imax. = 2A										
MCR50	JZH	0.5	200	400	500±350	J(±5%)	1.0Ω to 2.0Ω	E24		
					±500		2.2Ω to 9.1Ω			
					±200		10Ω to 330kΩ			
					±350		360kΩ to 560kΩ			
					±100	F(±1%)	10Ω to 180kΩ	E24,E96		
Jumper type : Rmax = 50m Ω / Imax. = 3A										
MCR100	JZH	1	200	400	500±350	J(±5%)	1.0Ω to 2.0Ω	E24		
					±500		2.2Ω to 9.1Ω			
					±350		10Ω to 22Ω			
					±200		24Ω to 100kΩ			
					±100	F(±1%)	10Ω to 82kΩ	E24,E96		
Jumper type : Rmax = 50m Ω / Imax. = 4A										

\*Design and specifications are subject to change without notice. Carefully check the specification sheet supplied with the product before using or ordering it.

●Chip Resistor Dimensions and Markings

■ MCR004 / 006 / 01 / 03 ■ MCR10 / 18 / 25 / 50 / 100

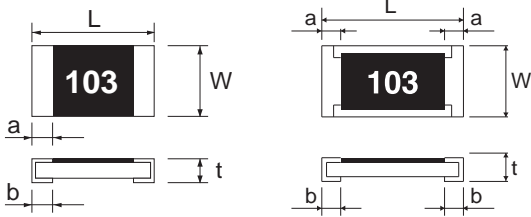

<Marking method>

There are three or four digits used for the calculation number according to IEC code and "R" is used for the decimal point.

(Unit : mm)

Part No.	Type Code	(mm)	(inch)	L	W	t	a	b	Marking existence
MCR004	YZP,RZP	0402	01005	0.4±0.02	0.2±0.02	0.13±0.02	0.1±0.03	0.1±0.03	No
MCR006	YRT	0603	0201	0.6±0.03	0.3±0.03	0.23±0.03	0.15±0.05	0.15±0.05	No
MCR01	MRT	1005	0402	1.0±0.05	0.5±0.05	0.35±0.05	0.2±0.1	0.25 <sup>+0.05</sup> <sub>-0.1</sub>	No
MCR03	ERT	1608	0603	1.6±0.1	0.8±0.1	0.45±0.1	0.3±0.2	0.3±0.2	Yes *
MCR10	ERT	2012	0805	2.0±0.1	1.25±0.1	0.5±0.1	0.35±0.2	0.35±0.2	Yes
MCR18	ERT	3216	1206	3.05±0.15	1.55±0.15	0.55±0.1	0.45±0.25	0.35±0.25	Yes
MCR25	JZH	3225	1210	3.2±0.15	2.5±0.15	0.55±0.15	0.5±0.25	0.5±0.25	Yes
MCR50	JZH	5025	2010	5.0±0.15	2.5±0.15	0.55±0.15	0.6±0.25	0.6±0.25	Yes
MCR100	JZH	6432	2512	6.3±0.15	3.2±0.15	0.55±0.15	0.6±0.25	0.6±0.25	Yes

Marking method of jumper type

Jumper type	Marking existence
MCR004 / 006 / 01 / 25 / 50 / 100	No
MCR03 / 10 / 18	Yes

\*Marking method of MCR03

The description of markings on the chip resistor are as shown below.

① Marking method (J class):

The nominal resistance is expressed in by E-24series 3 digits. The first 2 digits apply to the resistance value and the last one indicates the number of zeros to follow. The R is used as a decimal point.

Example : 100kΩ = 104

② Marking method (F/D class):

·For the resistance value contained in E96 series.

The nominal resistance is expressed in 3 digits. The first 2 digits is symbol to the resistance value and the last one is symbol to multipliers.

Example : 100kΩ = 01d (01d→100 × 10<sup>3</sup> = 100,000Ω = 100kΩ)

Example : 3.01kΩ = 47b (47b→301 × 10<sup>1</sup> = 3010Ω = 3.01kΩ)

·For the resistance value not contained in E96 series and contained in E-24 series.

The marking is expressed by E-24 series in 3 digits and one short bar under the last marking letter.

Example : 390Ω = 391

Symbol for E96 Series nominal resistance value

Symbol	E96	Symbol	E96	Symbol	E96	Symbol	E96
01	100	25	178	49	316	73	562
02	102	26	182	50	324	74	576
03	105	27	187	51	332	75	590
04	107	28	191	52	340	76	604
05	110	29	196	53	348	77	619
06	113	30	200	54	357	78	634
07	115	31	205	55	365	79	649
08	118	32	210	56	374	80	665
09	121	33	215	57	383	81	681
10	124	34	221	58	392	82	698
11	127	35	226	59	402	83	715
12	130	36	232	60	412	84	732
13	133	37	237	61	422	85	750
14	137	38	243	62	432	86	768
15	140	39	249	63	442	87	787
16	143	40	255	64	453	88	806
17	147	41	261	65	464	89	825
18	150	42	267	66	475	90	845
19	154	43	274	67	487	91	866
20	158	44	280	68	499	92	887
21	162	45	287	69	511	93	909
22	165	46	294	70	523	94	931
23	169	47	301	71	536	95	953
24	174	48	309	72	549	96	976

Symbol for multipliers

Symbol	A	b	C	d	E	F	X	Y
multipliers	10 <sup>0</sup>	10 <sup>1</sup>	10 <sup>2</sup>	10 <sup>3</sup>	10 <sup>4</sup>	10 <sup>5</sup>	10 <sup>-1</sup>	10 <sup>-2</sup>

●Land pattern Example

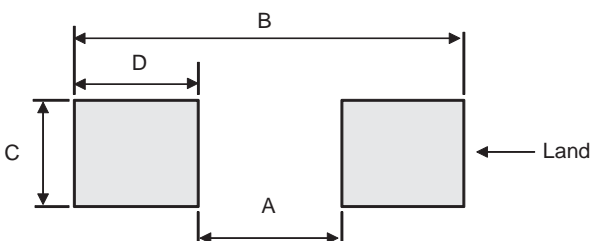

(Unit : mm)

Part No.	Type Code	A	B	C	D
MCR004	YZP,RZP	0.2	0.4	0.16	0.1
MCR006	YRT	0.3	0.84	0.3	0.27
MCR01	MRT	0.5	1.3	0.5	0.4
MCR03	ERT	1.0	2.0	0.8	0.5
MCR10	ERT	1.2	2.6	1.15	0.7
MCR18	ERT	2.2	4.0	1.5	0.9
MCR25	JZH	2.2	4.0	2.3	0.9
MCR50	JZH	3.8	6.0	2.3	1.1
MCR100	JZH	5.1	8.1	3.0	1.5

●Derating Curve

When the ambient temperature exceeds 70°C, power dissipation must be adjusted according to the derating curves below.

■ MCR004 / 006 / 100

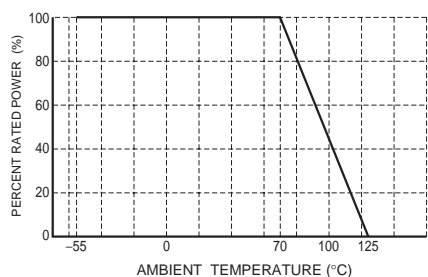

■ MCR01 / 03 / 10 / 18 / 25 / 50

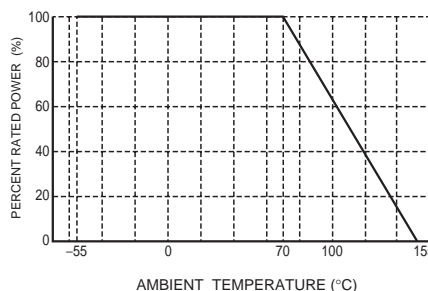

●Characteristics

Test Items	Guaranteed Value		Test Conditions
	Resistor Type	Jumper Type	
Resistance	See "Products List"		20°C
Variation of resistance with temperature	See "Products List"		Measurement : +20 / -55 / +20 / +125°C
Overload	± (2.0%+0.1Ω)	Max. 50mΩ	Rated voltage (current) ×2.5, 2s. Maximum overload voltage
Solderability	A new uniform coating of minimum of 95% of the surface being immersed and no soldering damage.		Rosin-Ethanol : 25% (Weight) Soldering condition : 235±5°C Duration of immersion : 2.0±0.5s
Resistance to soldering heat	± (1.0%+0.05Ω) No remarkable abnormality on the appearance.	Max. 50mΩ	Soldering condition : 260±5°C Duration of immersion : 10±1s
Rapid change of temperature	± (1.0%+0.05Ω)	Max. 50mΩ	Test temp. -55°C to +125°C 100cycle (MCR004 / 006) -55°C to +125°C 300cycle (MCR01) -55°C to +125°C 5cycle (MCR03 / 10 / 18 / 25 / 50 / 100)
Damp heat, steady state	± (3.0%+0.1Ω)	Max. 100mΩ	40°C, 93%RH (Relative Humidity) Test time : 1,000h to 1,048h
Endurance at 70°C	± (3.0%+0.1Ω)	Max. 100mΩ	70°C Rated voltage (current) 1.5h : ON – 0.5h : OFF Test time : 1,000h to 1,048h
Endurance	± (3.0%+0.1Ω)	Max. 100mΩ	125°C (MCR004 / 006 / 25 / 50 / 100) 155°C (MCR01 / 03 / 10 / 18) Test time : 1,000h to 1,048h
Resistance to solvent	± (1.0%+0.05Ω)	Max. 50mΩ	23±5°C, Immersion cleaning, 5±0.5min Solvent : 2-propanol
Bend strength of the end face plating	± (1.0%+0.05Ω) Without mechanical damage such as breaks.	Max. 50mΩ	-

Compliance Standard(s) : IEC60115-8  
JISC 5201-8

●Chip weight (typical value)

Parameter	Unit	MCR004 YZP / RZP	MCR006 YRT	MCR01 MRT	MCR03 ERT	MCR10 ERT	MCR18 ERT	MCR25 JZH	MCR50 JZH	MCR100 JZH
Weight	mg/pc	0.04	0.150	0.565	2.03	4.73	8.56	16.5	25.8	42.0

●Tape Dimensions

(Unit : mm)

■ Paper Tape

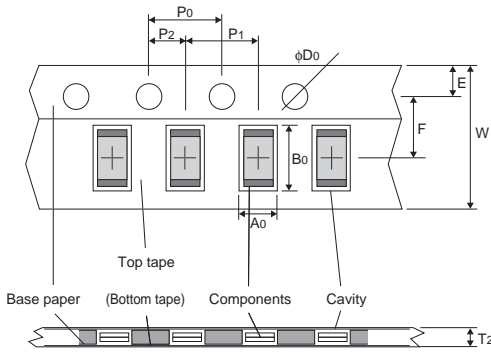

Part No.	Type Code	W	F	E	A <sub>0</sub>	B <sub>0</sub>
MCR004	YZP	8.0±0.2	3.5±0.05	1.75±0.1	0.24±0.03	0.45±0.03
MCR006	YRT	8.0±0.2	3.5±0.05	1.75±0.1	0.38±0.03	0.68±0.03
MCR01	MRT	8.0±0.3	3.5±0.05	1.75±0.1	0.7±0.1	1.2±0.1
MCR03	ERT	8.0±0.3	3.5±0.05	1.75±0.1	1.0±0.1	1.8±0.1
MCR10	ERT	8.0±0.3	3.5±0.05	1.75±0.1	1.55±0.1	2.3±0.1
MCR18	ERT	8.0±0.3	3.5±0.05	1.75±0.1	1.9±0.2	3.5±0.2

Part No.	Type Code	D <sub>0</sub>	P <sub>0</sub>	P <sub>1</sub>	P <sub>2</sub>	T <sub>2</sub>
MCR004	YZP	$\phi 1.5 \begin{smallmatrix} +0.1 \\ 0 \end{smallmatrix}$	4.0±0.1	2.0±0.05	2.0±0.05	Max 0.5
MCR006	YRT	$\phi 1.5 \begin{smallmatrix} +0.1 \\ 0 \end{smallmatrix}$	4.0±0.1	2.0±0.05	2.0±0.05	Max 0.5
MCR01	MRT	$\phi 1.5 \begin{smallmatrix} +0.1 \\ 0 \end{smallmatrix}$	4.0±0.1	2.0±0.1	2.0±0.05	Max 1.1
MCR03	ERT	$\phi 1.5 \begin{smallmatrix} +0.1 \\ 0 \end{smallmatrix}$	4.0±0.1	4.0±0.1	2.0±0.05	Max 1.1
MCR10	ERT	$\phi 1.5 \begin{smallmatrix} +0.1 \\ 0 \end{smallmatrix}$	4.0±0.1	4.0±0.1	2.0±0.05	Max 1.1
MCR18	ERT	$\phi 1.5 \begin{smallmatrix} +0.1 \\ 0 \end{smallmatrix}$	4.0±0.1	4.0±0.1	2.0±0.05	Max 1.1

■ Embossed Tape  
<MCR004>

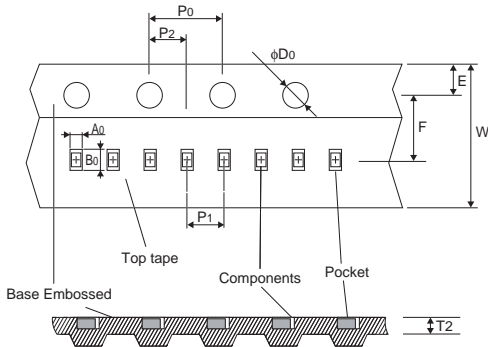

(Unit : mm)

Part No.	Type Code	W	F	E	A <sub>0</sub>	B <sub>0</sub>
MCR004	RZP	4.0±0.05	1.8±0.02	0.9±0.05	0.23±0.02	0.43±0.02
MCR25	JZH	8.0±0.3	3.5±0.05	1.75±0.1	3.0±0.1	3.5±0.1
MCR50	JZH	12±0.3	5.5±0.05	1.75±0.1	3.4±0.2	5.6±0.2
MCR100	JZH	12±0.3	5.5±0.05	1.75±0.1	3.5±0.2	6.7±0.2

Part No.	Type Code	D <sub>0</sub>	P <sub>0</sub>	P <sub>1</sub>	P <sub>2</sub>	T <sub>2</sub>
MCR004	RZP	$\phi 0.8 \pm 0.04$	2.0±0.04	1.0±0.02	1.0±0.02	0.2±0.02
MCR25	JZH	$\phi 1.5 \begin{smallmatrix} +0.1 \\ 0 \end{smallmatrix}$	4.0±0.1	4.0±0.1	2.0±0.05	Max 1.1
MCR50	JZH	$\phi 1.5 \begin{smallmatrix} +0.1 \\ 0 \end{smallmatrix}$	4.0±0.1	4.0±0.1	2.0±0.05	Max 1.1
MCR100	JZH	$\phi 1.5 \begin{smallmatrix} +0.1 \\ 0 \end{smallmatrix}$	4.0±0.1	4.0±0.1	2.0±0.05	Max 1.1

<MCR25 / 50 / 100>

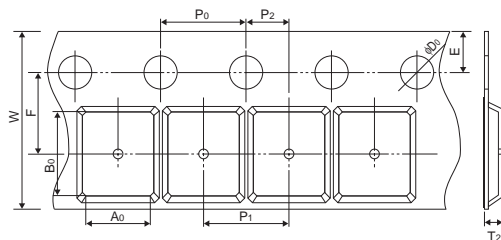

●Reel Dimensions

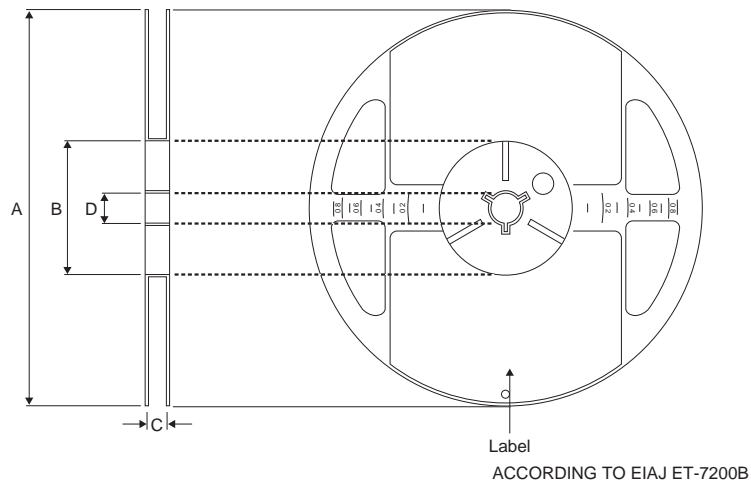

(Unit : mm)

Part No.	Type Code	A	B	C	D
MCR004	YZP	$\phi 180 \begin{matrix} 0 \\ -1.5 \end{matrix}$	$\phi 60 \begin{matrix} +1.0 \\ 0 \end{matrix}$	$9 \begin{matrix} +1.0 \\ 0 \end{matrix}$	$\phi 13 \pm 0.2$
MCR006	YRT				
MCR01	MRT				
MCR03	ERT				
MCR10	ERT				
MCR18	ERT			$13 \begin{matrix} +1.0 \\ 0 \end{matrix}$	
MCR25	JZH				
MCR50	JZH				
MCR100	JZH				

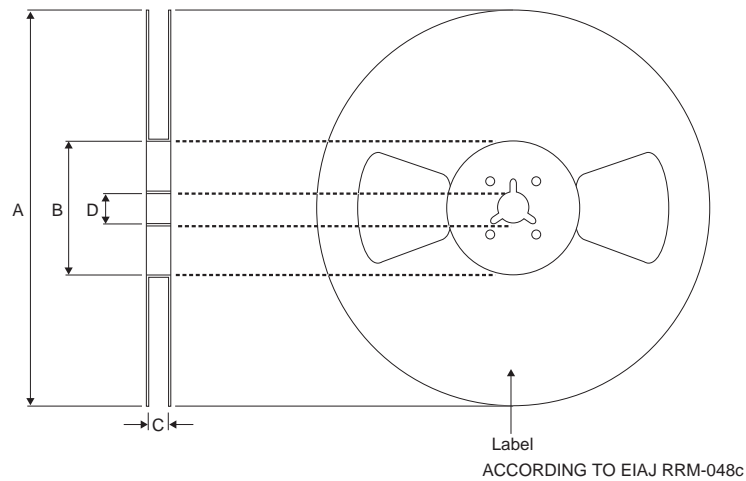

(Unit : mm)

Part No.	Type Code	A	B	C	D
MCR004	RZP	$\phi 178 \pm 1.0$	$\phi 60 \pm 1.0$	$5 \begin{matrix} +1.0 \\ -0.6 \end{matrix}$	$\phi 13 \pm 0.2$

## ●Products List

Part No.	Type Code	Rated Power (70°C) (W)	Limiting Element Voltage (V)	Maximum Overload Voltage (V)	Temperature Coefficient (ppm / °C)	Resistance Tolerance (%)	Resistance Range	Series	Operating Temperature Range (°C)
MCR006	YZP	0.05	25	-	+600 / -200 ±250	J(±5%)	1.0Ω to 9.1Ω 10Ω to 10MΩ	E24	-55 to +125
					±250	F(±1%)	10Ω to 10MΩ		
					±200	D(±0.5%)	10Ω to 910Ω 1kΩ to 1MΩ		
					±100				
Jumper type : Rmax = 50mΩ / Imax. = 0.5A									
MCR01	MZP PZPI	0.063	50	-	+500 / -250 ±200	J(±5%)	1.0Ω to 9.1Ω 10Ω to 10MΩ	E24	
					±100	F(±1%)	10Ω to 2.2MΩ	E24,E96	
					±100	D(±0.5%)	10Ω to 91Ω 100Ω to 1MΩ	E24	
					±50				
Jumper type : Rmax = 50mΩ / Imax. = 1A									
MCR03	EZP MZP PZPI	0.1	50	100	±400 ±200	J(±5%)	1.0Ω to 9.1Ω 10Ω to 10MΩ	E24	
					±100	FX(±1%)	10Ω to 10MΩ	E24,E96	
					±100	D(±0.5%)	10Ω to 91Ω 100Ω to 1MΩ		
					±50				
Jumper type : Rmax = 50mΩ / Imax. = 1A									
MCR10	EZP	0.125	150	200	±400 ±200	J(±5%)	1.0Ω to 9.1Ω 10Ω to 10MΩ	E24	
		0.1			±100	F(±1%)	10Ω to 2.2MΩ	E24,E96	
					±100	D(±0.5%)	10Ω to 91Ω 100Ω to 1MΩ		
		±50							
Jumper type : Rmax = 50mΩ / Imax. = 2A									
MCR18	EZP	0.25	200	400	±400 ±200	J(±5%)	1.0Ω to 9.1Ω 10Ω to 10MΩ	E24	-55 to +155
		0.125			±100	F(±1%)	10Ω to 2.2MΩ	E24,E96	
					±100	D(±0.5%)	10Ω to 91Ω 100Ω to 1MΩ		
		±50							
Jumper type : Rmax = 50mΩ / Imax. = 2A									
MCR25	JZH	0.25	200	400	500±350 ±500	J(±5%)	1.0Ω to 2.0Ω 2.2Ω to 5.1Ω 5.6Ω to 3.3MΩ	E24	
					±200	F(±1%)	10Ω to 1MΩ	E24,E96	
					±100				
Jumper type : Rmax = 50mΩ / Imax. = 2A									
MCR50	JZH	0.5	200	400	500±350 ±500	J(±5%)	1.0Ω to 2.0Ω 2.2Ω to 9.1Ω 10Ω to 330kΩ 360kΩ to 560kΩ	E24	
					±200	F(±1%)	10Ω to 180kΩ	E24,E96	
					±350				
					±100				
Jumper type : Rmax = 50mΩ / Imax. = 3A									
MCR100	JZH	1	200	400	500±350 ±500	J(±5%)	1.0Ω to 2.0Ω 2.2Ω to 9.1Ω 10Ω to 22Ω 24Ω to 100kΩ	E24	-55 to +125
					±350	F(±1%)	10Ω to 82kΩ	E24,E96	
					±200				
					±100				
Jumper type : Rmax = 50mΩ / Imax. = 4A									

\*Design and specifications are subject to change without notice. Carefully check the specification sheet supplied with the product before using or ordering it.

●Chip Resistor Dimensions and Markings

■ MCR004 / 006 / 01 / 03 ■ MCR10 / 18 / 25 / 50 / 100

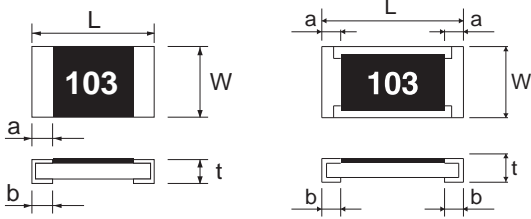

<Marking method>

There are three or four digits used for the calculation number according to IEC code and "R" is used for the decimal point.

(Unit : mm)

Part No.	Type Code	(mm)	(inch)	L	W	t	a	b	Marking existence
MCR006	YZP	0603	0201	0.6±0.03	0.3±0.03	0.23±0.03	0.1±0.05	0.15±0.05	No
MCR01	MZP PZPI	1005	0402	1.0±0.05	0.5±0.05	0.35±0.05	0.2±0.1	0.25 <sup>+0.05</sup> <sub>-0.1</sub>	No
MCR03	EZP MZP PZPI	1608	0603	1.6±0.1	0.8±0.1	0.45±0.1	0.3±0.2	0.3±0.2	Yes *
MCR10	EZP	2012	0805	2.0±0.1	1.25±0.1	0.55±0.1	0.4±0.2	0.4±0.2	Yes
MCR18	EZP	3216	1206	3.2±0.15	1.6±0.15	0.55±0.1	0.5±0.25	0.5±0.25	Yes
MCR25	JZH	3225	1210	3.2±0.15	2.5±0.15	0.55±0.15	0.5±0.25	0.5±0.25	Yes
MCR50	JZH	5025	2010	5.0±0.15	2.5±0.15	0.55±0.15	0.6±0.25	0.6±0.25	Yes
MCR100	JZH	6432	2512	6.3±0.15	3.2±0.15	0.55±0.15	0.6±0.25	0.6±0.25	Yes

Marking method of jumper type

Jumper type	Marking existence
MCR006 / 01 / 25 / 50 / 100	No
MCR03 / 10 / 18	Yes

\*Marking method of MCR03

For MCR03 series resistors, the printing process restricts the marking to three digits/characters.

Consequently, 1% tolerance resistors with values from the E24 series will be marked the same as

5% resistors with the same value, but 1% tolerance resistors with values from the E96 series will not be marked.

Examples:

MCR03EZPJ243 (5% tolerance, E24 / 24 k Ω) Marking = 243

MCR03EZPF2402 (1% tolerance, E24 / 24 k Ω) Marking = 243

MCR03EZPF2432 (1% tolerance, E96 / 24.3 k Ω) No Marking

MCR18EZPJ243 (5% tolerance, E24 / 24 k Ω) Marking = 243

MCR18EZPF2402 (1% tolerance, E24 / 24 k Ω) Marking = 2402

MCR18EZPF2432 (1% tolerance, E96 / 24.3 k Ω) Marking = 2432

●Land pattern Example

(Unit : mm)

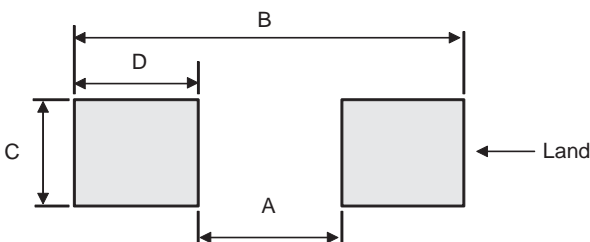

Part No.	Dimensions Type Code	Dimensions			
		A	B	C	D
MCR006	YZP	0.3	0.84	0.3	0.27
MCR01	MZP PZPI	0.5	1.3	0.5	0.4
MCR03	EZP MZP PZPI	1.0	2.0	0.8	0.5
MCR10	EZP	1.2	2.6	1.15	0.7
MCR18	EZP	2.2	4.0	1.5	0.9
MCR25	JZH	2.2	4.0	2.3	0.9
MCR50	JZH	3.8	6.0	2.3	1.1
MCR100	JZH	5.1	8.1	3.0	1.5



●Derating Curve

When the ambient temperature exceeds 70°C, power dissipation must be adjusted according to the derating curves below.

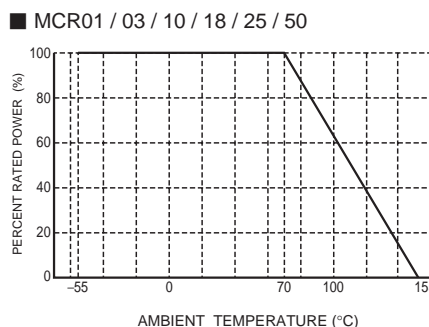
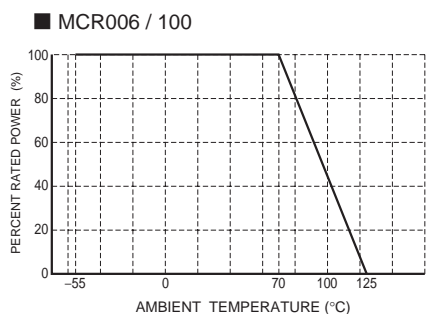

●Characteristics

Test Items	Guaranteed Value		Test Conditions
	Resistor Type	Jumper Type	
Resistance	See "Products List"		20°C
Variation of resistance with temperature	See "Products List"		Measurement : +20 / -55 / +20 / +125°C
Overload	± (2.0%+0.1Ω)	Max. 50mΩ	Rated voltage (current) ×2.5, 2s. Maximum overload voltage
Solderability	A new uniform coating of minimum of 95% of the surface being immersed and no soldering damage.		Rosin-Ethanol : 25% (Weight) Soldering condition : 235±5°C Duration of immersion : 2.0±0.5s
Resistance to soldering heat	± (1.0%+0.05Ω) No remarkable abnormality on the appearance.	Max. 50mΩ	Soldering condition : 260±5°C Duration of immersion : 10±1s
Rapid change of temperature	± (1.0%+0.05Ω)	Max. 50mΩ	Test temp. -55°C to +125°C 100cycle (MCR006 / 01 / 03) -55°C to +125°C 5cycle (MCR10 / 18 / 25 / 50 / 100)
Damp heat, steady state	± (3.0%+0.1Ω)	Max. 100mΩ	40°C, 93%RH (Relative Humidity) Test time : 1,000h to 1,048h
Endurance at 70°C	± (3.0%+0.1Ω)	Max. 100mΩ	70°C Rated voltage (current) 1.5h : ON – 0.5h : OFF Test time : 1,000h to 1,048h
Endurance	± (3.0%+0.1Ω)	Max. 100mΩ	125°C (MCR006 / 25 / 50 / 100) 155°C (MCR01 / 03 / 10 / 18) Test time : 1,000h to 1,048h
Resistance to solvent	± (1.0%+0.05Ω)	Max. 50mΩ	23±5°C, Immersion cleaning, 5±0.5min Solvent : 2-propanol
Bend strength of the end face plating	± (1.0%+0.05Ω) Without mechanical damage such as breaks.	Max. 50mΩ	-

Compliance Standard(s) : IEC60115-8  
JISC 5201-8

●Chip weight (typical value)

Parameter	Unit	MCR006 YZP	MCR01 MZP / PZPI	MCR03 EZP / MZP / PZPI	MCR10 EZP	MCR18 EZP	MCR25 JZH	MCR50 JZH	MCR100 JZH
Weight	mg/pc	0.157	0.70	2.12	5.03	9.46	16.5	25.8	42.0

●Tape Dimensions

■ Paper Tape

(Unit : mm)

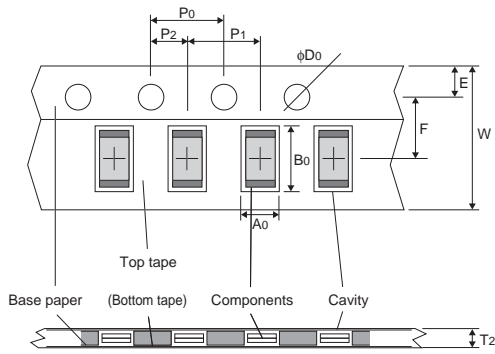

Part No.	Type Code	W	F	E	A0	B0
MCR006	YZP	8.0±0.2	3.5±0.05	1.75±0.1	0.38±0.03	0.68±0.03
MCR01	MZP	8.0±0.3	3.5±0.05	1.75±0.1	0.7±0.1	1.2±0.1
MCR03	EZP	8.0±0.3	3.5±0.05	1.75±0.1	1.1±0.1	1.9±0.1
MCR10	EZP	8.0±0.3	3.5±0.05	1.75±0.1	1.65 <sup>+0.2</sup> <sub>-0.1</sub>	2.4 <sup>+0.2</sup> <sub>-0.1</sub>
MCR18	EZP	8.0±0.3	3.5±0.05	1.75±0.1	1.95 <sup>+0.1</sup> <sub>-0.05</sub>	3.5 <sup>+0.15</sup> <sub>-0.05</sub>

Part No.	Type Code	D0	P0	P1	P2	T2
MCR006	YZP	φ1.5 <sup>+0.1</sup> <sub>0</sub>	4.0±0.1	2.0±0.05	2.0±0.05	Max 0.5
MCR01	MZP	φ1.5 <sup>+0.1</sup> <sub>0</sub>	4.0±0.1	2.0±0.05	2.0±0.05	Max 1.1
MCR03	EZP	φ1.5 <sup>+0.1</sup> <sub>0</sub>	4.0±0.1	4.0±0.1	2.0±0.05	Max 1.1
MCR10	EZP	φ1.5 <sup>+0.1</sup> <sub>0</sub>	4.0±0.1	4.0±0.1	2.0±0.05	Max 1.1
MCR18	EZP	φ1.5 <sup>+0.1</sup> <sub>0</sub>	4.0±0.1	4.0±0.1	2.0±0.05	Max 1.1

■ Paper Tape (Narrow pitch taping)

(Unit : mm)

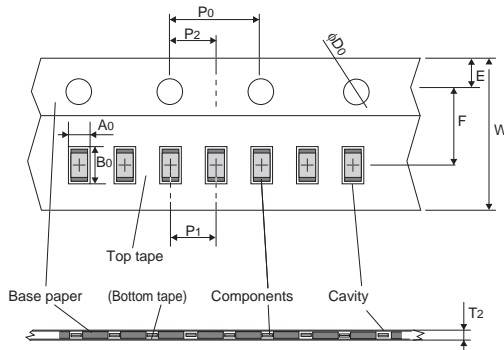

Part No.	Type Code	W	F	E	A0	B0
MCR03	MZP	8.0±0.3	3.5±0.05	1.75±0.1	1.1±0.1	1.9±0.1
		D0	P0	P1	P2	T2
		φ1.5 <sup>+0.1</sup> <sub>0</sub>	4.0±0.1	2.0±0.5	2.0±0.05	Max 1.1

■ Embossed Tape

(Unit : mm)

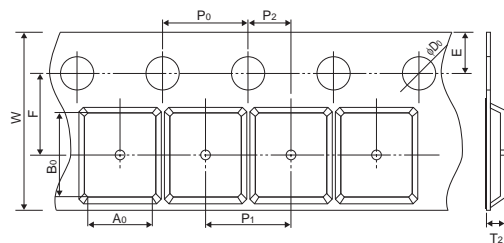

Part No.	Type Code	W	F	E	A0	B0
MCR25	JZH	8.0±0.3	3.5±0.05	1.75±0.1	3.0±0.1	3.5±0.1
MCR50	JZH	12±0.3	5.5±0.05	1.75±0.1	3.4±0.2	5.6±0.2
MCR100	JZH	12±0.3	5.5±0.05	1.75±0.1	3.5±0.2	6.7±0.2

Part No.	Type Code	D0	P0	P1	P2	T2
MCR25	JZH	φ1.5 <sup>+0.1</sup> <sub>0</sub>	4.0±0.1	4.0±0.1	2.0±0.05	Max 1.1
MCR50	JZH	φ1.5 <sup>+0.1</sup> <sub>0</sub>	4.0±0.1	4.0±0.1	2.0±0.05	Max 1.1
MCR100	JZH	φ1.5 <sup>+0.1</sup> <sub>0</sub>	4.0±0.1	4.0±0.1	2.0±0.05	Max 1.1

●Reel Dimensions

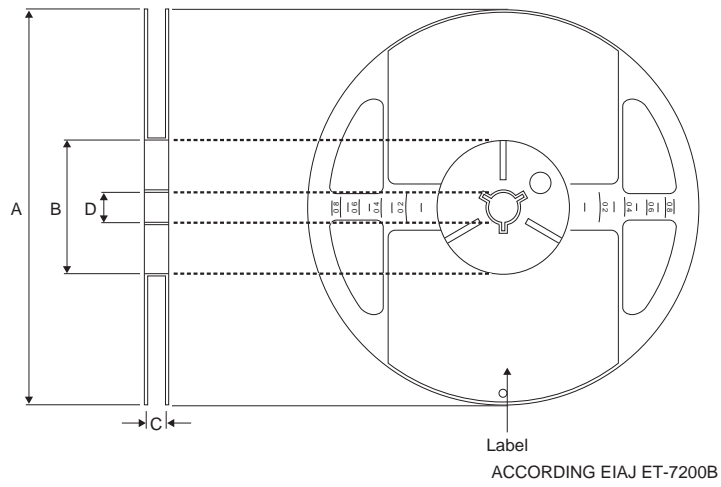

(Unit : mm)

Part No.	Type Code	A	B	C	D
MCR006	YZP	$\phi 180 \begin{matrix} 0 \\ -1.5 \end{matrix}$	$\phi 60 \begin{matrix} +1.0 \\ 0 \end{matrix}$	$9 \begin{matrix} +1.0 \\ 0 \end{matrix}$	$\phi 13 \pm 0.2$
MCR01	MZP				
MCR03	EZP MZP				
MCR10	EZP				
MCR18	EZP				
MCR25	JZH			$13 \begin{matrix} +1.0 \\ 0 \end{matrix}$	
MCR50	JZH				
MCR100	JZH				

●Bulk case Dimensions

- MCR01PZPI
- MCR03PZPI

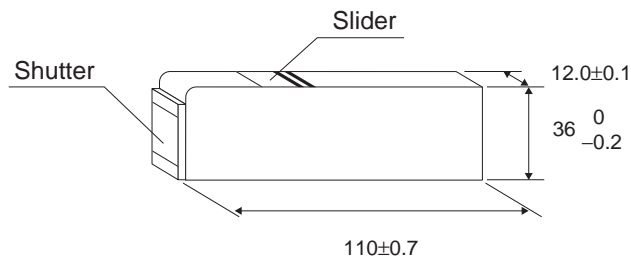

EIAJ ET-7200B compliant

(Unit : mm)

## Notes

No copying or reproduction of this document, in part or in whole, is permitted without the consent of ROHM Co.,Ltd.

The content specified herein is subject to change for improvement without notice.

The content specified herein is for the purpose of introducing ROHM's products (hereinafter "Products"). If you wish to use any such Product, please be sure to refer to the specifications, which can be obtained from ROHM upon request.

Examples of application circuits, circuit constants and any other information contained herein illustrate the standard usage and operations of the Products. The peripheral conditions must be taken into account when designing circuits for mass production.

Great care was taken in ensuring the accuracy of the information specified in this document. However, should you incur any damage arising from any inaccuracy or misprint of such information, ROHM shall bear no responsibility for such damage.

The technical information specified herein is intended only to show the typical functions of and examples of application circuits for the Products. ROHM does not grant you, explicitly or implicitly, any license to use or exercise intellectual property or other rights held by ROHM and other parties. ROHM shall bear no responsibility whatsoever for any dispute arising from the use of such technical information.

The Products specified in this document are intended to be used with general-use electronic equipment or devices (such as audio visual equipment, office-automation equipment, communication devices, electronic appliances and amusement devices).

The Products specified in this document are not designed to be radiation tolerant.

While ROHM always makes efforts to enhance the quality and reliability of its Products, a Product may fail or malfunction for a variety of reasons.

Please be sure to implement in your equipment using the Products safety measures to guard against the possibility of physical injury, fire or any other damage caused in the event of the failure of any Product, such as derating, redundancy, fire control and fail-safe designs. ROHM shall bear no responsibility whatsoever for your use of any Product outside of the prescribed scope or not in accordance with the instruction manual.

The Products are not designed or manufactured to be used with any equipment, device or system which requires an extremely high level of reliability the failure or malfunction of which may result in a direct threat to human life or create a risk of human injury (such as a medical instrument, transportation equipment, aerospace machinery, nuclear-reactor controller, fuel-controller or other safety device). ROHM shall bear no responsibility in any way for use of any of the Products for the above special purposes. If a Product is intended to be used for any such special purpose, please contact a ROHM sales representative before purchasing.

If you intend to export or ship overseas any Product or technology specified herein that may be controlled under the Foreign Exchange and the Foreign Trade Law, you will be required to obtain a license or permit under the Law.



Thank you for your accessing to ROHM product informations.  
More detail product informations and catalogs are available, please contact us.

## ROHM Customer Support System

<http://www.rohm.com/contact/>